

This document is made available through the declassification efforts
and research of John Greenewald, Jr., creator of:

The Black Vault



The Black Vault is the largest online Freedom of Information Act (FOIA)
document clearinghouse in the world. The research efforts here are
responsible for the declassification of hundreds of thousands of pages
released by the U.S. Government & Military.

Discover the Truth at: <http://www.theblackvault.com>



U.S. Department
of Transportation

**Federal Aviation
Administration**

Order 7110.65P

Air Traffic Control



Orlando Airport Traffic Control Tower

An electronic version of this publication is on the internet at
<http://www.faa.gov/atpubs>

Air Traffic Control

7110.65P

Foreword

This order prescribes air traffic control procedures and phraseology for use by personnel providing air traffic control services. Controllers are required to be familiar with the provisions of this order that pertain to their operational responsibilities and to exercise their best judgment if they encounter situations not covered by it.

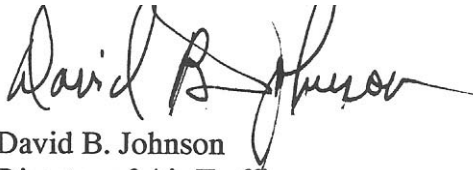

David B. Johnson
Director of Air Traffic

Date: November 3, 2003

SUBJ: AIR TRAFFIC CONTROL

- 1. PURPOSE.** This change transmits revised pages to Order 7110.65P, Air Traffic Control, and a Briefing Guide.
- 2. DISTRIBUTION.** This change is distributed to select offices in Washington headquarters, regional offices, the William J. Hughes Technical Center, and the Mike Monroney Aeronautical Center; all air traffic field facilities and international aviation field offices; and interested aviation public.
- 3. EFFECTIVE DATE.** August 4, 2005.
- 4. EXPLANATION OF CHANGES.** See the Explanation of Changes attachment which has editorial corrections and changes submitted through normal procedures. The Briefing Guide lists only new or modified material, along with background and operational impact statements.
- 5. DISPOSITION OF TRANSMITTAL.** Retain this transmittal until superseded by a new basic order.
- 6. PAGE CONTROL CHART.** See the Page Control Chart attachment.



Michael A. Cirillo
Vice President, System Operations Services

Date: May 10, 2005

Air Traffic Control Explanation of Changes

Direct questions through appropriate facility/region staff to the Office of Primary Interest (OPI)

a. 1-2-6. ABBREVIATIONS

The Enhanced Direct Access Radar Channel (EDARC) program is listed in Table 1-2-1 along with Direct Access Radar Channel (DARC). The enhancement program was completed and all remaining references to it are now being deleted. EAS, En Route Automation System, is added to reference the entire computer complex and associated software that makes up the air route traffic control center automation system.

Adds the following to Table 1-2-1:

Abbreviation	Meaning
EAS	En Route Automation System

Deletes the following from Table 1-2-1:

Abbreviation	Meaning
EDARC	Enhanced Direct Access Radar Channel

b. 2-1-6. SAFETY ALERT

From an operational and human factors point of view, safety-related advisories to aircraft should be standardized. By stating the alert first, the controller gains the attention of all aircraft on the frequency and the affected pilots have a greater probability of correctly hearing their call sign and reacting accordingly. Hear back errors are potentially reduced.

c. 2-1-7. INFLIGHT EQUIPMENT MALFUNCTIONS

Modifies the note to include RVSM provisions when defining inflight equipment malfunctions, their effect, and the reports controllers may expect from pilots when they occur. Cancels and incorporates N7110.397, Domestic Reduced Vertical Separation Minimum (DRVSM).

d. 2-1-13. FORMATION FLIGHTS

Adds procedures for equipment suffix changes for formation flights. Cancels and incorporates N7110.397, Domestic Reduced Vertical Separation Minimum (DRVSM).

e. 2-1-28. RVSM OPERATIONS

Adds controller responsibilities regarding aircraft flying in RVSM airspace. Cancels and incorporates N7110.397, Domestic Reduced Vertical Separation Minimum (DRVSM).

f. 2-2-2. FORWARDING INFORMATION

References to NAS Stage A operations are changed to En Route Automation System (EAS) flight data processing (FDP) operations to more accurately reflect the system function intended.

g. 2-2-6. IFR FLIGHT PROGRESS DATA

References to host computer and host are changed to EAS to more accurately reflect the system function intended.

h. 2-2-9. COMPUTER MESSAGE VERIFICATION

References to host are changed to EAS to more accurately reflect the system function intended.

i. 2-2-11. FORWARDING AMENDED AND UTM DATA

References to NAS Stage A and CRD are changed to En Route Automation System (EAS) FDP and computer update to more accurately reflect the system function intended.

j. 2-3-7. AIRCRAFT EQUIPMENT SUFFIX

Updates the Aircraft Equipment Suffix Table definition of "/Q" and eliminates the prohibition of users filing "/Q" in block 3 of FAA Flight Plan (Aircraft Type/Special Equipment). "/Q" will indicate that the aircraft has both RVSM and advanced RNAV capabilities. Cancels and incorporates N7110.397, Domestic Reduced Vertical Separation Minimum (DRVSM).

k. 4-4-6. DIRECT CLEARANCES

Requires controllers to only issue direct clearances within specific guidelines.

l. 4-5-1. VERTICAL SEPARATION MINIMA

Incorporates the reduction from 2,000 feet separation between FL 290 and FL 410 to 1,000 feet as a result of RVSM implementation. Cancels and incorporates N7110.397, Domestic Reduced Vertical Separation Minimum (DRVSM).

m. 4-5-2. FLIGHT DIRECTION

Incorporates the additional altitudes available under RVSM into the altitude assignment scheme. Cancels and incorporates N7110.397, Domestic Reduced Vertical Separation Minimum (DRVSM).

n. 4-5-3. EXCEPTIONS

Incorporates the additional altitudes assignable under RVSM when specific conditions require use beyond the normal right altitude for direction of flight assignment scheme. Cancels and incorporates N7110.397, Domestic Reduced Vertical Separation Minimum (DRVSM).

o. 5-1-2. ALIGNMENT ACCURACY CHECK

References to narrowband mode (Stage A), EDARC, DARC, HOST and PVD are deleted. Reference to RDP is made to more accurately reflect the system function intended.

p. 5-1-6. SERVICE LIMITATIONS

References to Stage A and DARC are deleted. Reference to EAS RDP is made to more accurately reflect the system function intended.

q. 5-1-8. MERGING TARGET PROCEDURES

Defines merging target procedures in RVSM airspace. Cancels and incorporates N7110.397, Domestic Reduced Vertical Separation Minimum (DRVSM).

r. 5-1-11. RADAR FIX POSTING

References to HOST/DARC and EARTS are changed to EAS to more accurately reflect the system function intended.

s. 5-4-3. METHODS

References to HOST, EDARC, DARC, etc., are changed to primary RDP, FDP, and backup RDP to more accurately reflect the system function intended.

t. 5-5-7. PASSING OR DIVERGING

Expands the use of passing or diverging courses when other approved separation is assured before the application of the conditions set forth in subparagraphs a1 and a2. Incorporates and cancels N7110.385, FAA Order 7110.65, Paragraph 5-5-7, Passing or Diverging, dated August 5, 2004.

u. 5-5-8. ADDITIONAL SEPARATION FOR FORMATION FLIGHTS

Adds note that formation flights are considered non-RVSM flights for separation purposes. Cancels and incorporates N7110.397, Domestic Reduced Vertical Separation Minimum (DRVSM).

v. 5-14-2. EN ROUTE MINIMUM SAFE ALTITUDE WARNING (E-MSAW)

Amends subparagraph a deleting the option to take appropriate action. Additionally, the new backup RDP now has E-MSAW capability.

w. 5-14-3. COMPUTER ENTRY OF ASSIGNED ALTITUDE

The reference to EARTS is obsolete and is removed.

x. 5-14-5. SELECTED ALTITUDE LIMITS

The section applies to all en route systems, including MEARTS, so references to EARTS, NAS Stage A, PVD/MDM and DARC are deleted to simplify the paragraph. It is also made consistent with Order 7210.3, Facility Operation and Administration, Paragraph 8-3-3, Selected Altitude Limits.

y. 9-5-4. SEPARATION MINIMA

The change to 1,000 feet separation up to FL 410 requires modification to the separation criteria for aircraft in the vicinity of a fuel dumping activity. Cancels and incorporates N7110.397, Domestic Reduced Vertical Separation Minimum (DRVSM).

z. 13-1-14. HOST OUTAGES

References to Host are changed to primary RDP/FDP to more accurately reflect the system function intended. Reference to EDARC is changed to backup RDP. Also, paragraph title is changed to Primary RDP/FDP Outages.

aa. APPENDIX A. AIRCRAFT INFORMATION

Replaces appendix A in its entirety. Aircraft are added and corrections made to current information. A weight class correction is made for the Saab 340 (SF34). Also, adds information on aircraft landing distances for the purposes of FAA Order 7110.118, Land and Hold Short Operations (LAHSO), to the performance data by including the LAHSO aircraft group for applicable aircraft. There are also minor editorial changes.

ab. Editorial/format changes were made where necessary. Revision bars were not used due to the insignificant nature of the changes.

PAGE CONTROL CHART**7110.65P CHG 3****August 4, 2005**

REMOVE PAGES	DATED	INSERT PAGES	DATED
Table of Contents i and ii	2/19/04	Table of Contents i and ii	8/4/05
Table of Contents iii	2/17/05	Table of Contents iii	8/4/05
Table of Contents iv	8/5/04	Table of Contents iv	8/5/04
Table of Contents vii	8/5/04	Table of Contents vii	8/4/05
Table of Contents viii	8/5/04	Table of Contents viii	8/5/04
Table of Contents ix	8/5/04	Table of Contents ix	8/4/05
Table of Contents x	2/17/05	Table of Contents x	8/4/05
Table of Contents xi and xii	2/19/04	Table of Contents xi and xii	8/4/05
Table of Contents xix	2/17/05	Table of Contents xix	2/17/05
Table of Contents xx	2/17/05	Table of Contents xx	8/4/05
1-2-3	2/17/05	1-2-3	2/17/05
1-2-4	8/5/04	1-2-4	8/4/05
1-2-5	2/17/05	1-2-5	2/17/05
1-2-6	2/17/05	1-2-6	8/4/05
2-1-3	8/5/04	2-1-3	8/4/05
2-1-4	2/19/04	2-1-4	8/4/05
2-1-5	2/19/04	2-1-5	2/19/04
2-1-6	8/5/04	2-1-6	8/4/05
2-1-7 through 2-1-12	2/19/04	2-1-7 through 2-1-12	8/4/05
2-2-1 through 2-2-5	2/19/04	2-2-1 through 2-2-5	8/4/05
2-3-9	8/5/04	2-3-9	8/5/04
2-3-10	8/5/04	2-3-10	8/4/05
4-2-1	2/19/04	4-2-1	2/19/04
4-2-2	8/5/04	4-2-2	8/4/05
4-4-3	8/5/04	4-4-3	8/4/05
4-5-1 and 4-5-2	8/5/04	4-5-1 and 4-5-2	8/4/05
5-1-1	2/19/04	5-1-1	8/4/05
5-1-2 and 5-1-3	8/5/04	5-1-2 and 5-1-3	8/4/05
5-1-4	2/19/04	5-1-4 and 5-1-5	8/4/05
5-2-7	2/19/04	5-2-7	2/19/04
5-2-8	2/19/04	5-2-8	8/4/05
5-4-1 through 5-4-4	2/19/04	5-4-1 through 5-4-4	8/4/05
5-4-5 and 5-4-6	2/17/05	5-4-5 and 5-4-6	8/4/05
5-5-3	2/19/04	5-5-3	2/19/04
5-5-4	8/5/04	5-5-4	8/4/05
5-5-5 and 5-5-6	2/19/04	5-5-5 and 5-5-6	8/4/05
5-14-1 through 5-14-3	2/19/04	5-14-1 through 5-14-3	8/4/05
9-3-5	2/17/05	9-3-5	8/4/05
9-3-6	8/5/04	9-3-6	8/5/04
9-5-1	2/19/04	9-5-1	8/4/05

REMOVE PAGES	DATED	INSERT PAGES	DATED
10-1-1	2/19/04	10-1-1	2/19/04
10-1-2	2/19/04	10-1-2	8/4/05
13-1-3	2/19/04	13-1-3	8/4/05
A-1	2/19/04	A-1	8/4/05
A-2 through A-16	8/5/04	A-2 through A-16	8/4/05
A-17 through A-24	2/19/04	A-17 through A-24	8/4/05
A-25	8/5/04	A-25	8/4/05
A-26 through A-28	2/19/04	A-26 through A-30	8/4/05
PCG-1	2/17/05	PCG-1	8/4/05
PCG A-3	2/17/05	PCG A-3	2/17/05
PCG A-4 through A-6	2/17/05	PCG A-4 through A-6	8/4/05
PCG A-9	2/17/05	PCG A-9	8/4/05
PCG A-10 and A-11	8/5/04	PCG A-10 and A-11	8/4/05
PCG A-12	8/5/04	PCG A-12	8/5/04
PCG A-15 and A-16	2/17/05	PCG A-15 and A-16	8/4/05
PCG D-1 through D-4	2/19/04	PCG D-1 through D-4	8/4/05
PCG E-1 and E-2	8/5/04	PCG E-1 and E-2	8/4/05
PCG N-1 through N-4	2/17/05	PCG N-1 through N-4	8/4/05
PCG P-1 through P-4	8/5/04	PCG P-1 through P-4	8/4/05
PCG Q-1	8/5/04	PCG Q-1	8/4/05
PCG T-1 through T-5	2/19/04	PCG T-1 through T-5	8/4/05
PCG T-6	8/5/04	PCG T-6	8/5/04
I-1 through I-9	2/17/05	I-1 through I-9	8/4/05
OPI-1	2/19/04	OPI-1	8/4/05
OPI-2	8/5/04	OPI-2	8/5/04
OPI-5	2/19/04	OPI-5	8/4/05
OPI-6	8/5/04	OPI-6	8/4/05
OPI-7 through OPI-10	2/19/04	OPI-7 through OPI-10	8/4/05
OPI-11	8/5/04	OPI-11	8/4/05
OPI-12 and OPI-13	2/19/04	OPI-12 and OPI-13	8/4/05

Table of Contents

Chapter 1. Introduction

Section 1. General

Paragraph	Page
1-1-1. PURPOSE	1-1-1
1-1-2. DISTRIBUTION	1-1-1
1-1-3. CANCELLATION	1-1-1
1-1-4. EXPLANATION OF MAJOR CHANGES	1-1-1
1-1-5. EFFECTIVE DATE	1-1-1
1-1-6. RECOMMENDATIONS FOR PROCEDURAL CHANGES	1-1-1
1-1-7. PUBLICATION AND DELIVERY DATES	1-1-1
1-1-8. PROCEDURAL LETTERS OF AGREEMENT	1-1-2
1-1-9. CONSTRAINTS GOVERNING SUPPLEMENTS AND PROCEDURAL DEVIATIONS	1-1-2

Section 2. Terms of Reference

1-2-1. WORD MEANINGS	1-2-1
1-2-2. COURSE DEFINITIONS	1-2-2
1-2-3. NOTES	1-2-2
1-2-4. REFERENCES	1-2-3
1-2-5. ANNOTATIONS	1-2-3
1-2-6. ABBREVIATIONS	1-2-3

Chapter 2. General Control

Section 1. General

2-1-1. ATC SERVICE	2-1-1
2-1-2. DUTY PRIORITY	2-1-1
2-1-3. PROCEDURAL PREFERENCE	2-1-1
2-1-4. OPERATIONAL PRIORITY	2-1-2
2-1-5. EXPEDITIOUS COMPLIANCE	2-1-3
2-1-6. SAFETY ALERT	2-1-3
2-1-7. INFLIGHT EQUIPMENT MALFUNCTIONS	2-1-4
2-1-8. MINIMUM FUEL	2-1-4
2-1-9. REPORTING ESSENTIAL FLIGHT INFORMATION	2-1-5
2-1-10. NAVAID MALFUNCTIONS	2-1-5
2-1-11. USE OF MARSA	2-1-5
2-1-12. MILITARY PROCEDURES	2-1-6
2-1-13. FORMATION FLIGHTS	2-1-6
2-1-14. COORDINATE USE OF AIRSPACE	2-1-6
2-1-15. CONTROL TRANSFER	2-1-7
2-1-16. SURFACE AREAS	2-1-7
2-1-17. RADIO COMMUNICATIONS TRANSFER	2-1-7
2-1-18. OPERATIONAL REQUESTS	2-1-8
2-1-19. WAKE TURBULENCE	2-1-9
2-1-20. WAKE TURBULENCE CAUTIONARY ADVISORIES	2-1-9
2-1-21. TRAFFIC ADVISORIES	2-1-9
2-1-22. BIRD ACTIVITY INFORMATION	2-1-11

Paragraph	Page
2-1-23. TRANSFER OF POSITION RESPONSIBILITY	2-1-11
2-1-24. WHEELS DOWN CHECK	2-1-11
2-1-25. SUPERVISORY NOTIFICATION	2-1-11
2-1-26. PILOT DEVIATION NOTIFICATION	2-1-11
2-1-27. TCAS RESOLUTION ADVISORIES	2-1-11
2-1-28. RVSM OPERATIONS	2-1-12

Section 2. Flight Plans and Control Information

2-2-1. RECORDING INFORMATION	2-2-1
2-2-2. FORWARDING INFORMATION	2-2-1
2-2-3. FORWARDING VFR DATA	2-2-1
2-2-4. MILITARY DVFR DEPARTURES	2-2-1
2-2-5. IFR TO VFR FLIGHT PLAN CHANGE	2-2-1
2-2-6. IFR FLIGHT PROGRESS DATA	2-2-1
2-2-7. MANUAL INPUT OF COMPUTER-ASSIGNED BEACON CODES	2-2-2
2-2-8. ALTRV INFORMATION	2-2-2
2-2-9. COMPUTER MESSAGE VERIFICATION	2-2-2
2-2-10. TRANSMIT PROPOSED FLIGHT PLAN	2-2-3
2-2-11. FORWARDING AMENDED AND UTM DATA	2-2-3
2-2-12. AIRBORNE MILITARY FLIGHTS	2-2-4
2-2-13. FORWARDING FLIGHT PLAN DATA BETWEEN U.S. ARTCCs AND CANADIAN ACCs	2-2-4
2-2-14. TELETYPE FLIGHT DATA FORMAT- U.S. ARTCCs - CANADIAN ACCs	2-2-4
2-2-15. NORTH AMERICAN ROUTE PROGRAM (NRP) INFORMATION	2-2-5

Section 3. Flight Progress Strips

2-3-1. GENERAL	2-3-1
2-3-2. EN ROUTE DATA ENTRIES	2-3-3
2-3-3. TERMINAL DATA ENTRIES	2-3-5
2-3-4. AIRCRAFT IDENTITY	2-3-8
2-3-5. AIRCRAFT TYPE	2-3-9
2-3-6. USAF/USN UNDERGRADUATE PILOTS	2-3-9
2-3-7. AIRCRAFT EQUIPMENT SUFFIX	2-3-9
2-3-8. CLEARANCE STATUS	2-3-9
2-3-9. CONTROL SYMBOLOGY	2-3-9

Section 4. Radio and Interphone Communications

2-4-1. RADIO COMMUNICATIONS	2-4-1
2-4-2. MONITORING	2-4-1
2-4-3. PILOT ACKNOWLEDGMENT/READ BACK	2-4-1
2-4-4. AUTHORIZED INTERRUPTIONS	2-4-1
2-4-5. AUTHORIZED TRANSMISSIONS	2-4-1
2-4-6. FALSE OR DECEPTIVE COMMUNICATIONS	2-4-1
2-4-7. AUTHORIZED RELAYS	2-4-2
2-4-8. RADIO MESSAGE FORMAT	2-4-2
2-4-9. ABBREVIATED TRANSMISSIONS	2-4-2
2-4-10. INTERPHONE TRANSMISSION PRIORITIES	2-4-2

Paragraph	Page
2-4-11. PRIORITY INTERRUPTION	2-4-2
2-4-12. INTERPHONE MESSAGE FORMAT	2-4-3
2-4-13. INTERPHONE MESSAGE TERMINATION	2-4-4
2-4-14. WORDS AND PHRASES	2-4-4
2-4-15. EMPHASIS FOR CLARITY	2-4-4
2-4-16. ICAO PHONETICS	2-4-5
2-4-17. NUMBERS USAGE	2-4-5
2-4-18. NUMBER CLARIFICATION	2-4-8
2-4-19. FACILITY IDENTIFICATION	2-4-8
2-4-20. AIRCRAFT IDENTIFICATION	2-4-8
2-4-21. DESCRIPTION OF AIRCRAFT TYPES	2-4-11
2-4-22. AIRSPACE CLASSES	2-4-11

Section 5. Route and NAVAID Description

2-5-1. AIR TRAFFIC SERVICE (ATS) ROUTES	2-5-1
2-5-2. NAVAID TERMS	2-5-1
2-5-3. NAVAID FIXES	2-5-2

Section 6. Weather Information

2-6-1. FAMILIARIZATION	2-6-1
2-6-2. HAZARDOUS INFLIGHT WEATHER ADVISORY SERVICE (HIWAS) ..	2-6-1
2-6-3. PIREP INFORMATION	2-6-1
2-6-4. WEATHER AND CHAFF SERVICES	2-6-2
2-6-5. CALM WIND CONDITIONS	2-6-3
2-6-6. REPORTING WEATHER CONDITIONS	2-6-3
2-6-7. DISSEMINATING WEATHER INFORMATION	2-6-4

Section 7. Altimeter Settings

2-7-1. CURRENT SETTINGS	2-7-1
2-7-2. ALTIMETER SETTING ISSUANCE BELOW LOWEST USABLE FL	2-7-1

Section 8. Runway Visibility Reporting– Terminal

2-8-1. FURNISH RVR/RVV VALUES	2-8-1
2-8-2. ARRIVAL/DEPARTURE RUNWAY VISIBILITY	2-8-1
2-8-3. TERMINOLOGY	2-8-1

Section 9. Automatic Terminal Information Service Procedures

2-9-1. APPLICATION	2-9-1
2-9-2. OPERATING PROCEDURES	2-9-1
2-9-3. CONTENT	2-9-2

Section 10. Team Position Responsibilities

Paragraph	Page
2-10-1. EN ROUTE SECTOR TEAM POSITION RESPONSIBILITIES	2-10-1
2-10-2. TERMINAL RADAR/NONRADAR TEAM POSITION RESPONSIBILITIES	2-10-2
2-10-3. TOWER TEAM POSITION RESPONSIBILITIES	2-10-4

Chapter 3. Airport Traffic Control— Terminal

Section 1. General

3-1-1. PROVIDE SERVICE	3-1-1
3-1-2. PREVENTIVE CONTROL	3-1-1
3-1-3. USE OF ACTIVE RUNWAYS	3-1-1
3-1-4. COORDINATION BETWEEN LOCAL AND GROUND CONTROLLERS .	3-1-2
3-1-5. VEHICLES/EQUIPMENT/PERSONNEL ON RUNWAYS	3-1-2
3-1-6. TRAFFIC INFORMATION	3-1-2
3-1-7. POSITION DETERMINATION	3-1-2
3-1-8. LOW LEVEL WIND SHEAR/MICROBURST ADVISORIES	3-1-3
3-1-9. USE OF TOWER RADAR DISPLAYS	3-1-4
3-1-10. OBSERVED ABNORMALITIES	3-1-5
3-1-11. SURFACE AREA RESTRICTIONS	3-1-5
3-1-12. VISUALLY SCANNING RUNWAYS	3-1-5
3-1-13. ESTABLISHING TWO-WAY COMMUNICATIONS	3-1-5
3-1-14. GROUND OPERATIONS WHEN VOLCANIC ASH IS PRESENT	3-1-6

Section 2. Visual Signals

3-2-1. LIGHT SIGNALS	3-2-1
3-2-2. WARNING SIGNAL	3-2-1
3-2-3. RECEIVER-ONLY ACKNOWLEDGMENT	3-2-1

Section 3. Airport Conditions

3-3-1. LANDING AREA CONDITION	3-3-1
3-3-2. CLOSED/UNSAFE RUNWAY INFORMATION	3-3-1
3-3-3. TIMELY INFORMATION	3-3-1
3-3-4. BRAKING ACTION	3-3-2
3-3-5. BRAKING ACTION ADVISORIES	3-3-2
3-3-6. ARRESTING SYSTEM OPERATION	3-3-3
3-3-7. FAR FIELD MONITOR (FFM) REMOTE STATUS UNIT	3-3-4

Section 4. Airport Lighting

3-4-1. EMERGENCY LIGHTING	3-4-1
3-4-2. RUNWAY END IDENTIFIER LIGHTS	3-4-1
3-4-3. VISUAL APPROACH SLOPE INDICATORS (VASI)	3-4-1
3-4-4. PRECISION APPROACH PATH INDICATORS (PAPI)	3-4-1
3-4-5. APPROACH LIGHTS	3-4-2
3-4-6. ALS INTENSITY SETTINGS	3-4-2
3-4-7. SEQUENCED FLASHING LIGHTS (SFL)	3-4-2
3-4-8. MALSR/ODALS	3-4-2

Paragraph	Page
3-4-9. ALSF-2/SSALR	3-4-3
3-4-10. RUNWAY EDGE LIGHTS	3-4-3
3-4-11. HIGH INTENSITY RUNWAY, RUNWAY CENTERLINE, AND TOUCHDOWN ZONE LIGHTS	3-4-4
3-4-12. HIRL ASSOCIATED WITH MALSR	3-4-4
3-4-13. HIRL CHANGES AFFECTING RVR	3-4-4
3-4-14. MEDIUM INTENSITY RUNWAY LIGHTS	3-4-4
3-4-15. SIMULTANEOUS APPROACH AND RUNWAY EDGE LIGHT OPERATION	3-4-4
3-4-16. HIGH SPEED TURNOFF LIGHTS	3-4-4
3-4-17. TAXIWAY LIGHTS	3-4-5
3-4-18. OBSTRUCTION LIGHTS	3-4-5
3-4-19. ROTATING BEACON	3-4-5

Section 5. Runway Selection

3-5-1. SELECTION	3-5-1
3-5-2. STOL RUNWAYS	3-5-1
3-5-3. TAILWIND COMPONENTS	3-5-1

Section 6. Airport Surface Detection Procedures

3-6-1. EQUIPMENT USAGE	3-6-1
3-6-2. INFORMATION USAGE	3-6-1
3-6-3. IDENTIFICATION	3-6-1
3-6-4. AMASS ALERT RESPONSES	3-6-1

Section 7. Taxi and Ground Movement Procedures

3-7-1. GROUND TRAFFIC MOVEMENT	3-7-1
3-7-2. TAXI AND GROUND MOVEMENT OPERATIONS	3-7-1
3-7-3. GROUND OPERATIONS	3-7-3
3-7-4. RUNWAY PROXIMITY	3-7-4
3-7-5. PRECISION APPROACH CRITICAL AREA	3-7-4

Section 8. Spacing and Sequencing

3-8-1. SEQUENCE/SPACING APPLICATION	3-8-1
3-8-2. TOUCH-AND-GO OR STOP-AND-GO OR LOW APPROACH	3-8-1
3-8-3. SIMULTANEOUS SAME DIRECTION OPERATION	3-8-1
3-8-4. SIMULTANEOUS OPPOSITE DIRECTION OPERATION	3-8-2

Section 9. Departure Procedures and Separation

3-9-1. DEPARTURE INFORMATION	3-9-1
3-9-2. DEPARTURE DELAY INFORMATION	3-9-1
3-9-3. DEPARTURE CONTROL INSTRUCTIONS	3-9-1
3-9-4. TAXI INTO POSITION AND HOLD (TIPH)	3-9-2
3-9-5. ANTICIPATING SEPARATION	3-9-3
3-9-6. SAME RUNWAY SEPARATION	3-9-3
3-9-7. WAKE TURBULENCE SEPARATION FOR INTERSECTION DEPARTURES	3-9-5

Paragraph	Page
3-9-8. INTERSECTING RUNWAY SEPARATION	3-9-6
3-9-9. TAKEOFF CLEARANCE	3-9-7
3-9-10. CANCELLATION OF TAKEOFF CLEARANCE	3-9-8

Section 10. Arrival Procedures and Separation

3-10-1. LANDING INFORMATION	3-10-1
3-10-2. FORWARDING APPROACH INFORMATION BY NONAPPROACH CONTROL FACILITIES	3-10-1
3-10-3. SAME RUNWAY SEPARATION	3-10-2
3-10-4. INTERSECTING RUNWAY SEPARATION	3-10-3
3-10-5. LANDING CLEARANCE	3-10-6
3-10-6. ANTICIPATING SEPARATION	3-10-6
3-10-7. LANDING CLEARANCE WITHOUT VISUAL OBSERVATION	3-10-7
3-10-8. WITHHOLDING LANDING CLEARANCE	3-10-7
3-10-9. RUNWAY EXITING	3-10-7
3-10-10. ALTITUDE RESTRICTED LOW APPROACH	3-10-8
3-10-11. CLOSED TRAFFIC	3-10-8
3-10-12. OVERHEAD MANEUVER	3-10-8
3-10-13. SIMULATED FLAMEOUT (SFO) APPROACHES/EMERGENCY LANDING PATTERN (ELP) OPERATIONS/PRACTICE PRECAUTIONARY APPROACHES	3-10-9

Section 11. Helicopter Operations

3-11-1. TAXI AND GROUND MOVEMENT OPERATION	3-11-1
3-11-2. HELICOPTER TAKEOFF CLEARANCE	3-11-1
3-11-3. HELICOPTER DEPARTURE SEPARATION	3-11-2
3-11-4. HELICOPTER ARRIVAL SEPARATION	3-11-3
3-11-5. SIMULTANEOUS LANDINGS OR TAKEOFFS	3-11-3
3-11-6. HELICOPTER LANDING CLEARANCE	3-11-4

Section 12. Sea Lane Operations

3-12-1. APPLICATION	3-12-1
3-12-2. DEPARTURE SEPARATION	3-12-1
3-12-3. ARRIVAL SEPARATION	3-12-1

Chapter 4. IFR

Section 1. NAVAID Use Limitations

4-1-1. ALTITUDE AND DISTANCE LIMITATIONS	4-1-1
4-1-2. EXCEPTIONS	4-1-2
4-1-3. CROSSING ALTITUDE	4-1-2
4-1-4. VFR-ON-TOP	4-1-2
4-1-5. FIX USE	4-1-2

Section 2. Clearances

Paragraph	Page
4-2-1. CLEARANCE ITEMS	4-2-1
4-2-2. CLEARANCE PREFIX	4-2-1
4-2-3. DELIVERY INSTRUCTIONS	4-2-1
4-2-4. CLEARANCE RELAY	4-2-1
4-2-5. ROUTE OR ALTITUDE AMENDMENTS	4-2-1
4-2-6. THROUGH CLEARANCES	4-2-2
4-2-7. ALTRV CLEARANCE	4-2-2
4-2-8. IFR-VFR AND VFR-IFR FLIGHTS	4-2-3
4-2-9. CLEARANCE ITEMS	4-2-3

Section 3. Departure Procedures

4-3-1. DEPARTURE TERMINOLOGY	4-3-1
4-3-2. DEPARTURE CLEARANCES	4-3-1
4-3-3. ABBREVIATED DEPARTURE CLEARANCE	4-3-3
4-3-4. DEPARTURE RESTRICTIONS, CLEARANCE VOID TIMES, HOLD FOR RELEASE, AND RELEASE TIMES	4-3-5
4-3-5. GROUND STOP	4-3-6
4-3-6. DELAY SEQUENCING	4-3-6
4-3-7. FORWARD DEPARTURE DELAY INFORMATION	4-3-6
4-3-8. COORDINATION WITH RECEIVING FACILITY	4-3-6
4-3-9. VFR RELEASE OF IFR DEPARTURE	4-3-7
4-3-10. FORWARDING DEPARTURE TIMES	4-3-7

Section 4. Route Assignment

4-4-1. ROUTE USE	4-4-1
4-4-2. ROUTE STRUCTURE TRANSITIONS	4-4-2
4-4-3. DEGREE-DISTANCE ROUTE DEFINITION FOR MILITARY OPERATIONS	4-4-2
4-4-4. ALTERNATIVE ROUTES	4-4-3
4-4-5. CLASS G AIRSPACE	4-4-3
4-4-6. DIRECT CLEARANCES	4-4-3

Section 5. Altitude Assignment and Verification

4-5-1. VERTICAL SEPARATION MINIMA	4-5-1
4-5-2. FLIGHT DIRECTION	4-5-1
4-5-3. EXCEPTIONS	4-5-2
4-5-4. LOWEST USABLE FLIGHT LEVEL	4-5-2
4-5-5. ADJUSTED MINIMUM FLIGHT LEVEL	4-5-2
4-5-6. MINIMUM EN ROUTE ALTITUDES	4-5-3
4-5-7. ALTITUDE INFORMATION	4-5-3
4-5-8. ANTICIPATED ALTITUDE CHANGES	4-5-7
4-5-9. ALTITUDE CONFIRMATION- NONRADAR	4-5-7

Section 6. Holding Aircraft

Paragraph	Page
4-6-1. CLEARANCE TO HOLDING FIX	4-6-1
4-6-2. CLEARANCE BEYOND FIX	4-6-2
4-6-3. DELAYS	4-6-2
4-6-4. HOLDING INSTRUCTIONS	4-6-3
4-6-5. VISUAL HOLDING POINTS	4-6-3
4-6-6. HOLDING FLIGHT PATH DEVIATION	4-6-3
4-6-7. UNMONITORED NAVAIDS	4-6-3
4-6-8. ILS PROTECTION/CRITICAL AREAS	4-6-3

Section 7. Arrival Procedures

4-7-1. CLEARANCE INFORMATION	4-7-1
4-7-2. ADVANCE DESCENT CLEARANCE	4-7-1
4-7-3. SINGLE FREQUENCY APPROACHES (SFA)	4-7-1
4-7-4. RADIO FREQUENCY AND RADAR BEACON CHANGES FOR MILITARY AIRCRAFT	4-7-2
4-7-5. MILITARY TURBOJET EN ROUTE DESCENT	4-7-2
4-7-6. ARRIVAL INFORMATION	4-7-3
4-7-7. WEATHER INFORMATION	4-7-3
4-7-8. BELOW MINIMA REPORT BY PILOT	4-7-4
4-7-9. TRANSFER OF JURISDICTION	4-7-4
4-7-10. APPROACH INFORMATION	4-7-4
4-7-11. ARRIVAL INFORMATION BY APPROACH CONTROL FACILITIES ...	4-7-5
4-7-12. AIRPORT CONDITIONS	4-7-5
4-7-13. SWITCHING ILS/MLS RUNWAYS	4-7-6

Section 8. Approach Clearance Procedures

4-8-1. APPROACH CLEARANCE	4-8-1
4-8-2. CLEARANCE LIMIT	4-8-5
4-8-3. RELAYED APPROACH CLEARANCE	4-8-5
4-8-4. ALTITUDE ASSIGNMENT FOR MILITARY HIGH ALTITUDE INSTRUMENT APPROACHES	4-8-5
4-8-5. SPECIFYING ALTITUDE	4-8-5
4-8-6. CIRCLING APPROACH	4-8-5
4-8-7. SIDE-STEP MANEUVER	4-8-5
4-8-8. COMMUNICATIONS RELEASE	4-8-6
4-8-9. MISSED APPROACH	4-8-6
4-8-10. APPROACH INFORMATION	4-8-6
4-8-11. PRACTICE APPROACHES	4-8-6
4-8-12. LOW APPROACH AND TOUCH-AND-GO	4-8-7

Chapter 5. Radar

Section 1. General

5-1-1. PRESENTATION AND EQUIPMENT PERFORMANCE	5-1-1
5-1-2. ALIGNMENT ACCURACY CHECK	5-1-1
5-1-3. RADAR USE	5-1-1
5-1-4. BEACON RANGE ACCURACY	5-1-2

Paragraph	Page
5-1-5. ELECTRONIC ATTACK (EA) ACTIVITY	5-1-2
5-1-6. SERVICE LIMITATIONS	5-1-3
5-1-7. ELECTRONIC CURSOR	5-1-3
5-1-8. MERGING TARGET PROCEDURES	5-1-3
5-1-9. HOLDING PATTERN SURVEILLANCE	5-1-4
5-1-10. DEVIATION ADVISORIES	5-1-4
5-1-11. RADAR FIX POSTING	5-1-4
5-1-12. POSITION REPORTING	5-1-4
5-1-13. RADAR SERVICE TERMINATION	5-1-4

Section 2. Beacon Systems

5-2-1. ASSIGNMENT CRITERIA	5-2-1
5-2-2. DISCRETE ENVIRONMENT	5-2-1
5-2-3. NONDISCRETE ENVIRONMENT	5-2-1
5-2-4. MIXED ENVIRONMENT	5-2-1
5-2-5. RADAR BEACON CODE CHANGES	5-2-2
5-2-6. FUNCTION CODE ASSIGNMENTS	5-2-2
5-2-7. EMERGENCY CODE ASSIGNMENT	5-2-3
5-2-8. RADIO FAILURE	5-2-3
5-2-9. VFR CODE ASSIGNMENTS	5-2-3
5-2-10. BEACON CODE FOR PRESSURE SUIT FLIGHTS AND FLIGHTS ABOVE FL 600	5-2-4
5-2-11. AIR DEFENSE EXERCISE BEACON CODE ASSIGNMENT	5-2-4
5-2-12. STANDBY OR LOW SENSITIVITY OPERATION	5-2-5
5-2-13. CODE MONITOR	5-2-5
5-2-14. FAILURE TO DISPLAY ASSIGNED BEACON CODE OR INOPERATIVE/MALFUNCTIONING TRANSPONDER	5-2-5
5-2-15. INOPERATIVE OR MALFUNCTIONING INTERROGATOR	5-2-6
5-2-16. FAILED TRANSPONDER IN CLASS A AIRSPACE	5-2-6
5-2-17. VALIDATION OF MODE C READOUT	5-2-6
5-2-18. ALTITUDE CONFIRMATION- MODE C	5-2-7
5-2-19. ALTITUDE CONFIRMATION- NON-MODE C	5-2-7
5-2-20. AUTOMATIC ALTITUDE REPORTING	5-2-7
5-2-21. INFLIGHT DEVIATIONS FROM TRANSPONDER/MODE C REQUIREMENTS BETWEEN 10,000 FEET AND 18,000 FEET	5-2-8
5-2-22. BEACON TERMINATION	5-2-8
5-2-23. ALTITUDE FILTERS	5-2-8

Section 3. Radar Identification

5-3-1. APPLICATION	5-3-1
5-3-2. PRIMARY RADAR IDENTIFICATION METHODS	5-3-1
5-3-3. BEACON IDENTIFICATION METHODS	5-3-1
5-3-4. TERMINAL AUTOMATION SYSTEMS IDENTIFICATION METHODS ..	5-3-2
5-3-5. QUESTIONABLE IDENTIFICATION	5-3-2
5-3-6. POSITION INFORMATION	5-3-2
5-3-7. IDENTIFICATION STATUS	5-3-2
5-3-8. TARGET MARKERS	5-3-3
5-3-9. TARGET MARKERS	5-3-3

Section 4. Transfer of Radar Identification

Paragraph	Page
5-4-1. APPLICATION	5-4-1
5-4-2. TERMS	5-4-1
5-4-3. METHODS	5-4-1
5-4-4. TRAFFIC	5-4-2
5-4-5. TRANSFERRING CONTROLLER HANDOFF	5-4-2
5-4-6. RECEIVING CONTROLLER HANDOFF	5-4-3
5-4-7. POINT OUT	5-4-4
5-4-8. AUTOMATED INFORMATION TRANSFER (AIT)	5-4-5
5-4-9. INTERFACILITY AUTOMATED INFORMATION TRANSFER	5-4-5
5-4-10. PREARRANGED COORDINATION	5-4-5
5-4-11. EN ROUTE FOURTH LINE DATA BLOCK USAGE	5-4-5

Section 5. Radar Separation

5-5-1. APPLICATION	5-5-1
5-5-2. TARGET SEPARATION	5-5-1
5-5-3. TARGET RESOLUTION	5-5-1
5-5-4. MINIMA	5-5-2
5-5-5. VERTICAL APPLICATION	5-5-3
5-5-6. EXCEPTIONS	5-5-3
5-5-7. PASSING OR DIVERGING	5-5-4
5-5-8. ADDITIONAL SEPARATION FOR FORMATION FLIGHTS	5-5-4
5-5-9. SEPARATION FROM OBSTRUCTIONS	5-5-5
5-5-10. ADJACENT AIRSPACE	5-5-5
5-5-11. EDGE OF SCOPE	5-5-5
5-5-12. BEACON TARGET DISPLACEMENT	5-5-6
5-5-13. GPA 102/103 CORRECTION FACTOR	5-5-6

Section 6. Vectoring

5-6-1. APPLICATION	5-6-1
5-6-2. METHODS	5-6-1
5-6-3. VECTORS BELOW MINIMUM ALTITUDE	5-6-2

Section 7. Speed Adjustment

5-7-1. APPLICATION	5-7-1
5-7-2. METHODS	5-7-2
5-7-3. MINIMA	5-7-3
5-7-4. TERMINATION	5-7-3

Section 8. Radar Departures

5-8-1. PROCEDURES	5-8-1
5-8-2. INITIAL HEADING	5-8-1
5-8-3. SUCCESSIVE OR SIMULTANEOUS DEPARTURES	5-8-1
5-8-4. DEPARTURE AND ARRIVAL	5-8-3
5-8-5. DEPARTURES AND ARRIVALS ON PARALLEL OR NONINTERSECTING DIVERGING RUNWAYS	5-8-3

Section 9. Radar Arrivals

Paragraph	Page
5-9-1. VECTORS TO FINAL APPROACH COURSE	5-9-1
5-9-2. FINAL APPROACH COURSE INTERCEPTION	5-9-1
5-9-3. VECTORS ACROSS FINAL APPROACH COURSE	5-9-2
5-9-4. ARRIVAL INSTRUCTIONS	5-9-2
5-9-5. APPROACH SEPARATION RESPONSIBILITY	5-9-5
5-9-6. PARALLEL DEPENDENT ILS/MLS APPROACHES	5-9-5
5-9-7. SIMULTANEOUS INDEPENDENT ILS/MLS APPROACHES— DUAL & TRIPLE	5-9-8
5-9-8. SIMULTANEOUS INDEPENDENT DUAL ILS/MLS APPROACHES— HIGH UPDATE RADAR	5-9-9

Section 10. Radar Approaches— Terminal

5-10-1. APPLICATION	5-10-1
5-10-2. APPROACH INFORMATION	5-10-1
5-10-3. NO-GYRO APPROACH	5-10-2
5-10-4. LOST COMMUNICATIONS	5-10-2
5-10-5. RADAR CONTACT LOST	5-10-3
5-10-6. LANDING CHECK	5-10-3
5-10-7. POSITION INFORMATION	5-10-3
5-10-8. FINAL CONTROLLER CHANGEOVER	5-10-3
5-10-9. COMMUNICATIONS CHECK	5-10-4
5-10-10. TRANSMISSION ACKNOWLEDGMENT	5-10-4
5-10-11. MISSED APPROACH	5-10-4
5-10-12. LOW APPROACH AND TOUCH-AND-GO	5-10-4
5-10-13. TOWER CLEARANCE	5-10-4
5-10-14. FINAL APPROACH ABNORMALITIES	5-10-5
5-10-15. MILITARY SINGLE FREQUENCY APPROACHES	5-10-5

Section 11. Surveillance Approaches— Terminal

5-11-1. ALTITUDE INFORMATION	5-11-1
5-11-2. VISUAL REFERENCE REPORT	5-11-1
5-11-3. DESCENT NOTIFICATION	5-11-1
5-11-4. DESCENT INSTRUCTIONS	5-11-1
5-11-5. FINAL APPROACH GUIDANCE	5-11-2
5-11-6. APPROACH GUIDANCE TERMINATION	5-11-2

Section 12. PAR Approaches— Terminal

5-12-1. GLIDEPATH NOTIFICATION	5-12-1
5-12-2. DECISION HEIGHT (DH) NOTIFICATION	5-12-1
5-12-3. DESCENT INSTRUCTION	5-12-1
5-12-4. GLIDEPATH AND COURSE INFORMATION	5-12-1
5-12-5. DISTANCE FROM TOUCHDOWN	5-12-1
5-12-6. DECISION HEIGHT	5-12-1
5-12-7. POSITION ADVISORIES	5-12-1
5-12-8. APPROACH GUIDANCE TERMINATION	5-12-2

Paragraph	Page
5-12-9. COMMUNICATION TRANSFER	5-12-2
5-12-10. ELEVATION FAILURE	5-12-2
5-12-11. SURVEILLANCE UNUSABLE	5-12-3

**Section 13. Use of PAR for
Approach Monitoring— Terminal**

5-13-1. MONITOR ON PAR EQUIPMENT	5-13-1
5-13-2. MONITOR AVAILABILITY	5-13-1
5-13-3. MONITOR INFORMATION	5-13-1

Section 14. Automation— En Route

5-14-1. CONFLICT ALERT (CA) AND MODE C INTRUDER (MCI) ALERT	5-14-1
5-14-2. EN ROUTE MINIMUM SAFE ALTITUDE WARNING (E-MSAW)	5-14-1
5-14-3. COMPUTER ENTRY OF ASSIGNED ALTITUDE	5-14-1
5-14-4. ENTRY OF REPORTED ALTITUDE	5-14-2
5-14-5. SELECTED ALTITUDE LIMITS	5-14-2
5-14-6. SECTOR ELIGIBILITY	5-14-2
5-14-7. COAST TRACKS	5-14-2
5-14-8. CONTROLLER INITIATED COAST TRACKS	5-14-2

**Section 15. Automated Radar Terminal
Systems (ARTS)— Terminal**

5-15-1. APPLICATION	5-15-1
5-15-2. RESPONSIBILITY	5-15-1
5-15-3. FUNCTIONAL USE	5-15-1
5-15-4. SYSTEM REQUIREMENTS	5-15-1
5-15-5. INFORMATION DISPLAYED	5-15-1
5-15-6. CA/MCI	5-15-2
5-15-7. INHIBITING MINIMUM SAFE ALTITUDE WARNING (MSAW)	5-15-2
5-15-8. TRACK SUSPEND FUNCTION	5-15-2

Section 16. TPX-42— Terminal

5-16-1. APPLICATION	5-16-1
5-16-2. RESPONSIBILITY	5-16-1
5-16-3. FUNCTIONAL USE	5-16-1
5-16-4. SYSTEM REQUIREMENTS	5-16-1
5-16-5. INFORMATION DISPLAYED	5-16-1
5-16-6. INHIBITING LOW ALTITUDE ALERT SYSTEM (LAAS)	5-16-1

**Chapter 6. Nonradar
Section 1. General**

6-1-1. DISTANCE	6-1-1
6-1-2. NONRECEIPT OF POSITION REPORT	6-1-1
6-1-3. DUPLICATE POSITION REPORTS	6-1-1
6-1-4. ADJACENT AIRPORT OPERATION	6-1-1
6-1-5. ARRIVAL MINIMA	6-1-1

Section 2. Initial Separation of Successive Departing Aircraft

Paragraph	Page
6-2-1. MINIMA ON DIVERGING COURSES	6-2-1
6-2-2. MINIMA ON SAME COURSE	6-2-3

Section 3. Initial Separation of Departing and Arriving Aircraft

6-3-1. SEPARATION MINIMA	6-3-1
--------------------------------	-------

Section 4. Longitudinal Separation

6-4-1. APPLICATION	6-4-1
6-4-2. MINIMA ON SAME, CONVERGING, OR CROSSING COURSES	6-4-1
6-4-3. MINIMA ON OPPOSITE COURSES	6-4-5
6-4-4. SEPARATION BY PILOTS	6-4-6
6-4-5. RNAV AIRCRAFT ALONG VOR AIRWAYS/ROUTES	6-4-6

Section 5. Lateral Separation

6-5-1. SEPARATION METHODS	6-5-1
6-5-2. MINIMA ON DIVERGING RADIALS	6-5-1
6-5-3. DME ARC MINIMA	6-5-2
6-5-4. MINIMA ALONG OTHER THAN ESTABLISHED AIRWAYS OR ROUTES	6-5-2
6-5-5. RNAV MINIMA- DIVERGING/CROSSING COURSES	6-5-4

Section 6. Vertical Separation

6-6-1. APPLICATION	6-6-1
6-6-2. EXCEPTIONS	6-6-1
6-6-3. SEPARATION BY PILOTS	6-6-1

Section 7. Timed Approaches

6-7-1. APPLICATION	6-7-1
6-7-2. APPROACH SEQUENCE	6-7-1
6-7-3. SEQUENCE INTERRUPTION	6-7-2
6-7-4. LEVEL FLIGHT RESTRICTION	6-7-2
6-7-5. INTERVAL MINIMA	6-7-2
6-7-6. TIME CHECK	6-7-2
6-7-7. MISSED APPROACHES	6-7-2

Chapter 7. Visual

Section 1. General

Paragraph	Page
7-1-1. CLASS A AIRSPACE RESTRICTIONS	7-1-1
7-1-2. VFR CONDITIONS	7-1-1
7-1-3. APPROACH CONTROL SERVICE FOR VFR ARRIVING AIRCRAFT ...	7-1-1
7-1-4. VISUAL HOLDING OF VFR AIRCRAFT	7-1-1

Section 2. Visual Separation

7-2-1. VISUAL SEPARATION	7-2-1
--------------------------------	-------

Section 3. VFR-on-top

7-3-1. VFR-ON-TOP	7-3-1
7-3-2. ALTITUDE FOR DIRECTION OF FLIGHT	7-3-2

Section 4. Approaches

7-4-1. VISUAL APPROACH	7-4-1
7-4-2. VECTORS FOR VISUAL APPROACH	7-4-1
7-4-3. CLEARANCE FOR VISUAL APPROACH	7-4-1
7-4-4. APPROACHES TO MULTIPLE RUNWAYS	7-4-2
7-4-5. CHARTED VISUAL FLIGHT PROCEDURES (CVFP), USA/USN NOT APPLICABLE	7-4-3
7-4-6. CONTACT APPROACH	7-4-3

Section 5. Special VFR (SVFR)

7-5-1. AUTHORIZATION	7-5-1
7-5-2. PRIORITY	7-5-1
7-5-3. SEPARATION	7-5-2
7-5-4. ALTITUDE ASSIGNMENT	7-5-2
7-5-5. LOCAL OPERATIONS	7-5-2
7-5-6. CLIMB TO VFR	7-5-3
7-5-7. GROUND VISIBILITY BELOW ONE MILE	7-5-3
7-5-8. FLIGHT VISIBILITY BELOW ONE MILE	7-5-3

Section 6. Basic Radar Service to VFR Aircraft— Terminal

7-6-1. APPLICATION	7-6-1
7-6-2. SERVICE AVAILABILITY	7-6-1
7-6-3. INITIAL CONTACT	7-6-1
7-6-4. IDENTIFICATION	7-6-1
7-6-5. HOLDING	7-6-1
7-6-6. APPROACH SEQUENCE	7-6-1
7-6-7. SEQUENCING	7-6-1
7-6-8. CONTROL TRANSFER	7-6-2
7-6-9. ABANDONED APPROACH	7-6-2

Paragraph	Page
7-6-10. VFR DEPARTURE INFORMATION	7-6-2
7-6-11. TERMINATION OF SERVICE	7-6-2
7-6-12. SERVICE PROVIDED WHEN TOWER IS INOPERATIVE	7-6-3

**Section 7. Terminal Radar Service
Area (TRSA) – Terminal**

7-7-1. APPLICATION	7-7-1
7-7-2. ISSUANCE OF EFC	7-7-1
7-7-3. SEPARATION	7-7-1
7-7-4. HELICOPTER TRAFFIC	7-7-1
7-7-5. ALTITUDE ASSIGNMENTS	7-7-1
7-7-6. APPROACH INTERVAL	7-7-1
7-7-7. TRSA DEPARTURE INFORMATION	7-7-1

Section 8. Class C Service– Terminal

7-8-1. APPLICATION	7-8-1
7-8-2. CLASS C SERVICES	7-8-1
7-8-3. SEPARATION	7-8-1
7-8-4. ESTABLISHING TWO-WAY COMMUNICATIONS	7-8-1
7-8-5. ALTITUDE ASSIGNMENTS	7-8-1
7-8-6. EXCEPTIONS	7-8-2
7-8-7. ADJACENT AIRPORT OPERATIONS	7-8-2
7-8-8. TERMINATION OF SERVICE	7-8-2

Section 9. Class B Service Area– Terminal

7-9-1. APPLICATION	7-9-1
7-9-2. VFR AIRCRAFT IN CLASS B AIRSPACE	7-9-1
7-9-3. METHODS	7-9-1
7-9-4. SEPARATION	7-9-2
7-9-5. TRAFFIC ADVISORIES	7-9-2
7-9-6. HELICOPTER TRAFFIC	7-9-2
7-9-7. ALTITUDE ASSIGNMENTS	7-9-2
7-9-8. APPROACH INTERVAL	7-9-2

Chapter 8. Offshore/Oceanic Procedures

Section 1. General

8-1-1. ATC SERVICE	8-1-1
8-1-2. OPERATIONS IN OFFSHORE AIRSPACE AREAS	8-1-1
8-1-3. VFR FLIGHT PLANS	8-1-1
8-1-4. TYPES OF SEPARATION	8-1-1
8-1-5. ALTIMETER SETTING	8-1-1
8-1-6. RECEIPT OF POSITION REPORTS	8-1-1
8-1-7. OCEANIC NAVIGATIONAL ERROR REPORTING (ONER) PROCEDURES	8-1-1
8-1-8. USE OF CONTROL ESTIMATES	8-1-1

Section 2. Coordination

Paragraph	Page
8-2-1. GENERAL	8-2-1
8-2-2. TRANSFER OF CONTROL AND COMMUNICATIONS	8-2-1
8-2-3. AIR TRAFFIC SERVICES INTERFACILITY DATA COMMUNICATIONS (AIDC)	8-2-1

Section 3. Longitudinal Separation

8-3-1. APPLICATION	8-3-1
8-3-2. SEPARATION METHODS	8-3-1
8-3-3. MACH NUMBER TECHNIQUE	8-3-2

Section 4. Lateral Separation

8-4-1. APPLICATION	8-4-1
8-4-2. SEPARATION METHODS	8-4-1
8-4-3. REDUCTION OF ROUTE PROTECTED AIRSPACE	8-4-3
8-4-4. TRACK SEPARATION	8-4-4

Section 5. Offshore/Oceanic Transition Procedures

8-5-1. ALTITUDE/FLIGHT LEVEL TRANSITION	8-5-1
8-5-2. COURSE DIVERGENCE	8-5-1
8-5-3. OPPOSITE DIRECTION	8-5-1
8-5-4. SAME DIRECTION	8-5-2

Section 6. Separation from Airspace Reservations

8-6-1. TEMPORARY STATIONARY AIRSPACE RESERVATIONS	8-6-1
8-6-2. REFUSAL OF AVOIDANCE CLEARANCE	8-6-1
8-6-3. TEMPORARY MOVING AIRSPACE RESERVATIONS	8-6-1

Section 7. North Atlantic ICAO Region

8-7-1. APPLICATION	8-7-1
8-7-2. VERTICAL SEPARATION	8-7-1
8-7-3. LONGITUDINAL SEPARATION	8-7-1
8-7-4. LATERAL SEPARATION	8-7-1
8-7-5. PROCEDURES FOR WEATHER DEVIATIONS IN NORTH ATLANTIC (NAT) AIRSPACE	8-7-2

Section 8. Caribbean ICAO Region

8-8-1. APPLICATION	8-8-1
8-8-2. VERTICAL SEPARATION	8-8-1
8-8-3. LONGITUDINAL SEPARATION	8-8-1
8-8-4. LATERAL SEPARATION	8-8-2
8-8-5. VFR CLIMB AND DESCENT	8-8-2

Section 9. Pacific ICAO Region

Paragraph	Page
8-9-1. APPLICATION	8-9-1
8-9-2. VERTICAL SEPARATION	8-9-1
8-9-3. LONGITUDINAL SEPARATION	8-9-1
8-9-4. LATERAL SEPARATION	8-9-2
8-9-5. COMPOSITE SEPARATION MINIMA	8-9-2
8-9-6. COMPOSITE SEPARATION ALTITUDE ASSIGNMENT	8-9-2
8-9-7. COMPOSITE SEPARATION APPLICATION	8-9-3
8-9-8. PROCEDURES FOR WEATHER DEVIATIONS AND OTHER CONTINGENCIES IN OCEANIC CONTROLLED AIRSPACE	8-9-3

**Section 10. North American
ICAO Region— Arctic CTA**

8-10-1. APPLICATION	8-10-1
8-10-2. VERTICAL SEPARATION	8-10-1
8-10-3. LONGITUDINAL SEPARATION	8-10-1
8-10-4. LATERAL SEPARATION	8-10-1

**Chapter 9. Special Flights
Section 1. General**

9-1-1. GENERAL	9-1-1
9-1-2. SPECIAL HANDLING	9-1-1
9-1-3. FLIGHT CHECK AIRCRAFT	9-1-1

Section 2. Special Interest Flights

9-2-1. GENERAL	9-2-1
9-2-2. APPLICATION	9-2-1
9-2-3. EMERGENCY OR UNSCHEDULED LANDINGS	9-2-2

Section 3. Special Operations

9-3-1. AIRCRAFT CARRYING DANGEROUS MATERIALS	9-3-1
9-3-2. CELESTIAL NAVIGATION TRAINING	9-3-1
9-3-3. DEPARTMENT OF ENERGY (DOE) SPECIAL FLIGHTS	9-3-1
9-3-4. EXPERIMENTAL AIRCRAFT OPERATIONS	9-3-2
9-3-5. FAA RESEARCH AND DEVELOPMENT FLIGHTS	9-3-2
9-3-6. FLYNET	9-3-2
9-3-7. IFR MILITARY TRAINING ROUTES	9-3-2
9-3-8. INTERCEPTOR OPERATIONS	9-3-4
9-3-9. SPECIAL INTEREST SITES	9-3-4
9-3-10. LAND-BASED AIR DEFENSE IDENTIFICATION ZONE (ADIZ) ATC PROCEDURES	9-3-4
9-3-11. LAW ENFORCEMENT OPERATIONS BY CIVIL AND MILITARY ORGANIZATIONS	9-3-4
9-3-12. MILITARY AERIAL REFUELING	9-3-5
9-3-13. MILITARY OPERATIONS ABOVE FL 600	9-3-7
9-3-14. MILITARY SPECIAL USE FREQUENCIES	9-3-7

Paragraph	Page
9-3-15. AVOIDANCE OF AREAS OF NUCLEAR RADIATION	9-3-8
9-3-16. SAMP	9-3-8
9-3-17. AWACS/NORAD SPECIAL FLIGHTS	9-3-8
9-3-18. WEATHER RECONNAISSANCE FLIGHTS	9-3-8
9-3-19. EVASIVE ACTION MANEUVER	9-3-9
9-3-20. NONSTANDARD FORMATION/CELL OPERATIONS	9-3-9
9-3-21. OPEN SKIES TREATY AIRCRAFT	9-3-9

Section 4. Special Use and ATC Assigned Airspace

9-4-1. APPLICATION	9-4-1
9-4-2. SEPARATION MINIMA	9-4-1
9-4-3. VFR-ON-TOP	9-4-1
9-4-4. TRANSITING ACTIVE SUA/ATCAA	9-4-2

Section 5. Fuel Dumping

9-5-1. INFORMATION REQUIREMENTS	9-5-1
9-5-2. ROUTING	9-5-1
9-5-3. ALTITUDE ASSIGNMENT	9-5-1
9-5-4. SEPARATION MINIMA	9-5-1
9-5-5. INFORMATION DISSEMINATION	9-5-1

Section 6. Jettisoning of External Stores

9-6-1. JETTISONING OF EXTERNAL STORES	9-6-1
---	-------

Section 7. Unmanned Free Balloons

9-7-1. APPLICATION	9-7-1
9-7-2. DERELICT BALLOONS	9-7-2

Section 8. Parachute Operations

9-8-1. COORDINATION	9-8-1
9-8-2. CLASS A, CLASS B, AND CLASS C AIRSPACE	9-8-1
9-8-3. CLASS D AIRSPACE	9-8-1
9-8-4. OTHER CONTROL AIRSPACE	9-8-1

Section 9. Unidentified Flying Object (UFO) Reports

9-9-1. GENERAL	9-9-1
----------------------	-------

Chapter 10. Emergencies

Section 1. General

10-1-1. EMERGENCY DETERMINATIONS	10-1-1
10-1-2. OBTAINING INFORMATION	10-1-1
10-1-3. PROVIDING ASSISTANCE	10-1-1
10-1-4. RESPONSIBILITY	10-1-1

Paragraph	Page
10-1-5. COORDINATION	10-1-2
10-1-6. AIRPORT GROUND EMERGENCY	10-1-2
10-1-7. INFLIGHT EMERGENCIES INVOLVING MILITARY FIGHTER-TYPE AIRCRAFT	10-1-2

Section 2. Emergency Assistance

10-2-1. INFORMATION REQUIREMENTS	10-2-1
10-2-2. FREQUENCY CHANGES	10-2-1
10-2-3. AIRCRAFT ORIENTATION	10-2-1
10-2-4. ALTITUDE CHANGE FOR IMPROVED RECEPTION	10-2-1
10-2-5. EMERGENCY SITUATIONS	10-2-1
10-2-6. HIJACKED AIRCRAFT	10-2-2
10-2-7. VFR AIRCRAFT IN WEATHER DIFFICULTY	10-2-2
10-2-8. RADAR ASSISTANCE TO VFR AIRCRAFT IN WEATHER DIFFICULTY	10-2-3
10-2-9. RADAR ASSISTANCE TECHNIQUES	10-2-3
10-2-10. EMERGENCY LOCATOR TRANSMITTER (ELT) SIGNALS	10-2-3
10-2-11. AIRCRAFT BOMB THREATS	10-2-4
10-2-12. EXPLOSIVE DETECTION K-9 TEAMS	10-2-5
10-2-13. MANPADS ALERT	10-2-6
10-2-14. EMERGENCY AIRPORT RECOMMENDATION	10-2-6
10-2-15. GUIDANCE TO EMERGENCY AIRPORT	10-2-6
10-2-16. EMERGENCY OBSTRUCTION VIDEO MAP (EOVM)	10-2-7
10-2-17. VOLCANIC ASH	10-2-7

Section 3. Overdue Aircraft

10-3-1. OVERDUE AIRCRAFT	10-3-1
10-3-2. INFORMATION TO BE FORWARDED TO ARTCC	10-3-1
10-3-3. INFORMATION TO BE FORWARDED TO RCC	10-3-1
10-3-4. ALNOT	10-3-2
10-3-5. RESPONSIBILITY TRANSFER TO RCC	10-3-2
10-3-6. AIRCRAFT POSITION PLOTS	10-3-2
10-3-7. ALNOT CANCELLATION	10-3-2

Section 4. Control Actions

10-4-1. TRAFFIC RESTRICTIONS	10-4-1
10-4-2. LIGHTING REQUIREMENTS	10-4-1
10-4-3. TRAFFIC RESUMPTION	10-4-1
10-4-4. COMMUNICATIONS FAILURE	10-4-1

Section 5. Miscellaneous Operations

10-5-1. NAVY FLEET SUPPORT MISSIONS	10-5-1
10-5-2. EXPLOSIVE CARGO	10-5-1

Section 6. Oceanic Emergency Procedures

Paragraph	Page
10-6-1. APPLICATION	10-6-1
10-6-2. PHASES OF EMERGENCY	10-6-1
10-6-3. ALERTING SERVICE AND SPECIAL ASSISTANCE	10-6-1
10-6-4. INFLIGHT CONTINGENCIES	10-6-2
10-6-5. SERVICES TO RESCUE AIRCRAFT	10-6-3

Section 7. Ground Missile Emergencies

10-7-1. INFORMATION RELAY	10-7-1
10-7-2. IFR AND SVFR MINIMA	10-7-1
10-7-3. VFR MINIMA	10-7-1
10-7-4. SMOKE COLUMN AVOIDANCE	10-7-1
10-7-5. EXTENDED NOTIFICATION	10-7-1

Chapter 11. Traffic Management Procedures

Section 1. General

11-1-1. DUTY RESPONSIBILITY	11-1-1
11-1-2. DUTIES AND RESPONSIBILITIES	11-1-1

Chapter 12. Canadian Airspace Procedures

Section 1. General Control

12-1-1. APPLICATION	12-1-1
12-1-2. AIRSPACE CLASSIFICATION	12-1-1
12-1-3. ONE THOUSAND-ON-TOP	12-1-1
12-1-4. SEPARATION	12-1-1
12-1-5. DEPARTURE CLEARANCE/COMMUNICATION FAILURE	12-1-2
12-1-6. PARACHUTE JUMPING	12-1-2
12-1-7. SPECIAL VFR (SVFR)	12-1-2

Chapter 13. Decision Support Tools

Section 1. User Request Evaluation Tool (URET) – En Route

13-1-1. DESCRIPTION	13-1-1
13-1-2. CONFLICT DETECTION AND RESOLUTION	13-1-1
13-1-3. TRIAL PLANNING	13-1-1
13-1-4. URET-BASED CLEARANCES	13-1-1
13-1-5. THE AIRCRAFT LIST (ACL) AND FLIGHT DATA MANAGEMENT	13-1-2
13-1-6. RECORDING OF CONTROL DATA	13-1-2
13-1-7. ACKNOWLEDGEMENT OF AUTOMATED NOTIFICATION	13-1-2
13-1-8. CURRENCY OF TRAJECTORY INFORMATION	13-1-2
13-1-9. DELAY REPORTING	13-1-2
13-1-10. OVERDUE AIRCRAFT	13-1-3
13-1-11. USE OF GRAPHICS PLAN DISPLAY (GPD)	13-1-3
13-1-12. FORECAST WINDS	13-1-3
13-1-13. INTERFACILITY CONNECTIVITY	13-1-3
13-1-14. PRIMARY RDP/FDP OUTAGES	13-1-3

Section 2. Ocean21 – Oceanic

Paragraph	Page
13-2-1. DESCRIPTION	13-2-1
13-2-2. CONFLICT DETECTION AND RESOLUTION	13-2-1
13-2-3. INFORMATION MANAGEMENT	13-2-2
13-2-4. CONTROLLER PILOT DATA LINK COMMUNICATIONS (CPDLC)	13-2-3
13-2-5. COORDINATION	13-2-4
13-2-6. TEAM RESPONSIBILITIES – MULTIPLE PERSON OPERATION	13-2-4

Appendices

APPENDIX A. AIRCRAFT INFORMATION	A-1
APPENDIX B. AIRCRAFT INFORMATION HELICOPTERS/ROTORCRAFTS ...	B-1
APPENDIX C. AIRCRAFT INFORMATION SPECIFIC HOMEBUILT/EXPERIMENTAL AIRCRAFT	C-1
APPENDIX D. STANDARD OPERATING PRACTICE (SOP) FOR THE TRANSFER OF POSITION RESPONSIBILITY	D-1
PILOT/CONTROLLER GLOSSARY	PCG-1
INDEX	I-1
OFFICES OF PRIMARY INTEREST	OPI-1

Chapter 1. Introduction

Section 1. General

1-1-1. PURPOSE

This order prescribes air traffic control procedures and phraseology for use by persons providing air traffic control services. Controllers are required to be familiar with the provisions of this order that pertain to their operational responsibilities and to exercise their best judgment if they encounter situations that are not covered by it.

1-1-2. DISTRIBUTION

This order is distributed to selected offices in Washington Headquarters, Regional Offices, the Technical Center, and the Aeronautical Center. Also, copies are sent to all air traffic control facilities, all international aviation field offices, and the interested aviation public.

1-1-3. CANCELLATION

FAA Order 7110.65N, Air Traffic Control, dated February 21, 2002, and all changes to it are canceled.

1-1-4. EXPLANATION OF MAJOR CHANGES

The significant changes to this order are identified in the Explanation of Changes page(s). It is advisable to retain the page(s) throughout the duration of the basic order. If further information is desired, direct questions through the appropriate facility/region staff to the office shown in parentheses following the change.

1-1-5. EFFECTIVE DATE

This order is effective **February 19, 2004**.

1-1-6. RECOMMENDATIONS FOR PROCEDURAL CHANGES

a. Personnel should submit recommended changes in procedures to facility management.

b. Recommendations from other sources should be submitted through appropriate FAA, military, or industry/user channels to Headquarters, FAA, Director of Air Traffic, AAT-1, attention: ATP-100.

1-1-7. PUBLICATION AND DELIVERY DATES

a. This order and its changes are scheduled to be published according to TBL 1-1-1.

TBL 1-1-1

Publications Timetable

Basic or Change	Cutoff Date for Submission	Effective Date of Publication
7110.65P Basic	8/7/03	2/19/04
Change 1	2/19/04	8/5/04
Change 2	8/5/04	2/17/05
Change 3	2/17/05	8/4/05
7110.65R Basic	8/4/05	2/16/06

b. If an FAA facility **has not** received the order/changes at least 30 days before the above effective dates, the facility shall notify its regional distribution officer.

c. If a military facility **has not** received the order/changes at least 30 days before the above effective dates, the facility shall notify its appropriate military headquarters. (See TBL 1-1-2.)

TBL 1-1-2

Military Distribution Contacts

Military Headquarters	DSN	Commercial
U.S. Army USAASA	656-4868	(703) 806-4868
U.S. Air Force		Contact Local *NIMA Customer Account Representative
U.S. Navy CNO (N885F)	224-2710	(703) 614-2710
*NIMA-National Imagery and Mapping Agency		

1-1-8. PROCEDURAL LETTERS OF AGREEMENT

Procedures/minima which are applied jointly or otherwise require the cooperation or concurrence of more than one facility/organization must be documented in a letter of agreement. Letters of agreement only supplement this order. Any minima they specify must not be less than that specified herein unless appropriate military authority has authorized application of reduced separation between military aircraft.

REFERENCE-

FAAO 7110.65, ATC Service, Para 2-1-1.
FAAO 7210.3, Letters of Agreement, Para 4-3-1.

1-1-9. CONSTRAINTS GOVERNING SUPPLEMENTS AND PROCEDURAL DEVIATIONS

a. Exceptional or unusual requirements may dictate procedural deviations or supplementary procedures to this order. Prior to implementing supplemental or any procedural deviation that alters the level, quality, or degree of service, obtain prior approval from the Director of Air Traffic, AAT-1.

b. If military operations or facilities are involved, prior approval by the following appropriate headquarters is required for subsequent interface with FAA. (See TBL 1-1-3.)

TBL 1-1-3

Military Operations Interface Offices

Branch	Address
U.S. Navy	CNO Office of the Chief of Naval Operations (N885F) 2000 The Pentagon Washington, D.C. 20350-2000
U.S. Air Force	HQ AFFSA/XA 1535 Command Drive Suite D302 Andrews AFB, MD 20762-7002
U.S. Army	Director USAASA (MOAS-AS) 9325 Gunston Road, Suite N319 Ft. Belvoir, VA 22060-5582

NOTE-

Terminal: Headquarters USAF has delegated to Major Air Command, Directors of Operations (MAJCOM/DOs) authority to reduce same runway separation standards for military aircraft. These are specified and approved by affected ATC and user units. When applied, appropriate advisories may be required; e.g., "(A/C call sign) continue straight ahead on right side; F-16 landing behind on left." "(A/C call sign) hold position on right side; F-5 behind on left."

REFERENCE-

FAAO 7110.65, Use of Active Runways, Para 3-1-3

Section 2. Terms of Reference

1-2-1. WORD MEANINGS

As used in this manual:

a. *Shall*, or an action verb in the imperative sense, means a procedure is mandatory.

EXAMPLE-

The transferring controller *shall* forward this data to the receiving controller.

Issue an alternative clearance.

Authorize the aircraft to taxi.

Do not clear an aircraft to land on or takeoff from a closed runway.

b. *Should* means a procedure is recommended.

c. *May* or *need not* means a procedure is optional.

d. *Will* means futurity, not a requirement for the application of a procedure.

e. Singular words include the plural.

f. Plural words include the singular.

g. *Aircraft* means the airframe, crew members, or both.

h. *Approved separation* means separation in accordance with the applicable minima in this manual.

i. *Altitude* means indicated altitude mean sea level (MSL), flight level (FL), or both.

j. *Miles* means nautical miles unless otherwise specified, and means statute miles in conjunction with visibility.

k. *Course, bearing, azimuth, heading, and wind direction* information shall always be magnetic unless specifically stated otherwise.

l. *Time* when used for ATC operational activities, is the hour and the minute in Coordinated Universal Time (UTC). Change to the next minute is made at the minute plus 30 seconds, except time checks are given to the nearest quarter minute.

m. *Runway* means the runway used by aircraft, and in discussions of separation standards is

applicable to helipads with accompanying takeoff/landing courses. (See Pilot/Controller Glossary term– Runway.)

n. Flight operations in accordance with the options of *due regard* or *operational* obligates the authorized state aircraft commander to:

1. Separate his/her aircraft from all other air traffic; and

2. Assure that an appropriate monitoring agency assumes responsibility for search and rescue actions; and

3. Operate under at least one of the following conditions:

(a) In visual meteorological conditions (VMC); or

(b) Within radar surveillance and radio communications of a surface radar facility; or

(c) Be equipped with airborne radar that is sufficient to provide separation between his/her aircraft and any other aircraft he/she may be controlling and other aircraft; or

(d) Operate within Class G airspace.

(e) An understanding between the pilot and controller regarding the intent of the pilot and the status of the flight should be arrived at before the aircraft leaves ATC frequency.

NOTE-

1. A pilot's use of the phrase "Going Tactical" does not indicate "Due Regard." An understanding between the pilot and controller regarding the intent of the pilot and the status of the flight should be arrived at before the aircraft leaves air traffic control (ATC) frequency.

2. The above conditions provide for a level of safety equivalent to that normally given by International Civil Aviation Organization (ICAO) ATC agencies and fulfills U.S. Government obligations under Article 3 of the Chicago Convention of 1944 (Reference (d)), which stipulates there must be "due regard for the safety of navigation of civil aircraft" when flight is not being conducted under ICAO flight procedures.

o. *CFR* means Code of Federal Regulations.

FIG 1-2-1
Divergence

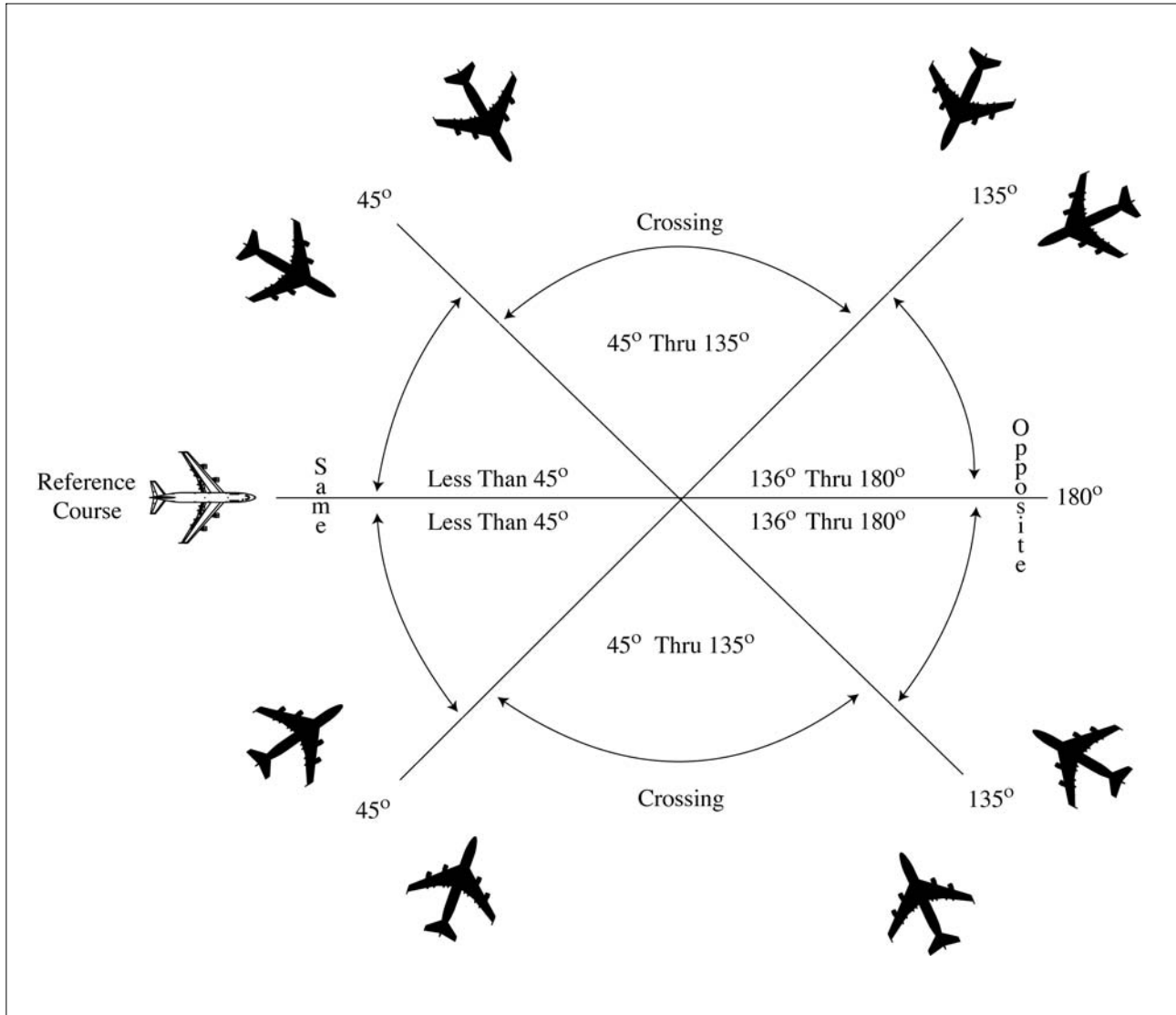

1-2-2. COURSE DEFINITIONS

The following definitions shall be used in the application of the separation criteria in this order.

NOTE-

The term "protected airspace," as used in this paragraph, is the airspace equal to one half the required applicable lateral separation on either side of an aircraft along its projected flight path. If the protected airspace of two aircraft does not overlap, applicable lateral separation is ensured.

a. **SAME COURSES** are courses whose protected airspaces are coincident, overlap, or intersect and whose angular difference is less than 45 degrees. (See FIG 1-2-1.)

b. **CROSSING COURSES** are intersecting courses whose angular difference is 45 through 135 degrees inclusive. (See FIG 1-2-1.)

c. **OPPOSITE/RECIPROCAL COURSES** are courses whose protected airspaces are coincident, overlap, or intersect and whose angular difference is greater than 135 degrees through 180 degrees inclusive. (See FIG 1-2-1.)

1-2-3. NOTES

Statements of fact, or of a prefatory or explanatory nature relating to directive material, are set forth as notes.

1-2-4. REFERENCES

As used in this order, references direct attention to an additional or supporting source of information such as FAA, NWS, and other agencies' orders, directives, notices, CFRs, and Advisory Circulars (ACs).

1-2-5. ANNOTATIONS

Revised, reprinted, or new pages are marked as follows:

a. The change number and the effective date are printed on each revised or additional page.

b. A page that does not require a change is reprinted in its original form.

c. Bold vertical lines in the margin of changed pages indicate the location of substantive revisions to the order. Bold vertical lines adjacent to the title of a chapter, section, or paragraph means that extensive changes have been made to that chapter, section, or paragraph.

d. Paragraphs/sections annotated with *EN ROUTE* or *TERMINAL* are only to be applied by the designated type facility. When they are not so designated, the paragraphs/sections apply to both types of facilities (en route and terminal).

e. The annotation, *USAF* for the U.S. Air Force, *USN* for the U.S. Navy, and *USA* for the U.S. Army denotes that the procedure immediately following the annotation applies only to the designated service.

REFERENCE-
FAAO 7110.65, Military Procedures, Para 2-1-12

f. **WAKE TURBULENCE APPLICATION** inserted within a paragraph means that the remaining information in the paragraph requires the application of wake turbulence procedures.

g. The annotation *PHRASEOLOGY* denotes the prescribed words and/or phrases to be used in communications.

NOTE-
Controllers may, after first using the prescribed phraseology for a specific procedure, rephrase the message to ensure the content is understood. Good judgement shall be exercised when using nonstandard phraseology.

h. The annotation *EXAMPLE* provides a sample of the way the prescribed phraseology associated with the preceding paragraph(s) will be used. If the preceding paragraph(s) does (do) not include specific prescribed phraseology, the *EXAMPLE* merely denotes suggested words and/or phrases that may be used in communications.

NOTE-
The use of the exact text contained in an example not preceded with specific prescribed phraseology is not mandatory. However, the words and/or phrases are expected, to the extent practical, to approximate those used in the example.

1-2-6. ABBREVIATIONS

As used in this manual, the following abbreviations have the meanings indicated. (See TBL 1-2-1.)

TBL 1-2-1
FAA Order 7110.65 Abbreviations

Abbreviation	Meaning
AAR	Airport acceptance rate
AAT-1	Director of Air Traffic
AC	Advisory Circular
ACC	Area Control Center
ACE-IDS	ASOS Controller Equipment- Information Display System
ACL	Aircraft list
ACLS	Automatic Carrier Landing System
ADC	Aerospace Defense Command
ADIZ	Air Defense Identification Zone (to be pronounced "AY DIZ")
ADS	Automatic Dependent Surveillance
ADS-B	Automatic Dependent Surveillance Broadcast
ADS-C	Automatic Dependent Surveillance Contract
AIDC	ATS Interfacility Data Communications
AIM	Aeronautical Information Manual
AIRMET	Airmen's meteorological information
ALERFA	Alert phase code (Alerting Service)
ALNOT	Alert notice
ALS	Approach Light System
ALTRV	Altitude reservation
AMASS	Airport Movement Area Safety System
AMB	Ambiguity-A disparity greater than 2 miles exists between the position declared for a target by ATTS and another facility's computer declared position during interfacility handoff

Abbreviation	Meaning
AMVER	Automated Mutual Assistance Vessel Rescue System
ANG	Air National Guard
APR	ATC preferred route
ARINC	Aeronautical Radio Incorporated
ARIP	Air refueling initial point
ARS	Air Traffic System Requirements Service
ARSR	Air route surveillance radar
ARTCC	Air Route Traffic Control Center
ARTS	Automated Radar Terminal System
ASD	Aircraft Situation Display
ASDE	Airport surface detection equipment
ASDE-X . . .	Airport Surface Detection Equipment System – Model X
ASOS	Automated Surface Observing System
ASR	Airport surveillance radar
ATA	Air Traffic Airspace Management Program
ATC	Air traffic control
ATCAA	ATC assigned airspace
ATCSCC . . .	Air Traffic Control System Command Center
ATIS	Automatic Terminal Information Service
ATP	Air Traffic Planning and Procedures
ATS	Air Traffic Service
ATTS	Automated Terminal Tracking Systems
AWOS	Automated Weather Observing System
BASE	Cloud base
CA	Conflict Alert
CARCAH . . .	Chief, Aerial Reconnaissance Coordination, All Hurricanes
CARF	Central Altitude Reservation Function
CARTS	Common ARTS
CAT	Clear air turbulence
CDT	Controlled departure time
CENRAP . . .	Center Radar ARTS Presentation
CEP	Central East Pacific
CERAP	Combined Center/RAPCON
CFR	Code of Federal Regulations
CNS	Continuous
CPDLC	Controller Pilot Data Link Communications
CPME	Calibration Performance Monitor Equipment
CTA	Control Area
CTRD	Certified Tower Radar Display

Abbreviation	Meaning
CVFP	Chartered Visual Flight Procedure
CWA	Center Weather Advisory
DARC	Direct Access Radar Channel
DETRESFA . .	Distress Phase code (Alerting Service)
DF	Direction finder
DH	Decision height
DME	Distance measuring equipment compatible with TACAN
DOE	Department of Energy
DP	Instrument Departure Procedure
DR	Dead reckoning
DRT	Diversion recovery tool
DSR	Display System Replacement
DTM	Digital Terrain Map
DVFR	Defense Visual Flight Rules
DVRSN	Diversion
EA	Electronic Attack
EAS	En Route Automation System
EDCT	Expect Departure Clearance Time
EFC	Expect further clearance
ELP	Emergency Landing Pattern
ELT	Emergency locator transmitter
EOS	End Service
EOVM	Emergency obstruction video map
ERIDS	En Route Information Display System
ETA	Estimated time of arrival
ETMS	Enhanced Traffic Management System
FAA	Federal Aviation Administration
FAAO	FAA Order
FANS	Future Air Navigation System
FDIO	Flight Data Input/Output
FDP	Flight data processing
FIR	Flight Information Region
FL	Flight level
FLIP	Flight Information Publication
FLY	Fly or flying
FMS	Flight Management System
FMSF	Flight Management System Procedure
FSM	Flight Schedule Monitor
FSS	Flight Service Station
GCA	Ground controlled approach
GNSS	Global Navigation Satellite System
GPD	Graphics Plan Display
GPS	Global Positioning System

Abbreviation	Meaning
GS	Ground stop
HAR	High Altitude Redesign
HERT	Host Embedded Route Text
HF/RO	High Frequency/Radio Operator
HIRL	High intensity runway lights
ICAO	International Civil Aviation Organization
IDENT	Aircraft identification
IDS	Information Display System
IFR	Instrument flight rules
IFSS	International Flight Service Station
ILS	Instrument Landing System
INCERFA	Uncertainty Phase code (Alerting Service)
INREQ	Information request
INS	Inertial Navigation System
IR	IFR military training route
IRU	Inertial Reference Unit
ITWS	Integrated Terminal Weather System
JATO	Jet assisted takeoff
LAHSO	Land and Hold Short Operations
LOA	Letter of Agreement
LLWS	Low Level Wind Shear Alert System
LLWS NE	Low Level Wind Shear Alert System Network Expansion
LLWS-RS	Low Level Wind Shear Alert System Relocation/Sustainment
LLWS	Low Level Wind Shear
L/MF	Low/medium frequency
LORAN	Long Range Navigation System
LTD	Along Track Distance
Mach	Mach number
MALS	Medium Intensity Approach Light System
MALSR	Medium Approach Light System with runway alignment indicator lights
MAP	Missed approach point
MARSA	Military authority assumes responsibility for separation of aircraft
MCA	Minimum crossing altitude
MCI	Mode C Intruder
MDA	Minimum descent altitude
MDM	Main display monitor
MEA	Minimum en route (IFR) altitude
MEARTS	Micro En Route Automated Radar Tracking System
METAR	Aviation Routine Weather Report
MIA	Minimum IFR altitude

Abbreviation	Meaning
MIAWS	Medium Intensity Airport Weather System
MIRL	Medium intensity runway lights
MLS	Microwave Landing System
MNPS	Minimum Navigation Performance Specification
MNT	Mach Number Technique
MOA	Military operations area
MOCA	Minimum obstruction clearance altitude
MRA	Minimum reception altitude
MSAW	Minimum Safe Altitude Warning
MSL	Mean sea level
MTI	Moving target indicator
MTR	Military training route
MVA	Minimum vectoring altitude
NADIN	National Airspace Data Interchange Network
NAR	National Automation Request
NAS	National Airspace System
NAT	ICAO North Atlantic Region
NBCAP	National Beacon Code Allocation Plan
NDB	Nondirectional radio beacon
NHOP	National Hurricane Operations Plan
NIDS	National Institute for Discovery Sciences
NM	Nautical mile
NOAA	National Oceanic and Atmospheric Administration
NOPAC	North Pacific
NORAD	North American Aerospace Defense Command
NOS	National Ocean Service
NOTAM	Notice to Airmen
NRP	North American Route Program
NRR	Nonrestrictive Route
NRS	Navigation Reference System
NTZ	No transgression zone
NWS	National Weather Service
NWSOP	National Winter Storm Operations Plan
ODALS	Omnidirectional Approach Lighting System
OID	Operator Interface Device
ONER	Oceanic Navigational Error Report
OS	Operations Supervisor
OTR	Oceanic transition route
PAPI	Precision Approach Path Indicators

Abbreviation	Meaning
PAR	Precision approach radar
PAR	Preferred arrival route
PBCT	Proposed boundary crossing time
P/CG	Pilot/Controller Glossary
PDAR	Preferential departure arrival route
PDC	Pre-Departure Clearance
PDR	Preferential departure route
PIDP	Programmable indicator data processor
PPI	Plan position indicator
PTP	Point-to-point
PVD	Plan view display
RA	Radar Associate
RAIL	Runway alignment indicator lights
RAPCON . . .	Radar Approach Control Facility (USAF)
RATCF	Radar Air Traffic Control Facility (USN)
RBS	Radar bomb scoring
RCC	Rescue Coordination Center
RCLS	Runway Centerline System
RCR	Runway condition reading
RDP	Radar data processing
RE	Recent (used to qualify weather phenomena such as rain, e.g. recent rain = RERA)
REIL	Runway end identifier lights
RNAV	Area navigation
RNP	Required Navigation Performance
RTQC	Real-Time Quality Control
RVR	Runway visual range
RVSM	Reduced Vertical Separation Minimum
RVV	Runway visibility value
SAR	Search and rescue
SATCOM . . .	Satellite Communication
SELCAL	Selective Calling System
SFA	Single frequency approach
SFO	Simulated flameout
SID	Standard Instrument Departure
SIGMET	Significant meteorological information
SPECI	Nonroutine (Special) Aviation Weather Report
STAR	Standard terminal arrival
STARS	Standard Terminal Automation Replacement System
STMC	Supervisory Traffic Management Coordinator

Abbreviation	Meaning
STMCIC	Supervisory Traffic Management Coordinator-in-charge
STOL	Short takeoff and landing
SURPIC	Surface Picture
SVFR	Special Visual Flight Rules
TAA	Terminal arrival area
TACAN	TACAN UHF navigational aid (omnidirectional course and distance information)
TCAS	Traffic Alert and Collision Avoidance System
TCAS	Traffic Alert and Collision Avoidance System
TCDD	Tower cab digital display
TDLS	Terminal Data Link System
TDW	Tower display workstation
TDWR	Terminal Doppler Weather Radar
TDZL	Touchdown Zone Light System
TMC	Traffic Management Coordinator
TMU	Traffic Management Unit
TRACON . . .	Terminal Radar Approach Control
TRSA	Terminal radar service area
UFO	Unidentified flying object
UHF	Ultra high frequency
URET	User request evaluation tool
USA	United States Army
USAF	United States Air Force
USN	United States Navy
UTC	Coordinated universal time
UTM	Unsuccessful transmission message
UUA	Urgent pilot weather report
VFR	Visual flight rules
VHF	Very high frequency
VMC	Visual meteorological conditions
VNAV	Vertical Navigation
VOR	VHF navigational aid (omnidirectional course information)
VOR/DME . .	Collocated VOR and DME navigational aids (VHF course and UHF distance information)
VORTAC . . .	Collocated VOR and TACAN navigation aids (VHF and UHF course and UHF distance information)
VR	VFR military training route
VSCS	Voice Switching and Control System

Abbreviation	Meaning
WAAS	Wide Area Augmentation System
WARP	Weather and Radar Processing
WATRS	West Atlantic Route System
WSO	Weather Service Office
WSP	Weather System Processor
WST	Convective SIGMET

Chapter 2. General Control

Section 1. General

2-1-1. ATC SERVICE

The primary purpose of the ATC system is to prevent a collision between aircraft operating in the system and to organize and expedite the flow of traffic. In addition to its primary function, the ATC system has the capability to provide (with certain limitations) additional services. The ability to provide additional services is limited by many factors, such as the volume of traffic, frequency congestion, quality of radar, controller workload, higher priority duties, and the pure physical inability to scan and detect those situations that fall in this category. It is recognized that these services cannot be provided in cases in which the provision of services is precluded by the above factors. Consistent with the aforementioned conditions, controllers shall provide additional service procedures to the extent permitted by higher priority duties and other circumstances. The provision of additional services is not optional on the part of the controller, but rather is required when the work situation permits. Provide air traffic control service in accordance with the procedures and minima in this order except when:

a. A deviation is necessary to conform with ICAO Documents, National Rules of the Air, or special agreements where the U.S. provides air traffic control service in airspace outside the U.S. and its possessions or:

NOTE-

Pilots are required to abide by CFRs or other applicable regulations regardless of the application of any procedure or minima in this order.

b. Other procedures/minima are prescribed in a letter of agreement, FAA directive, or a military document, or:

NOTE-

These procedures may include altitude reservations, air refueling, fighter interceptor operations, law enforcement, etc.

REFERENCE-

FAAO 7110.65, Procedural Letters of Agreement, Para 1-1-8

c. A deviation is necessary to assist an aircraft when an emergency has been declared.

REFERENCE-

FAAO 7110.65, Safety Alert, Para 2-1-6

FAAO 7110.65, Emergencies, Chapter 10

FAAO 7110.65, Merging Target Procedures, Para 5-1-8

2-1-2. DUTY PRIORITY

a. Give first priority to separating aircraft and issuing safety alerts as required in this order. Good judgment shall be used in prioritizing all other provisions of this order based on the requirements of the situation at hand.

REFERENCE-

FAAO 7110.65, Safety Alert, Para 2-1-6

NOTE-

Because there are many variables involved, it is virtually impossible to develop a standard list of duty priorities that would apply uniformly to every conceivable situation. Each set of circumstances must be evaluated on its own merit, and when more than one action is required, controllers shall exercise their best judgment based on the facts and circumstances known to them. That action which is most critical from a safety standpoint is performed first.

b. Provide additional services to the extent possible, contingent only upon higher priority duties and other factors including limitations of radar, volume of traffic, frequency congestion, and workload.

2-1-3. PROCEDURAL PREFERENCE

a. Use automation procedures in preference to nonautomation procedures when workload, communications, and equipment capabilities permit.

b. Use radar separation in preference to nonradar separation when it will be to an operational advantage and workload, communications, and equipment permit.

c. Use nonradar separation in preference to radar separation when the situation dictates that an operational advantage will be gained.

NOTE-

One situation may be where vertical separation would preclude excessive vectoring.

2-1-4. OPERATIONAL PRIORITY

Provide air traffic control service to aircraft on a “first come, first served” basis as circumstances permit, except the following:

NOTE-

It is solely the pilot's prerogative to cancel an IFR flight plan. However, a pilot's retention of an IFR flight plan does not afford priority over VFR aircraft. For example, this does not preclude the requirement for the pilot of an arriving IFR aircraft to adjust his/her flight path, as necessary, to enter a traffic pattern in sequence with arriving VFR aircraft.

a. An aircraft in distress has the right of way over all other air traffic.

REFERENCE-

14 CFR Section 91.113(c).

b. Provide priority to civilian air ambulance flights “LIFEGUARD.” Air carrier/taxi usage of the “LIFEGUARD” call sign, indicates that operational priority is requested. When verbally requested, provide priority to military air evacuation flights (AIR EVAC, MED EVAC) and scheduled air carrier/air taxi flights. Assist the pilots of air ambulance/evacuation aircraft to avoid areas of significant weather and turbulent conditions. When requested by a pilot, provide notifications to expedite ground handling of patients, vital organs, or urgently needed medical materials.

NOTE-

It is recognized that heavy traffic flow may affect the controller's ability to provide priority handling. However, without compromising safety, good judgement shall be used in each situation to facilitate the most expeditious movement of a lifeguard aircraft.

c. Provide maximum assistance to SAR aircraft performing a SAR mission.

REFERENCE-

FAAO 7110.65, Providing Assistance, Para 10-1-3

d. Expedite the movement of presidential aircraft and entourage and any rescue support aircraft as well as related control messages when traffic conditions and communications facilities permit.

NOTE-

As used herein the terms presidential aircraft and entourage include aircraft and entourage of the President, Vice President, or other public figures when designated by the White House.

REFERENCE-

FAAO 7110.65, Aircraft Identification, Para 2-4-20

FAAO 7110.65, Departure Clearances, Para 4-3-2.

FAAO 7210.3, Advance Coordination, Para 5-1-1.

e. Provide special handling, as required to expedite Flight Check aircraft.

NOTE-

It is recognized that unexpected wind conditions, weather, or heavy traffic flows may affect controller's ability to provide priority or special handling at the specific time requested.

REFERENCE-

FAAO 7110.65, Flight Check Aircraft, Para 9-1-3

f. Expedite movement of NIGHT WATCH aircraft when NAOC (pronounced NA-YOCK) is indicated in the remarks section of the flight plan or in air/ground communications.

NOTE-

The term “NAOC” will not be a part of the call sign but may be used when the aircraft is airborne to indicate a request for special handling.

REFERENCE-

FAAO 7610.4, Applications, Para 12-1-1.

g. Provide expeditious handling for any civil or military aircraft using the code name “FLYNET.”

REFERENCE-

FAAO 7110.65, FLYNET, Para 9-3-6

FAAO 7610.4, “FLYNET” Flights, Nuclear Emergency Teams, Para 12-4-1.

h. Provide expeditious handling of aircraft using the code name “Garden Plot” only when CARF notifies you that such priority is authorized. Refer any questions regarding flight procedures to CARF for resolution.

NOTE-

Garden Plot flights require priority movement and are coordinated by the military with CARF. State authority will contact the Regional Administrator to arrange for priority of National Guard troop movements within a particular state.

i. Provide special handling for USAF aircraft engaged in aerial sampling missions using the code name “SAMP.”

REFERENCE-

FAAO 7110.65, SAMP, Para 9-3-16

FAAO 7210.3, Atmosphere Sampling For Nuclear Contamination, Para 5-3-4.

FAAO 7610.4, Atmospheric Sampling For Nuclear Contamination, Para 12-4-3.

j. Provide maximum assistance to expedite the movement of interceptor aircraft on active air defense missions until the unknown aircraft is identified.

k. Expedite movement of Special Air Mission aircraft when SCOOT is indicated in the remarks section of the flight plan or in air/ground communications.

NOTE–

The term “SCOOT” will not be part of the call sign but may be used when the aircraft is airborne to indicate a request for special handling.

REFERENCE–

FAAO 7110.65, Law Enforcement Operations by Civil and Military Organizations, Para 9–3–1.

FAAO 7610.4, Applications, Para 12–7–1.

l. When requested, provide priority handling to TEAL and NOAA mission aircraft.

NOTE–

Priority handling may be requested by the pilot, or via telephone from CARCAH or the 53rd Weather Reconnaissance Squadron (53WRS) operations center personnel, or in the remarks section of the flight plan.

REFERENCE–

FAAO 7110.65, Weather Reconnaissance Flights, Para 9–3–18

m. IFR aircraft shall have priority over SVFR aircraft.

REFERENCE–

FAAO 7110.65, Chapter 7, Section 5, Special VFR (SVFR).

n. Providing priority and special handling to expedite the movement of OPEN SKIES observation and demonstration flights.

NOTE–

An OPEN SKIES aircraft has priority over all “regular” air traffic. “Regular” is defined as all aircraft traffic other than:

- 1. Emergencies.*
- 2. Aircraft directly involved in presidential movement.*
- 3. Forces or activities in actual combat.*
- 4. Lifeguard, MED EVAC, AIR EVAC and active SAR missions.*

REFERENCE–

FAAO 7110.65 OPEN SKIES Treaty Aircraft, Para 9–3–21

FAAO 7210.3, OPEN SKIES Treaty Aircraft, Para 5–3–7.

Treaty on OPEN SKIES, Treaty Document, 102–37.

o. Aircraft operating under the North American Route Program (NRP) and in airspace identified in the High Altitude Redesign (HAR) program, are not subject to route limiting restrictions (e.g., published preferred IFR routes, letter of agreement requirements, standard operating procedures).

REFERENCE–

FAAO 7110.65, En Route Data Entries, Para 2–3–2

FAAO 7110.65, North American Route Program (NRP) Information, Para 2–2–15

FAAO 7110.65, Route or Altitude Amendments, Para 4–2–5

FAAO 7210.3, Chapter 17, Section 14, North American Route Program.

p. If able, provide priority handling to diverted flights. Priority handling may be requested via use of “DVRSN” in the remarks section of the flight plan or by the flight being placed on the Diversion Recovery Tool (DRT).

REFERENCE–

FAAO 7210.3, Diversion Recovery, Para 17–4–5.

2–1–5. EXPEDITIOUS COMPLIANCE

a. Use the word “immediately” only when expeditious compliance is required to avoid an imminent situation.

b. Use the word “expedite” only when prompt compliance is required to avoid the development of an imminent situation. If an “expedite” climb or descent clearance is issued by ATC, and subsequently the altitude to maintain is changed or restated without an expedite instruction, the expedite instruction is canceled.

c. In either case, if time permits, include the reason for this action.

2–1–6. SAFETY ALERT

Issue a safety alert to an aircraft if you are aware the aircraft is in a position/altitude which, in your judgment, places it in unsafe proximity to terrain, obstructions, or other aircraft. Once the pilot informs you action is being taken to resolve the situation, you may discontinue the issuance of further alerts. Do not assume that because someone else has responsibility for the aircraft that the unsafe situation has been observed and the safety alert issued; inform the appropriate controller.

If a TRACON has given control of an aircraft to one of its remote towers, and the tower has aural and visual MSAW alert capability, the TRACON does not have to inform the tower controller if an alert is observed for that aircraft when it is within the remote tower’s aural alarm area.

NOTE–

1. *The issuance of a safety alert is a first priority (see para 2–1–2 Duty Priority) once the controller observes and recognizes a situation of unsafe aircraft proximity to terrain, obstacles, or other aircraft. Conditions, such as workload, traffic volume, the quality/limitations of the radar system, and the available lead time to react are factors in determining whether it is reasonable for the controller to observe and recognize such situations. While a controller cannot see immediately the development of every situation where a safety alert must be issued, the*

controller must remain vigilant for such situations and issue a safety alert when the situation is recognized.

2. *Recognition of situations of unsafe proximity may result from MSAW/E-MSAW/LAAS, automatic altitude readouts, Conflict/Mode C Intruder Alert, observations on a PAR scope, or pilot reports.*

3. *Once the alert is issued, it is solely the pilot's prerogative to determine what course of action, if any, will be taken.*

a. *Terrain/Obstruction Alert. Immediately issue/initiate an alert to an aircraft if you are aware the aircraft is at an altitude which, in your judgment, places it in unsafe proximity to terrain/obstructions. Issue the alert as follows:*

PHRASEOLOGY-

LOW ALTITUDE ALERT (call sign),

CHECK YOUR ALTITUDE IMMEDIATELY.

THE (as appropriate) MEA/MVA/MOCA/MIA IN YOUR AREA IS (altitude),

or if an aircraft is past the final approach fix (nonprecision approach),

or the outer marker,

or the fix used in lieu of the outer marker (precision approach),

and, if known, issue

THE (as appropriate) MDA/DH IS (altitude).

b. *Aircraft Conflict/Mode C Intruder Alert. Immediately issue/initiate an alert to an aircraft if you are aware of another aircraft at an altitude which you believe places them in unsafe proximity. If feasible, offer the pilot an alternate course of action.*

c. *When an alternate course of action is given, end the transmission with the word "immediately."*

PHRASEOLOGY-

TRAFFIC ALERT (call sign) (position of aircraft) ADVISE YOU TURN LEFT/RIGHT (heading),

and/or

CLIMB/DESCEND (specific altitude if appropriate) IMMEDIATELY.

REFERENCE-

FAAO 7110.65, Conflict Alert (CA) and Mode C Intruder (MCI) Alert, Para 5-14-1

FAAO 7110.65, En Route Minimum Safe Altitude Warning (E-MSAW), Para 5-14-2

FAAO 7110.65, CA/MCI, Para 5-15-6

FAAO 7110.65, Altitude Filters, Para 5-2-23

2-1-7. INFLIGHT EQUIPMENT MALFUNCTIONS

a. *When a pilot reports an inflight equipment malfunction, determine the nature and extent of any special handling desired.*

NOTE-

Inflight equipment malfunctions include partial or complete failure of equipment, which may affect either safety, separation standards, and/or the ability of the flight to proceed under IFR, or in Reduced Vertical Separation Minimum (RVSM) airspace, in the ATC system. Controllers may expect reports from pilots regarding VOR, TACAN, ADF, GPS, RVSM capability, or low frequency navigation receivers, impairment of air-ground communications capability, or other equipment deemed appropriate by the pilot (e.g., airborne weather radar). Pilots should communicate the nature and extent of any assistance desired from ATC.

b. *Provide the maximum assistance possible consistent with equipment, workload, and any special handling requested.*

c. *Relay to other controllers or facilities who will subsequently handle the aircraft, all pertinent details concerning the aircraft and any special handling required or being provided.*

2-1-8. MINIMUM FUEL

If an aircraft declares a state of "minimum fuel," inform any facility to whom control jurisdiction is transferred of the minimum fuel problem and be alert for any occurrence which might delay the aircraft en route.

NOTE-

Use of the term "minimum fuel" indicates recognition by a pilot that his/her fuel supply has reached a state where, upon reaching destination, he/she cannot accept any undue delay. This is not an emergency situation but merely an advisory that indicates an emergency situation is possible should any undue delay occur. A minimum fuel advisory does not imply a need for traffic priority. Common sense and good judgment will determine the extent of assistance to be given in minimum fuel situations. If, at any time, the remaining usable fuel supply suggests the need for traffic priority to ensure a safe landing, the pilot should declare an emergency and report fuel remaining in minutes.

2-1-9. REPORTING ESSENTIAL FLIGHT INFORMATION

Report as soon as possible to the appropriate FSS, airport manager's office, ARTCC, approach control facility, operations office, or military operations office any information concerning components of the NAS or any flight conditions which may have an adverse effect on air safety.

NOTE-

FSSs are responsible for classifying and disseminating Notices to Airmen.

REFERENCE-

*FAAO 7110.65, Timely Information, Para 3-3-3
FAAO 7110.65, Service Limitations, Para 5-1-6
FAAO 7210.3, Periodic Maintenance, Para 3-1-2.
USN, See OPNAVINST 3721.30.*

2-1-10. NAVAID MALFUNCTIONS

a. When an aircraft reports a ground-based NAVAID malfunction, take the following actions:

1. Request a report from a second aircraft.
2. If the second aircraft reports normal operations, continue use and inform the first aircraft. Record the incident on FAA Form 7230-4 or appropriate military form.
3. If the second aircraft confirms the malfunction or in the absence of a second aircraft report, activate the standby equipment or request the monitor facility to activate.
4. If normal operation is reported after the standby equipment is activated, continue use, record the incident on FAA Form 7230-4 or appropriate military form, and notify Airway Facilities (AF) personnel (the Systems Engineer of the ARTCC when an en route aid is involved).
5. If continued malfunction is reported after the standby equipment is activated or the standby equipment cannot be activated, inform AF personnel and request advice on whether or not the aid should be shut down. In the absence of a second aircraft report, advise the AF personnel of the time of the initial aircraft report and the estimated time a second aircraft report could be obtained.

b. When an aircraft reports a GPS anomaly, request the following information and/or take the following actions:

1. Record the following minimum information:

- (a) Aircraft call sign and type.
- (b) Location.
- (c) Altitude.
- (d) Date/time of occurrence.

2. Record the incident on FAA Form 7230-4 or appropriate military form.

3. Broadcast the anomaly report to other aircraft as necessary.

PHRASEOLOGY-

ATTENTION ALL AIRCRAFT, GPS REPORTED UNRELIABLE IN VICINITY/AREA (position).

EXAMPLE-

"Attention all aircraft, GPS reported unreliable in the area 30 miles south of Waco VOR."

c. When an aircraft reports a Wide Area Augmentation System (WAAS) anomaly, request the following information and/or take the following actions:

1. Determine if the pilot has lost all WAAS service.

PHRASEOLOGY-

ARE YOU RECEIVING ANY WAAS SERVICE?

2. If the pilot reports receipt of any WAAS service, acknowledge the report and continue normal operations.

3. If the pilot reports loss of all WAAS service, report as a GPS anomaly using procedures in subpara 2-1-10b.

2-1-11. USE OF MARSAS

a. MARSAS may only be applied to military operations specified in a letter of agreement or other appropriate FAA or military document.

NOTE-

Application of MARSAS is a military command prerogative. It will not be invoked indiscriminately by individual units or pilots. It will be used only for IFR operations requiring its use. Commands authorizing MARSAS will ensure that its implementation and terms of use are documented and coordinated with the control agency having jurisdiction over the area in which the operations are conducted. Terms of use will assign responsibility and provide for separation among participating aircraft.

b. ATC facilities do not invoke or deny MARSAS. Their sole responsibility concerning the use of MARSAS is to provide separation between military aircraft engaged in MARSAS operations and other nonparticipating IFR aircraft.

c. DOD shall ensure that military pilots requesting special-use airspace/ATCAAs have coordinated with the scheduling agency, have obtained approval for entry, and are familiar with the appropriate MARSAs procedures. ATC is not responsible for determining which military aircraft are authorized to enter special-use airspace/ATCAAs.

REFERENCE-

FAAO 7110.65, *Military Aerial Refueling, Para 9-3-12*

2-1-12. MILITARY PROCEDURES

Military procedures in the form of additions, modifications, and exceptions to the basic FAA procedure are prescribed herein when a common procedure has not been attained or to fulfill a specific requirement. They shall be applied by:

- a. ATC facilities operated by that military service.

EXAMPLE-

1. An Air Force facility providing service for an Air Force base would apply USAF procedures to all traffic regardless of class.

2. A Navy facility providing service for a Naval Air Station would apply USN procedures to all traffic regardless of class.

b. ATC facilities, regardless of their parent organization (FAA, USAF, USN, USA), supporting a designated military airport exclusively. This designation determines which military procedures are to be applied.

EXAMPLE-

1. An FAA facility supports a USAF base exclusively; USAF procedures are applied to all traffic at that base.

2. An FAA facility provides approach control service for a Naval Air Station as well as supporting a civil airport; basic FAA procedures are applied at both locations by the FAA facility.

3. A USAF facility supports a USAF base and provides approach control service to a satellite civilian airport; USAF procedures are applied at both locations by the USAF facility.

REFERENCE-

FAAO 7110.65, *Annotations, Para 1-2-5*

c. Other ATC facilities when specified in a letter of agreement.

EXAMPLE-

A USAF unit is using a civil airport supported by an FAA facility- USAF procedures will be applied as specified in a letter of agreement between the unit and the FAA facility to the aircraft of the USAF unit. Basic FAA procedures will be applied to all other aircraft.

2-1-13. FORMATION FLIGHTS

a. Control formation flights as a single aircraft. When individual control is requested, issue advisory information which will assist the pilots in attaining separation. When pilot reports indicate separation has been established, issue control instructions as required.

NOTE-

1. Separation responsibility between aircraft within the formation during transition to individual control rests with the pilots concerned until standard separation has been attained.

2. Formation join-up and breakaway will be conducted in VFR weather conditions unless prior authorization has been obtained from ATC or individual control has been approved.

REFERENCE-

FAAO 7110.65, *Additional Separation for Formation Flights, Para 5-5-8*

P/CG Term- Formation Flight.

- b. Formation flights in RVSM airspace.

1. For a formation flight operating in RVSM airspace, change the equipment suffix of the flight to indicate non-RVSM, regardless of RVSM status.

2. Upon flight breakup, query each aircraft of their RVSM status and make appropriate equipment suffix changes to indicate their status.

2-1-14. COORDINATE USE OF AIRSPACE

a. Ensure that the necessary coordination has been accomplished before you allow an aircraft under your control to enter another controller's area of jurisdiction.

b. Before you issue control instructions directly or relay through another source to an aircraft which is within another controller's area of jurisdiction that will change that aircraft's heading, route, speed, or altitude, ensure that coordination has been accomplished with each of the controllers listed below whose area of jurisdiction is affected by those instructions unless otherwise specified by a letter of agreement or a facility directive:

1. The controller within whose area of jurisdiction the control instructions will be issued.

2. The controller receiving the transfer of control.

3. Any intervening controller(s) through whose area of jurisdiction the aircraft will pass.

c. If you issue control instructions to an aircraft through a source other than another controller (e.g., ARINC, FSS, another pilot) ensure that the necessary coordination has been accomplished with any controllers listed in subparas b1, 2, and 3, whose area of jurisdiction is affected by those instructions unless otherwise specified by a letter of agreement or a facility directive.

REFERENCE-

FAAO 7110.65, *Control Transfer, Para 2-1-15*
 FAAO 7110.65, *Adjacent Airspace, Para 5-5-10*
 FAAO 7110.65, *Transferring Controller Handoff, Para 5-4-5*
 FAAO 7110.65, *Receiving Controller Handoff, Para 5-4-6*

2-1-15. CONTROL TRANSFER

a. Transfer control of an aircraft in accordance with the following conditions:

1. At a prescribed or coordinated location, time, fix, or altitude; or,

2. At the time a radar handoff and frequency change to the receiving controller have been completed and when authorized by a facility directive or letter of agreement which specifies the type and extent of control that is transferred.

REFERENCE-

FAAO 7110.65, *Coordinate Use of Airspace, Para 2-1-14*
 FAAO 7110.65, *Transferring Controller Handoff, Para 5-4-5*
 FAAO 7110.65, *Receiving Controller Handoff, Para 5-4-6*

b. Transfer control of an aircraft only after eliminating any potential conflict with other aircraft for which you have separation responsibility.

c. Assume control of an aircraft only after it is in your area of jurisdiction unless specifically coordinated or as specified by letter of agreement or a facility directive.

2-1-16. SURFACE AREAS

a. Coordinate with the appropriate nonapproach control tower on an individual aircraft basis before issuing a clearance which would require flight within a surface area for which the tower has responsibility unless otherwise specified in a letter of agreement.

REFERENCE-

FAAO 7210.3, *Letters of Agreement, Para 4-3-1.*
 14 CFR Section 91.127, *Operating on or in the Vicinity of an Airport in Class E Airspace.*
 P/CG Term- *Surface Area.*

b. Coordinate with the appropriate control tower for transit authorization when you are providing radar traffic advisory service to an aircraft that will enter another facility's airspace.

NOTE-

The pilot is not expected to obtain his/her own authorization through each area when in contact with a radar facility.

c. Transfer communications to the appropriate facility, if required, prior to operation within a surface area for which the tower has responsibility.

REFERENCE-

FAAO 7110.65, *Radio Communications Transfer, Para 2-1-17*
 FAAO 7110.65, *Surface Area Restrictions, Para 3-1-1.*
 FAAO 7110.65, *Application, Para 7-6-1*
 14 CFR Section 91.129, *Operations in Class D Airspace.*

2-1-17. RADIO COMMUNICATIONS TRANSFER

a. Transfer radio communications before an aircraft enters the receiving controller's area of jurisdiction unless otherwise coordinated or specified by a letter of agreement or a facility directive.

b. Transfer radio communications by specifying the following:

NOTE-

Radio communications transfer procedures may be specified by a letter of agreement or contained in the route description of an MTR as published in the DOD Planning AP/1B (AP/3).

1. The facility name or location name and terminal function to be contacted. **TERMINAL:** Omit the location name when transferring communications to another controller within your facility; except when instructing the aircraft to change frequency for final approach guidance include the name of the facility.

2. Frequency to use except the following may be omitted:

(a) FSS frequency.

(b) Departure frequency if previously given or published on a DP chart for the procedure issued.

(c) TERMINAL:

(1) Ground or local control frequency if in your opinion the pilot knows which frequency is in use.

(2) The numbers preceding the decimal point if the ground control frequency is in the 121 MHz bandwidth.

EXAMPLE-

“Contact Tower.”

“Contact Ground.”

“Contact Ground Point Seven.”

“Contact Ground, One Two Zero Point Eight.”

“Contact Huntington Radio.”

“Contact Departure.”

“Contact Los Angeles Center, One Two Three Point Four.”

3. Time, fix, altitude, or specifically when to contact a facility. You may omit this when compliance is expected upon receipt.

NOTE-

AIM, para 5-3-1, ARTCC Communications, informs pilots that they are expected to maintain a listening watch on the transferring controller’s frequency until the time, fix, or altitude specified.

PHRASEOLOGY-

CONTACT (facility name or location name and terminal function), (frequency).

If required,

AT (time, fix, or altitude).

c. In situations where an operational advantage will be gained, and following coordination with the receiving controller, you may instruct aircraft on the ground to monitor the receiving controller’s frequency.

EXAMPLE-

“Monitor Tower.”

“Monitor Ground.”

“Monitor Ground Point Seven.”

“Monitor Ground, One Two Zero Point Eight.”

d. In situations where a sector has multiple frequencies or when sectors are combined using multiple frequencies and the aircraft will remain under your jurisdiction, transfer radio communication by specifying the following:

PHRASEOLOGY-

(Identification) CHANGE TO MY FREQUENCY (state frequency).

EXAMPLE-

“United two twenty-two change to my frequency one two three point four.”

REFERENCE-

AIM, Contact Procedures, Para 4-2-3.

e. Avoid issuing a frequency change to helicopters known to be single-piloted during air-taxiing, hovering, or low-level flight. Whenever possible, relay necessary control instructions until the pilot is able to change frequency.

NOTE-

Most light helicopters are flown by one pilot and require the constant use of both hands and feet to maintain control. Although Flight Control Friction Devices assist the pilot, changing frequency near the ground could result in inadvertent ground contact and consequent loss of control. Pilots are expected to advise ATC of their single-pilot status if unable to comply with a frequency change.

REFERENCE-

AIM, Communications, Para 4-3-14.

f. In situations where the controller does not want the pilot to change frequency but the pilot is expecting or may want a frequency change, use the following phraseology.

PHRASEOLOGY-

REMAIN THIS FREQUENCY.

REFERENCE-

FAAO 7110.65, Clearance Information, Para 4-7-1

FAAO 7110.65, Communication Transfer, Para 5-12-9

2-1-18. OPERATIONAL REQUESTS

Respond to a request from another controller, a pilot or vehicle operator by one of the following verbal means:

a. Restate the request in complete or abbreviated terms followed by the word “APPROVED.” The phraseology “APPROVED AS REQUESTED” may be substituted in lieu of a lengthy readback.

PHRASEOLOGY-

(Requested operation) APPROVED.

or

APPROVED AS REQUESTED.

b. State restrictions followed by the word “APPROVED.”

PHRASEOLOGY-

(Restriction and/or additional instructions, requested operation) APPROVED.

c. State the word “UNABLE” and, time permitting, a reason.

PHRASEOLOGY–

UNABLE (requested operation).

and when necessary,

(reason and/or additional instructions.)

d. State the words “STAND BY.”

NOTE–

“STAND BY” is not an approval or denial. The controller acknowledges the request and will respond at a later time.

REFERENCE–

*FAAO 7110.65, Traffic Advisories, Para 2–1–21
FAAO 7110.65, Route or Altitude Amendments, Para 4–2–5
FAAO 7110.65, Methods, Para 7–9–3*

2–1–19. WAKE TURBULENCE

a. Apply wake turbulence procedures to aircraft operating behind heavy jets/B757s and, where indicated, to small aircraft behind large aircraft.

NOTE–

Para 5–5–4 Minima, specifies increased radar separation for small type aircraft landing behind large, heavy, or B757 aircraft because of the possible effects of wake turbulence.

b. The separation minima shall continue to touchdown for all IFR aircraft not making a visual approach or maintaining visual separation.

REFERENCE–

FAAO 7110.65, Approach Separation Responsibility, Para 5–9–5

2–1–20. WAKE TURBULENCE CAUTIONARY ADVISORIES

a. Issue wake turbulence cautionary advisories and the position, altitude if known, and direction of flight of the heavy jet or B757 to:

REFERENCE–

AC 90–23, Aircraft Wake Turbulence, Pilot Responsibility, Para 12.

1. **TERMINAL.** VFR aircraft not being radar vectored but are behind heavy jets or B757s.

2. IFR aircraft that accept a visual approach or visual separation.

REFERENCE–

FAAO 7110.65, Visual Approach, Para 7–4–1

3. **TERMINAL.** VFR arriving aircraft that have previously been radar vectored and the vectoring has been discontinued.

b. Issue cautionary information to any aircraft if in your opinion, wake turbulence may have an adverse effect on it. When traffic is known to be a heavy aircraft, include the word *heavy* in the description.

NOTE–

Wake turbulence may be encountered by aircraft in flight as well as when operating on the airport movement area. Because wake turbulence is unpredictable, the controller is not responsible for anticipating its existence or effect. Although not mandatory during ground operations, controllers may use the words jet blast, propwash, or rotorwash, in lieu of wake turbulence, when issuing a caution advisory.

REFERENCE–

*AC 90–23, Aircraft Wake Turbulence.
P/CG Term– Aircraft Classes.
P/CG Term– Wake Turbulence.*

PHRASEOLOGY–

CAUTION WAKE TURBULENCE (traffic information).

REFERENCE–

FAAO 7110.65, Visual Separation, Para 7–2–1

2–1–21. TRAFFIC ADVISORIES

Unless an aircraft is operating within Class A airspace or omission is requested by the pilot, issue traffic advisories to all aircraft (IFR or VFR) on your frequency when, in your judgment, their proximity may diminish to less than the applicable separation minima. Where no separation minima applies, such as for VFR aircraft outside of Class B/Class C airspace, or a TRSA, issue traffic advisories to those aircraft on your frequency when in your judgment their proximity warrants it. Provide this service as follows:

a. To radar identified aircraft:

1. Azimuth from aircraft in terms of the 12-hour clock, or

2. When rapidly maneuvering aircraft prevent accurate issuance of traffic as in 1 above, specify the direction from an aircraft’s position in terms of the eight cardinal compass points (N, NE, E, SE, S, SW, W, and NW). This method shall be terminated at the pilot’s request.

3. Distance from aircraft in miles.

4. Direction in which traffic is proceeding and/or relative movement of traffic.

NOTE–

Relative movement includes closing, converging, parallel same direction, opposite direction, diverging, overtaking, crossing left to right, crossing right to left.

5. If known, type of aircraft and altitude.

REFERENCE-

FAAO 7110.65, *Description of Aircraft Types, Para 2-4-21*

PHRASEOLOGY-

TRAFFIC, (number) O’CLOCK,

or when appropriate,

(direction) (number) MILES, (direction)-BOUND and/or (relative movement),

and if known,

(type of aircraft and altitude).

or

When appropriate,

(type of aircraft and relative position), (number of feet) FEET ABOVE/BELOW YOU.

If altitude is unknown,

ALTITUDE UNKNOWN.

EXAMPLE-

“Traffic, eleven o’clock, one zero miles, southbound, converging, Boeing Seven Twenty Seven, one seven thousand.”

“Traffic, twelve o’clock, one five miles, opposite direction, altitude unknown.”

“Traffic, ten o’clock, one two miles, southeast bound, one thousand feet below you.”

6. When requested by the pilot, issue radar vectors to assist in avoiding the traffic, provided the aircraft to be vectored is within your area of jurisdiction or coordination has been effected with the sector/facility in whose area the aircraft is operating.

7. If unable to provide vector service, inform the pilot.

REFERENCE-

FAAO 7110.65, *Operational Requests, Para 2-1-18*

8. Inform the pilot of the following when traffic you have issued is not reported in sight:

- (a) The traffic is no factor.
- (b) The traffic is no longer depicted on radar.

PHRASEOLOGY-

TRAFFIC NO FACTOR/NO LONGER OBSERVED,

or

(number) O’CLOCK TRAFFIC NO FACTOR/NO LONGER OBSERVED,

or

(direction) TRAFFIC NO FACTOR/NO LONGER OBSERVED.

b. To aircraft that are not radar identified:

- 1. Distance and direction from fix.
- 2. Direction in which traffic is proceeding.
- 3. If known, type of aircraft and altitude.
- 4. ETA over the fix the aircraft is approaching, if appropriate.

PHRASEOLOGY-

TRAFFIC, (number) MILES/MINUTES (direction) OF (airport or fix), (direction)-BOUND,

and if known,

(type of aircraft and altitude),

ESTIMATED (fix) (time),

or

TRAFFIC, NUMEROUS AIRCRAFT VICINITY (location).

If altitude is unknown,

ALTITUDE UNKNOWN.

EXAMPLE-

“Traffic, one zero miles east of Forsythe V-O-R, Southbound, M-D Eighty, descending to one six thousand.”

“Traffic, reported one zero miles west of Downey V-O-R, northbound, Apache, altitude unknown, estimated Joliet V-O-Rone three one five.”

“Traffic, eight minutes west of Chicago Heights V-O-R, westbound, Mooney, eight thousand, estimated Joliet V-O-R two zero three five.”

“Traffic, numerous aircraft, vicinity of Delia airport.”

c. For aircraft displaying Mode C, not radar identified, issue indicated altitude.

EXAMPLE-

“Traffic, one o’clock, six miles, eastbound, altitude indicates six thousand five hundred.”

REFERENCE-

FAAO 7110.65, *Traffic Information, Para 3-1-6*

FAAO 7110.65, *Visual Separation, Para 7-2-1*

FAAO 7110.65, *VFR Departure Information, Para 7-6-10*

2-1-22. BIRD ACTIVITY INFORMATION

a. Issue advisory information on pilot-reported, tower-observed, or radar-observed and pilot-verified bird activity. Include position, species or size of birds, if known, course of flight, and altitude. Do this for at least 15 minutes after receipt of such information from pilots or from adjacent facilities unless visual observation or subsequent reports reveal the activity is no longer a factor.

EXAMPLE-

“Flock of geese, one o’clock, seven miles, northbound, last reported at four thousand.”

“Flock of small birds, southbound along Mohawk River, last reported at three thousand.”

“Numerous flocks of ducks, vicinity Lake Winnebago, altitude unknown.”

b. Relay bird activity information to adjacent facilities and to FSSs whenever it appears it will become a factor in their areas.

2-1-23. TRANSFER OF POSITION RESPONSIBILITY

The transfer of position responsibility shall be accomplished in accordance with the “Standard Operating Practice (SOP) for the Transfer of Position Responsibility,” and appropriate facility directives each time operational responsibility for a position is transferred from one specialist to another.

2-1-24. WHEELS DOWN CHECK

USA/USAF/USN

Remind aircraft to check wheels down on each approach unless the pilot has previously reported wheels down for that approach.

NOTE-

The intent is solely to remind the pilot to lower the wheels, not to place responsibility on the controller.

a. Tower shall issue the wheels down check at an appropriate place in the pattern.

PHRASEOLOGY-

CHECK WHEELS DOWN.

b. Approach/arrival control, GCA shall issue the wheels down check as follows:

1. To aircraft conducting ASR, PAR, or radar monitored approaches, before the aircraft starts descent on final approach.

2. To aircraft conducting instrument approaches and remaining on the radar facility’s frequency, before the aircraft passes the outer marker/final approach fix.

PHRASEOLOGY-

WHEELS SHOULD BE DOWN.

2-1-25. SUPERVISORY NOTIFICATION

Ensure supervisor/controller-in-charge (CIC) is aware of conditions which impact sector/position operations including, but not limited to, the following:

- a. Weather.
- b. Equipment status.
- c. Potential sector overload.
- d. Emergency situations.
- e. Special flights/operations.

2-1-26. PILOT DEVIATION NOTIFICATION

When it appears that the actions of a pilot constitute a pilot deviation, notify the pilot, workload permitting.

PHRASEOLOGY-

(Identification) POSSIBLE PILOT DEVIATION ADVISE YOU CONTACT (facility) AT (telephone number).

REFERENCE-

FAAO 8020.11, *Aircraft Accident and Incident Notification, Investigation, and Reporting, Pilot Deviations, Para 84.*

2-1-27. TCAS RESOLUTION ADVISORIES

a. When an aircraft under your control jurisdiction informs you that it is responding to a TCAS Resolution Advisory (RA), do not issue control instructions that are contrary to the RA procedure that a crew member has advised you that they are executing. Provide safety alerts regarding terrain or obstructions and traffic advisories for the aircraft responding to the RA and all other aircraft under your control jurisdiction, as appropriate.

b. Unless advised by other aircraft that they are also responding to a TCAS RA, do not assume that other aircraft in the proximity of the responding aircraft are involved in the RA maneuver or are aware of the responding aircraft’s intended maneuvers.

Continue to provide control instructions, safety alerts, and traffic advisories as appropriate to such aircraft.

c. Once the responding aircraft has begun a maneuver in response to an RA, the controller is not responsible for providing standard separation between the aircraft that is responding to an RA and any other aircraft, airspace, terrain or obstructions. Responsibility for standard separation resumes when one of the following conditions are met:

1. The responding aircraft has returned to its assigned altitude, or
2. A crew member informs you that the TCAS maneuver is completed and you observe that standard separation has been reestablished, or
3. The responding aircraft has executed an alternate clearance and you observe that standard separation has been reestablished.

NOTE-

1. *AC 120-55A, Air Carrier Operational Approval and Use of TCAS II, suggests pilots use the following phraseology to notify controllers during TCAS events. When a TCAS RA may affect an ATC clearance, inform ATC when beginning the maneuver, or as soon as workload permits.*

EXAMPLE-

1. "New York Center, United 321, TCAS climb."

NOTE-

2. *When the RA has been resolved, the flight crew should advise ATC they are returning to their previously assigned clearance or subsequent amended clearance.*

EXAMPLE-

2. "New York Center, United 321, clear of conflict, returning to assigned altitude."

2-1-28. RVSM OPERATIONS

Controller responsibilities shall include but not be limited to the following:

a. Non-RVSM aircraft operating in RVSM airspace.

1. Ensure non-RVSM aircraft are not permitted in RVSM airspace unless they meet the criteria of excepted aircraft and are previously approved by the operations supervisor/controller-in-charge (CIC).

The following aircraft are excepted: DOD, Life-guard, manufacturer aircraft being flown for development/certification, and Foreign State aircraft. These exceptions are accommodated on a workload or traffic-permitting basis.

NOTE-

The operations supervisor/CIC is responsible for system acceptance of a non-RVSM aircraft beyond the initial sector to sector coordination following the pilot request to access the airspace. Operations supervisor/CIC responsibilities are defined in FAA Order 7210.3, Chapter 6, Section 9, Reduced Vertical Separation Minimum (RVSM).

2. Ensure sector-to-sector coordination for all non-RVSM aircraft operations within RVSM airspace.

b. Non-RVSM aircraft transitioning RVSM airspace.

Ensure that operations supervisors/CICs are made aware when non-RVSM aircraft are transitioning through RVSM airspace.

c. Apply appropriate separation standards and remove any aircraft from RVSM airspace that advises it is unable RVSM due to equipment while en route.

d. Use "negative RVSM" in all verbal ground-to-ground communications involving non-RVSM aircraft while cleared to operate within RVSM airspace.

EXAMPLE-

"Point out Baxter21 climbing to FL 360, negative RVSM."

e. For the following situations, use the associated phraseology:

1. To deny clearance into RVSM airspace.

PHRASEOLOGY-

"UNABLE CLEARANCE INTO RVSM AIRSPACE."

2. To request a pilot to report when able to resume RVSM.

PHRASEOLOGY-

"REPORT ABLE TO RESUME RVSM."

f. In the event of a change to an aircraft's navigational capability amend the equipment suffix in order to properly identify non-RVSM aircraft on the controller display.

Section 2. Flight Plans and Control Information

2-2-1. RECORDING INFORMATION

a. Record flight plan information required by the type of flight plan and existing circumstances. Use authorized abbreviations when possible.

NOTE-

Generally, all military overseas flights are required to clear through a specified military base operations office (BASOPS). Pilots normally will not file flight plans directly with an FAA facility unless a BASOPS is not available. BASOPS will, in turn, forward the IFR flight notification message to the appropriate center.

b. **EN ROUTE.** When flight plans are filed directly with the center, record all items given by the pilot either on a flight progress strip/flight data entry or on a voice recorder. If the latter, enter in box 26 of the initial flight progress strip the sector or position number to identify where the information may be found in the event search and rescue (SAR) activities become necessary.

REFERENCE-

FAAO 7110.65, En Route Data Entries, Para 2-3-2

2-2-2. FORWARDING INFORMATION

a. Except during EAS FDP operation, forward the flight plan information to the appropriate ATC facility, FSS, or BASOPS and record the time of filing and delivery on the form.

b. **EN ROUTE.** During EAS FDP operation, the above manual actions are required in cases where the data is not forwarded automatically by the computer.

NOTE-

During EAS FDP operation, data is exchanged between interfaced automated facilities and both the data and time of transmission are recorded automatically.

c. **EN ROUTE.** Forward proposed tower en route flight plans and any related amendments to the appropriate departure terminal facility.

2-2-3. FORWARDING VFR DATA

TERMINAL

Forward aircraft departure times to FSSs or military operations offices when they have requested them. Forward other VFR flight plan data only if requested by the pilot.

2-2-4. MILITARY DVFR DEPARTURES

TERMINAL

Forward departure times on all military DVFR departures from joint-use airports to the military operations office.

NOTE-

1. Details for handling air carrier, nonscheduled civil, and military DVFR flight data are contained in FAAO 7610.4, Special Military Operations.

2. Military pilots departing DVFR from a joint-use airport will include the phrase "DVFR to (destination)" in their initial call-up to an FAA operated tower.

2-2-5. IFR TO VFR FLIGHT PLAN CHANGE

Request a pilot to contact the appropriate FSS if the pilot informs you of a desire to change from an IFR to a VFR flight plan.

2-2-6. IFR FLIGHT PROGRESS DATA

Forward control information from controller to controller within a facility, then to the receiving facility as the aircraft progresses along its route. Where appropriate, use computer equipment in lieu of manual coordination procedures. Do not use the remarks section of flight progress strips in lieu of voice coordination to pass control information. Ensure that flight plan and control information is correct and up-to-date. When covered by a letter of agreement/facility directive, the time requirements of subpara a may be reduced, and the time requirements of subpara b1 and para 2-2-11, Forwarding Amended and UTM Data, subpara a may be increased up to 15 minutes when facilitated by automated systems or mandatory radar handoffs; or if operationally necessary because of manual data processing or nonradar operations, the time requirements of subpara a may be increased.

NOTE-

1. The procedures for preparing flight plan and control information related to altitude reservations (ALTRVs) are contained in FAAO 7210.3, Facility Operation and Administration, para 8-1-2, ALTRV Flight Data Processing. Development of the methods for assuring the accuracy and completeness of ALTRV flight plan and control information is the responsibility of the military liaison and security officer.

2. The term facility in this paragraph refers to centers and terminal facilities when operating in an en route capacity.

a. Forward the following information at least 15 minutes before the aircraft is estimated to enter the receiving facility's area:

1. Aircraft identification.
2. Number of aircraft if more than one, heavy aircraft indicator "H/" if appropriate, type of aircraft, and aircraft equipment suffix.
3. Assigned altitude and ETA over last reporting point/fix in transferring facility's area or assumed departure time when the departure point is the last point/fix in the transferring facility's area.
4. Altitude at which aircraft will enter the receiving facility's area if other than the assigned altitude.
5. True airspeed.
6. Point of departure.
7. Route of flight remaining.
8. Destination airport and clearance limit if other than destination airport.
9. ETA at destination airport (not required for military or scheduled air carrier aircraft).
10. Altitude requested by the aircraft if assigned altitude differs from requested altitude (within a facility only).

NOTE-

When an aircraft has crossed one facility's area and assignment at a different altitude is still desired, the pilot will reinitiate the request with the next facility.

REFERENCE-

FAAO 7110.65, Anticipated Altitude Changes, Para 4-5-8

11. When flight plan data must be forwarded manually and an aircraft has been assigned a beacon code by the computer, include the code as part of the flight plan.

NOTE-

When an IFR aircraft, or a VFR aircraft that has been assigned a beacon code by the EAS and whose flight plan will terminate in another facility's area, cancels ATC service or does not activate the flight plan, send a remove strips (RS) message on that aircraft via the EAS keyboard, the FDIO keyboard or call via service F.

12. Longitudinal separation being used between aircraft at the same altitude if it results in these aircraft

having less than 10 minutes separation at the facilities' boundary.

13. Any additional nonroutine operational information pertinent to flight safety.

NOTE-

EN ROUTE. This includes alerting the receiving controller that the flight is conducting celestial navigation training.

REFERENCE-

FAAO 7110.65, Celestial Navigation Training, Para 9-3-2

b. Forward position report over last reporting point in the transferring facility's area if any of the following conditions exist:

1. Time differs more than 3 minutes from estimate given.
2. Requested by receiving facility.
3. Agreed to between facilities.

2-2-7. MANUAL INPUT OF COMPUTER-ASSIGNED BEACON CODES

When a flight plan is manually entered into the computer and a computer-assigned beacon code has been forwarded with the flight plan data, insert the beacon code in the appropriate field as part of the input message.

2-2-8. ALTRV INFORMATION

EN ROUTE

When an aircraft is a part of an approved ALTRV, forward only those items necessary to properly identify the flight, update flight data contained in the ALTRV APVL, or revise previously given information.

2-2-9. COMPUTER MESSAGE VERIFICATION

EN ROUTE

Unless your facility is equipped to automatically obtain acknowledgment of receipt of transferred data, when you transfer control information by computer message, obtain, via Service F, acknowledgment that the receiving center has received the message and verification of the following:

a. Within the time limits specified by a letter of agreement or when not covered by a letter of agreement, at least 15 minutes before the aircraft is estimated to enter the receiving facility's area, or at

the time of a radar handoff, or coordination for transfer of control:

1. Aircraft identification.
2. Assigned altitude.
3. Departure or coordination fix time.

b. Any cancellation of IFR or EAS generated VFR flight plan.

REFERENCE–

FAAO 7110.65, *IFR Flight Progress Data, Para 2–2–6*

2–2–10. TRANSMIT PROPOSED FLIGHT PLAN

EN ROUTE

a. Transmit proposed flight plans which fall within an ARTCC's Proposed Boundary Crossing Time (PBCT) parameter to adjacent ARTCC's via the Computer B network during hours of inter-center computer operation. In addition, when the route of flight of any proposed flight plan exceeds 20 elements external to the originating ARTCC's area, NADIN shall be used to forward the data to all affected centers.

b. During nonautomated operation, the proposed flight plans shall be sent via NADIN to the other centers involved when any of the following conditions are met:

1. The route of flight external to the originating center's area consists of 10 or more elements and the flight will enter 3 or more other center areas.

NOTE–

An element is defined as either a fix or route as specified in FAAO 7110.10, Flight Services, para 6–3–3, IFR Flight Plan Control Messages.

2. The route of flight beyond the first point of exit from the originating center's area consists of 10 or more elements, which are primarily fixes described in fix-radial-distance or latitude/longitude format, regardless of the number of other center areas entered.

3. The flight plan remarks are too lengthy for interphone transmission.

2–2–11. FORWARDING AMENDED AND UTM DATA

a. Forward any amending data concerning previously forwarded flight plans except that revisions to ETA information in para 2–2–6, IFR Flight Progress Data, need only be forwarded when the time differs by more than 3 minutes from the estimate given.

PHRASEOLOGY–

(Identification), REVISED (revised information).

EXAMPLE–

“American Two, revised flight level, three three zero.”

“United Eight Ten, revised estimate, Front Royal two zero zero five.”

“Douglas Five Zero One Romeo, revised altitude, eight thousand.”

“U.S. Air Eleven Fifty–one, revised type, heavy Boeing Seven Sixty–seven.”

REFERENCE–

FAAO 7110.65, *IFR Flight Progress Data, Para 2–2–6*

b. Computer acceptance of an appropriate input message fulfills the requirement for sending amended data. During EAS FDP operations, the amendment data are considered acknowledged on receipt of a computer update message or a computer-generated flight progress strip containing the amended data.

NOTE–

1. The successful utilization of automation equipment requires timely and accurate insertion of changes and/or new data.

2. If a pilot is not issued a computer-generated PDR/PDAR/PAR and if amendment data is not entered into the computer, the next controller will have incorrect route information.

c. Forward any amended control information and record the action on the appropriate flight progress strip. Additionally, when a route or altitude in a previously issued clearance is amended within 15 minutes of an aircraft's proposed departure time, the facility that amended the clearance shall coordinate the amendment with the receiving facility via verbal AND automated means to ensure timely passage of the information.

NOTE–

The term “receiving” facility means the ATC facility that is expected to transmit the amended clearance to the intended aircraft/pilot.

d. EN ROUTE. Effect manual coordination on any interfacility flight plan data that is not passed through automated means.

2-2-12. AIRBORNE MILITARY FLIGHTS

Forward to FSSs the following information received from airborne military aircraft:

a. IFR flight plans and changes from VFR to IFR flight plans.

b. Changes to an IFR flight plan as follows:

1. Change in destination:

(a) Aircraft identification and type.

(b) Departure point.

(c) Original destination.

(d) Position and time.

(e) New destination.

(f) ETA.

(g) Remarks including change in fuel exhaustion time.

(h) Revised ETA.

2. Change in fuel exhaustion time.

NOTE-

This makes current information available to FSSs for relay to military bases concerned and for use by centers in the event of two-way radio communications failure.

2-2-13. FORWARDING FLIGHT PLAN DATA BETWEEN U.S. ARTCCs AND CANADIAN ACCs

EN ROUTE

a. Domestic. (Continental U.S./Canadian airspace except Alaska) Proposed departure flight plans and en route estimates will be handled on a 30 minute lead time (or as bilaterally agreed) between any ACC and ARTCC.

b. International. Any route changes (except DPs) must be forwarded to the appropriate Oceanic/Pre-oceanic ACC or ARTCC with an optimum lead time of 30 minutes or as soon as this information becomes available.

c. Initially, if a flight goes from U.S. airspace into Canadian airspace and returns to U.S. airspace, the ACC will be responsible for forwarding the flight plan data to the appropriate ARTCC by voice

transmission except for flights which traverse mutually agreed on airways/fixes. These airways/fixes will be determined on a case-by-case basis and will be based on time and distance considerations at the regional level.

2-2-14. TELETYPE FLIGHT DATA FORMAT- U.S. ARTCCs - CANADIAN ACCs

EN ROUTE

The exchange of flight plan data between Canadian ACCs and U.S. ARTCCs shall be made as follows:

a. The U.S. ARTCCs will transmit flight data to the Canadian ACCs in one of the following formats:

1. NADIN II input format as described in the NAS Management Directives (MDs) for:

(a) Flight Plan Messages:

(1) Active.

(2) Proposed.

(b) Amendment messages.

(c) Cancellation messages.

(d) Response Messages to Canadian Input:

(1) Acknowledgment messages.

(2) Error messages.

(3) Rejection messages.

2. Transport Canada (TC) ACC Flight Strip Format: Where the data to be printed on the ACC strip form exceeds the strip form field size, the NADIN II input format in 1 above will be used. Input sequentially fields 1 through 8 in para 2-2-6, IFR Flight Progress Data, subpara a.

b. TC's ACCs will transmit flight data to the FAA ARTCCs in the following format:

1. NADIN II input format as described in NAS MDs for:

(a) Flight Plan Messages:

(1) Active.

(2) Proposed.

(b) Amendment messages.

(c) Cancellation messages.

(d) Correction messages.

2-2-15. NORTH AMERICAN ROUTE PROGRAM (NRP) INFORMATION

a. “NRP” shall be retained in the remarks section of the flight plan if the aircraft is moved due to weather, traffic, or other tactical reasons.

NOTE-

Every effort should be made to ensure the aircraft is returned to the original filed flight plan/altitude as soon as conditions warrant.

b. If the route of flight is altered due to a pilot request, “NRP” shall be removed from the remarks section of the flight plan.

c. “NRP” shall not be entered in the remarks section of a flight plan, unless prior coordination is accomplished with the ATCSCC or as prescribed by international NRP flight operations procedures.

d. The en route facility within which an international flight entering the conterminous U.S. requests to participate in the NRP shall enter “NRP” in the remarks section of the flight plan.

REFERENCE-

FAAO 7110.65, Operational Priority, Para 2-1-4

FAAO 7110.65, En Route Data Entries, Para 2-3-2

FAAO 7110.65, Route or Altitude Amendments, Para 4-2-5

FAAO 7210.3, Chapter 17, Section 14, North American Route Program. ■

Section 3. Flight Progress Strips

2-3-1. GENERAL

Unless otherwise authorized in a facility directive, use flight progress strips to post current data on air traffic and clearances required for control and other air traffic control services. To prevent misinterpretation when data is hand printed, use standard hand-printed characters.

En route: Flight progress strips shall be posted.

REFERENCE-

FAAO 7210.3, *Flight Progress Strip Usage, Para 6-1-6.*

a. Maintain only necessary current data and remove the strips from the flight progress boards when no longer required for control purposes. To correct, update, or preplan information:

1. Do not erase or overwrite any item. Use an "X" to delete a climb/descend and maintain arrow, an at or above/below symbol, a cruise symbol, and unwanted altitude information. Write the new altitude information immediately adjacent to it and within the same space.

2. Do not draw a horizontal line through an altitude being vacated until after the aircraft has

reported or is observed (valid Mode C) leaving the altitude.

3. Preplanning may be accomplished in red pencil.

b. Manually prepared strips shall conform to the format of machine-generated strips and manual strip preparation procedures will be modified simultaneously with the operational implementation of changes in the machine-generated format. (See FIG 2-3-1.)

c. Altitude information may be written in thousands of feet provided the procedure is authorized by the facility manager, and is defined in a facility directive, i.e. 5,000 feet as 5, and 2,800 as 2.8.

NOTE-

A slant line crossing through the number zero and underline of the letter "s" on handwritten portions of flight progress strips are required only when there is reason to believe the lack of these markings could lead to misunderstanding. A slant line crossing through the number zero is required on all weather data.

FIG 2-3-1
Standard Recording of Hand-printed Characters

Typed	Hand Printed	Typed	Hand Printed
A	A	T	T
B	B	U	U
C	C	V	V
D	D	W	W
E	E	X	X
F	F	Y	Y
G	G	Z	Z
H	H		
I	I	1	1
J	J	2	2
K	K	3	3
L	L	4	4
M	M	5	5
N	N	6	6
O	O	7	7
P	P	8	8
Q	Q	9	9
R	R	0	Ø
S	S		

2-3-2. EN ROUTE DATA ENTRIES

FIG 2-3-2
Flight Progress Strip
(7230-19)

3	1	2	11	15	16	20	21	25	27	28
4			12				22			
5			13							
6			14				23			
7	8			17	18					
	9			19		20a	24	26	29	30
DAL542			1	7HQ	18	30	330	FLLJ14 ENO 000212	2675	
H/B753/A				1827				COD PHL		
T468 G555										
16 16										
486 09				PXT		RA ↑1828			*ZCN	

a. Information recorded on the flight progress strips (FAA Forms 7230-19) shall be entered in the correspondingly numbered spaces:

TBL 2-3-1

Block	Information Recorded
1.	Verification symbol if required.
2.	Revision number. DSR-Not used.
3.	Aircraft identification.
4.	Number of aircraft if more than one, heavy aircraft indicator "H/" if appropriate, type of aircraft, and aircraft equipment suffix.
5.	Filed true airspeed.
6.	Sector number.
7.	Computer identification number if required.
8.	Estimated ground speed.
9.	Revised ground speed or strip request (SR) originator.
10.	Strip number. DSR- Strip number/Revision number.
11.	Previous fix.
12.	Estimated time over previous fix.
13.	Revised estimated time over previous fix.

Block	Information Recorded
14.	Actual time over previous fix, or actual departure time entered on first fix posting after departure.
14a.	Plus time expressed in minutes from the previous fix to the posted fix.
15.	Center-estimated time over fix (in hours and minutes), or clearance information for departing aircraft.
16.	Arrows to indicate if aircraft is departing (↑) or arriving (↓).
17.	Pilot-estimated time over fix.
18.	Actual time over fix, time leaving holding fix, arrival time at nonapproach control airport, or symbol indicating cancellation of IFR flight plan for arriving aircraft, or departure time (actual or assumed).
19.	Fix. For departing aircraft, add proposed departure time.
20.	Altitude information (in hundreds of feet) or as noted below.
NOTE-	<i>Altitude information may be written in thousands of feet provided the procedure is authorized by the facility manager, and is defined in a facility directive, i.e. FL 330 as 33, 5,000 feet as 5, and 2,800 as 2.8.</i>

Block	Information Recorded
20a.	OPTIONAL USE , when voice recorders are operational; REQUIRED USE , when the voice recorders are not operating and strips are being use at the facility. This space is used to record reported RA events. The letters RA followed by a climb or descent arrow (if the climb or descent action is reported) and the time (hhmm) the event is reported.
21.	Next posted fix or coordination fix.
22.	Pilot's estimated time over next fix.
23.	Arrows to indicate north (↑), south (↓), east (→), or west (←) direction of flight if required.
24.	Requested altitude.
NOTE-	<i>Altitude information may be written in thousands of feet provided the procedure is authorized by the facility manager, and is defined in a facility directive, i.e., FL 330 as 33, 5,000 feet as 5, and 2,800 as 2.8.</i>
25.	Point of origin, route as required for control and data relay, and destination.

Block	Information Recorded
26.	Pertinent remarks, minimum fuel, point out/radar vector/speed adjustment information or sector/position number (when applicable in accordance with para 2-2-1, Recording Information), or NRP. High Altitude Redesign (HAR) or Point-to-point (PTP) may be used at facilities actively using these programs.
27.	Mode 3/A beacon code if applicable.
28.	Miscellaneous control data (expected further clearance time, time cleared for approach, etc.).
29-30.	Transfer of control data and coordination indicators.

b. Latitude/longitude coordinates may be used to define waypoints and may be substituted for nonadapted NAVAIDs in space 25 of domestic en route flight progress strips provided it is necessary to accommodate a random RNAV or GNSS route request.

c. Facility Air Traffic managers may authorize the optional use of spaces 13, 14, 14a, 22, 23, 24, and 28 for point out information, radar vector information, speed adjustment information, or transfer of control data.

2-3-3. TERMINAL DATA ENTRIES

a. Arrivals:

Information recorded on the flight progress strips (FAA Forms 7230-7.1, 7230-7.2, and 7230-8) shall be entered in the correspondingly numbered spaces. Facility managers can authorize omissions and/or optional use of spaces 2A, 8A, 8B, 9A, 9B, 9C, and 10-18, if no misunderstanding will result. These omissions and/or optional uses shall be specified in a facility directive.

FIG 2-3-3

1	2A	5	8	9	9B	10	11	12
2		6	8A			13	14	15
3		7	8B	9A	9C	16	17	18
4								

TBL 2-3-2

Block	Information Recorded
1.	Aircraft identification.
2.	Revision number (FDIO locations only).
2A.	Strip request originator. (At FDIO locations this indicates the sector or position that requested a strip be printed.)
3.	Number of aircraft if more than one, heavy aircraft indicator "H" if appropriate, type of aircraft, and aircraft equipment suffix.
4.	Computer identification number if required.
5.	Secondary radar (beacon) code assigned.
6.	(FDIO Locations.) The previous fix will be printed. (Non-FDIO Locations.) Use of the inbound airway. This function is restricted to facilities where flight data is received via interphone when agreed upon by the center and terminal facilities.
7.	Coordination fix.
8.	Estimated time of arrival at the coordination fix or destination airport.
8A.	OPTIONAL USE.

Block	Information Recorded
8B.	OPTIONAL USE , when voice recorders are operational; REQUIRED USE , when the voice recorders are not operating and strips are being used at the facility. This space is used to record reported RA events when the voice recorders are not operational and strips are being used at the facility. The letters RA followed by a climb or descent arrow (if the climb or descent action is reported) and the time (hhmm) the event is reported.
9.	Altitude (in hundreds of feet) and remarks.
NOTE-	<i>Altitude information may be written in thousands of feet provided the procedure is authorized by the facility manager, and is defined in a facility directive, i. e., FL 230 as 23, 5,000 feet as 5, and 2,800 as 2.8.</i>
9A.	Minimum fuel, destination airport/point out/radar vector/speed adjustment information. Air Traffic managers may authorize in a facility directive the omission of any of these items, except minimum fuel , if no misunderstanding will result.
NOTE-	<i>Authorized omissions and optional use of spaces shall be specified in the facility directive concerning strip marking procedures.</i>
9B.	OPTIONAL USE.
9C.	OPTIONAL USE.
10-18.	Enter data as specified by a facility directive. Radar facility personnel need not enter data in these spaces except when nonradar procedures are used or when radio recording equipment is inoperative.

b. Departures:

Information recorded on the flight progress strips (FAA Forms 7230-7.1, 7230-7.2, and 7230-8) shall be entered in the correspondingly numbered spaces. Facility managers can authorize omissions and/or optional use of spaces 2A, 8A, 8B, 9A, 9B, 9C, and 10-18, if no misunderstanding will result. These omissions and/or optional uses shall be specified in a facility directive.

FIG 2-3-4

1	2A	5	8	9	9B	10	11	12		
2		6	8A			13	14	15		
3		7	8B			9A	9C	16	17	18
4										

TBL 2-3-3

Block	Information Recorded
1.	Aircraft identification.
2.	Revision number (FDIO locations only).
2A.	Strip request originator. (At FDIO locations this indicates the sector or position that requested a strip be printed.)
3.	Number of aircraft if more than one, heavy aircraft indicator "H/" if appropriate, type of aircraft, and aircraft equipment suffix.
4.	Computer identification number if required.
5.	Secondary radar (beacon) code assigned.
6.	Proposed departure time.
7.	Requested altitude.
NOTE-	<i>Altitude information may be written in thousands of feet provided the procedure is authorized by the facility manager, and is defined in a facility directive, i. e., FL 230 as 23, 5,000 feet as 5, and 2,800 as 2.8.</i>
8.	Departure airport.
8A.	OPTIONAL USE.

Block	Information Recorded
8B.	OPTIONAL USE , when voice recorders are operational; REQUIRED USE , when the voice recorders are not operating and strips are being used at the facility. This space is used to record reported RA events when the voice recorders are not operational and strips are being used at the facility. The letters RA followed by a climb or descent arrow (if the climb or descent action is reported) and the time (hhmm) the event is reported.
9.	Computer-generated: Route, destination, and remarks. Manually enter altitude/altitude restrictions in the order flown, if appropriate, and remarks.
9.	Hand-prepared: Clearance limit, route, altitude/altitude restrictions in the order flown, if appropriate, and remarks.
NOTE-	<i>Altitude information may be written in thousands of feet provided the procedure is authorized by the facility manager, and is defined in a facility directive, i.e., FL 230 as 23, 5,000 feet as 5, and 2,800 as 2.8.</i>
9A.	OPTIONAL USE.
9B.	OPTIONAL USE.
9C.	OPTIONAL USE.
10-18.	Enter data as specified by a facility directive. Items, such as departure time, runway used for takeoff, check marks to indicate information forwarded or relayed, may be entered in these spaces.

c. Overflights:

Information recorded on the flight progress strips (FAA Forms 7230-7.1, 7230-7.2, and 7230-8) shall be entered in the correspondingly numbered spaces. Facility managers can authorize omissions and/or optional use of spaces 2A, 8A, 8B, 9A, 9B, 9C, and 10-18, if no misunderstanding will result. These omissions and/or optional uses shall be specified in a facility directive.

FIG 2-3-5

1	2A	5	8	9	9B	10	11	12		
2		6	8A			13	14	15		
3		7	8B			9A	9C	16	17	18
4										

TBL 2-3-4

Block	Information Recorded
1.	Aircraft identification.
2.	Revision number (FDIO locations only).
2A.	Strip request originator. (At FDIO locations this indicates the sector or position that requested a strip be printed.)
3.	Number of aircraft if more than one, heavy aircraft indicator "H/" if appropriate, type of aircraft, and aircraft equipment suffix.
4.	Computer identification number if required.
5.	Secondary radar (beacon) code assigned.
6.	Coordination fix.
7.	Overflight coordination indicator (FDIO locations only).
NOTE-	<i>The overflight coordination indicator identifies the facility to which flight data has been forwarded.</i>
8.	Estimated time of arrival at the coordination fix.
8A.	OPTIONAL USE.

Block	Information Recorded
8B.	OPTIONAL USE , when voice recorders are operational; REQUIRED USE , when the voice recorders are not operating and strips are being used at the facility. This space is used to record reported RA events when the voice recorders are not operational and strips are being used at the facility. The letters RA followed by a climb or descent arrow (if the climb or descent action is reported) and the time (hhmm) the event is reported.
9.	Altitude and route of flight through the terminal area.
NOTE-	<i>Altitude information may be written in thousands of feet provided the procedure is authorized by the facility manager, and is defined in a facility directive, i.e., FL 230 as 23, 5,000 feet as 5, and 2,800 as 2.8.</i>
9A.	OPTIONAL USE.
9B.	OPTIONAL USE.
9C.	OPTIONAL USE.
10-18.	Enter data as specified by a facility directive.

NOTE-
National standardization of items (10 through 18) is not practical because of regional and local variations in operating methods; e.g., single fix, multiple fix, radar, tower en route control, etc.

d. Air traffic managers at automated terminal radar facilities may waive the requirement to use flight progress strips provided:

1. Backup systems such as multiple radar sites/systems or single site radars with CENRAP are utilized.

2. Local procedures are documented in a facility directive. These procedures should include but not be limited to:

- (a) Departure areas and/or procedures.
- (b) Arrival procedures.
- (c) Overflight handling procedures.
- (d) Transition from radar to nonradar.
- (e) Transition from ARTS to non-ARTS.
- (f) Transition from ASR to CENRAP.
- (g) Transition to or from ESL.

3. No misunderstanding will occur as a result of no strip usage.

4. Unused flight progress strips, facility developed forms and/or blank notepads shall be provided for controller use.

5. Facilities shall revert to flight progress strip usage if backup systems referred to in subpara d1 are not available.

e. Air traffic managers at FDIO locations may authorize reduced lateral spacing between fields so as to print all FDIO data to the left of the strip perforation. When using FAA Form 7230-7.2, all items will retain the same relationship to each other as they do when the full length strip (FAA Form 7230-7.1) is used.

2-3-4. AIRCRAFT IDENTITY

Indicate aircraft identity by one of the following using combinations not to exceed seven alphanumeric characters:

a. Civil aircraft, including air-carrier aircraft letter-digit registration number including the letter “T” prefix for air taxi aircraft, the letter “L” for lifeguard aircraft, 3-letter aircraft company designator specified in FAAO 7340.1, Contractions, followed by the trip or flight number. Use the operating air carrier’s company name in identifying equipment interchange flights.

EXAMPLE-
 “N12345.”
 “TN5552Q.”
 “AA1192.”
 “LN751B.”

NOTE-
 The letter “L” is not to be used for air carrier/air taxi lifeguard aircraft.

b. Military Aircraft.

1. Prefixes indicating branch of service and/or type of mission followed by the last 5 digits of the serial number (the last 4 digits for CAF/CAM/CTG). (See TBL 2-3-5 and TBL 2-3-6.)

2. Pronounceable words of 3, 4, 5, and 6 letters followed by a 4-, 3-, 2-, or 1-digit number.

EXAMPLE-
 “SAMP Three One Six.”

3. Assigned double-letter 2-digit flight number.

4. Navy or Marine fleet and training command aircraft, one of the following:

(a) The service prefix and 2 letters (use phonetic alphabet equivalent) followed by 2 or 3 digits.

**TBL 2-3-5
 Branch of Service Prefix**

Prefix	Branch
A	U.S. Air Force
C	U.S. Coast Guard
G	Air or Army National Guard
R	U.S. Army
VM	U.S. Marine Corps
VV	U.S. Navy
CAF	Canadian Armed Force
CAM	Canadian Armed Force (Transport Command)
CTG	Canadian Coast Guard

**TBL 2-3-6
 Military Mission Prefix**

Prefix	Mission
E	Medical Air Evacuation
F	Flight Check
L	LOGAIR (USAF Contract)
RCH	AMC (Air Mobility Command)
S	Special Air Mission

(b) The service prefix and a digit and a letter (use phonetic alphabet equivalent) followed by 2 or 3 digits.

- c. Special-use. Approved special-use identifiers.

2-3-5. AIRCRAFT TYPE

Use the approved codes listed in Appendices A through C to indicate aircraft type.

2-3-6. USAF/USN UNDERGRADUATE PILOTS

To identify aircraft piloted by solo USAF/USN undergraduate student pilots (who may occasionally request revised clearances because they normally are restricted to flight in VFR conditions), the aircraft identification in the flight plan shall include the letter “Z” as a suffix. Do not use this suffix, however, in ground-to-air communication.

NOTE-

USAF solo students who have passed an instrument certification check may penetrate cloud layers in climb or descent only. Requests for revised clearances to avoid clouds in level flight can still be expected. This does not change the requirement to use the letter “Z” as a suffix to the aircraft identification.

REFERENCE-

*FAAO 7110.65, Aircraft Identification, Para 2-4-20
FAAO 7610.4, Chapter 12, Section 10, USAF Undergraduate Flying Training (UFT)/Pilot Instructor Training (PIT).*

2-3-7. AIRCRAFT EQUIPMENT SUFFIX

a. Indicate, for both VFR and IFR operations, the aircraft’s radar transponder, DME, or navigation capability by adding the appropriate symbol, preceded by a slant. (See TBL 2-3-7.)

b. When forwarding this information, state the aircraft type followed by the word “slant” and the appropriate phonetic letter equivalent of the suffix.

EXAMPLE-

“Cessna Three-ten slant Tango.”

“A-Ten slant November.”

“F-Sixteen slant Papa.”

“Seven-sixty-seven slant Golf.”

2-3-8. CLEARANCE STATUS

Use an appropriate clearance symbol followed by a dash (-) and other pertinent information to clearly show the clearance status of an aircraft. To indicate delay status use:

a. The symbol “H” at the clearance limit when holding instructions have been included in the aircraft’s original clearance. Show detailed holding information following the dash when holding differs from the established pattern for the fix; i.e., turns, leg lengths, etc.

b. The symbols “F” or “O” to indicate the clearance limit when a delay is not anticipated.

2-3-9. CONTROL SYMBOLOGY

Use authorized control and clearance symbols or abbreviations for recording clearances, reports, and instructions. Control status of aircraft must always be current. You may use:

a. Plain language markings when it will aid in understanding information.

b. Locally approved identifiers. Use these only within your facility and not on teletypewriter or interphone circuits.

c. Plain sheets of paper or locally prepared forms to record information when flight progress strips are not used. (See TBL 2-3-8 and TBL 2-3-9.)

d. Control Information Symbols.
(See FIG 2-3-6 and FIG 2-3-7.)

REFERENCE-

FAAO 7110.65, Exceptions, Para 4-5-3

TBL 2-3-7
Aircraft Equipment Suffixes

Suffix	Aircraft Equipment Suffixes
	NO DME
/X	No transponder
/T	Transponder with no Mode C
/U	Transponder with Mode C
	DME
/D	No transponder
/B	Transponder with no Mode C
/A	Transponder with Mode C
	TACAN ONLY
/M	No transponder
/N	Transponder with no Mode C
/P	Transponder with Mode C
	AREA NAVIGATION (RNAV)
/Y	LORAN, VOR/DME, or INS with no transponder
/C	LORAN, VOR/DME, or INS, transponder with no Mode C
/I	LORAN, VOR/DME, or INS, transponder with Mode C
	ADVANCED RNAV WITH TRANSPONDER AND MODE C (If an aircraft is unable to operate with a transponder and/or Mode C, it will revert to the appropriate code listed above under Area Navigation.)
/E	Flight Management System (FMS) with DME/DME and IRU position updating
/F	Flight Management System (FMS) with DME/DME position updating
/G	Global Navigation Satellite System (GNSS), including GPS or WAAS, with en route and terminal capability
/R	Required Navigational Performance. The aircraft meets the RNP type prescribed for the route segment(s), route(s) and/or area concerned.
	REDUCED VERTICAL SEPARATION MINIMUM (RVSM). Prior to conducting RVSM operations within the U.S., the operator must obtain authorization from the FAA or from the responsible authority, as appropriate.
/J	/E with RVSM
/K	/F with RVSM
/L	/G with RVSM
/Q	/R with RVSM
/W	RVSM

TBL 2-3-8

Clearance Abbreviations

Abbreviation	Meaning
A	Cleared to airport (point of intended landing)
B	Center clearance delivered
C	ATC clears (when clearance relayed through non-ATC facility)
CAF	Cleared as filed
D	Cleared to depart from the fix
F	Cleared to the fix
H	Cleared to hold and instructions issued
L	Cleared to land
N	Clearance not delivered
O	Cleared to the outer marker
PD	Cleared to climb/descend at pilot's discretion
Q	Cleared to fly specified sectors of a NAVAID defined in terms of courses, bearings, radials or quadrants within a designated radius.
T	Cleared through (for landing and takeoff through intermediate point)
V	Cleared over the fix
X	Cleared to cross (airway, route, radial) at (point)
Z	Tower jurisdiction

TBL 2-3-9

Miscellaneous Abbreviations

Abbreviation	Meaning
BC	Back course approach
CT	Contact approach
FA	Final approach
FMS	Flight management system approach
GPS	GPS approach
I	Initial approach
ILS	ILS approach
MA	Missed approach
MLS	MLS approach
NDB	Nondirectional radio beacon approach
OTP	VFR conditions-on-top
PA	Precision approach
PT	Procedure turn
RA	Resolution advisory (Pilot reported TCAS event)
RH	Runway heading
RNAV	Area navigation approach
RP	Report immediately upon passing (fix/altitude)
RX	Report crossing
SA	Surveillance approach
SI	Straight-in approach
TA	TACAN approach
TL	Turn left
TR	Turn right
VA	Visual approach
VR	VOR approach

FIG 2-3-6
Control Information Symbols [Part 1]

Symbols	Meaning
T→ ()	Depart (direction, if specified)
↑	Climb and maintain
↓	Descend and maintain
→	Cruise
@	At
X	Cross
-M→	Maintain
≡	Join or intercept airway/jet route/track or course
=	While in controlled airspace
△	While in control area
↗△	Enter control area
△↘	Out of control area
	Cleared to enter, depart or through surface area. Indicated direction of flight by arrow and appropriate compass letter. Maintain Special VFR conditions (altitude if appropriate) while in surface area.
250 K	Aircraft requested to adjust speed to 250 knots.
-20 K	Aircraft requested to reduce speed 20 knots.
+30 K	Aircraft requested to increase speed 30 knots.
(W)	Local Special VFR operations in the vicinity of (name) airport are authorized until(time). Maintain special VFR conditions (altitude if appropriate).
>	Before
<	After or Past
<u>170</u> (red)	Inappropriate altitude/flight level for direction of flight. (Underline assigned altitude/flight level in red).
/	Until
()	Alternate instructions
Restriction	Restriction
↓	At or Below
↑	At or Above
-(Dash)	From-to (route, time, etc.)
(Alt)B(Alt)	Indicates a block altitude assignment. Altitudes are inclusive, and the first altitude shall be lower than the second. Example: 310B370
v <	Clearance void if aircraft not off ground by (time)
NOTE: The absence of an airway route number between two fixes in the route of flight indicates "direct"; no symbol or abbreviation is required.	

FIG 2-3-7

Control Information Symbols [Part 2]

Symbols	Meaning
☒	Pilot canceled flight plan
✓	EN ROUTE: Aircraft has reported at assigned altitude, Example: 80 ✓
✓	TERMINAL/FSS: Information forwarded (indicated information forwarded as required)
○ (red)	EN ROUTE: Information or revised information forwarded. (Circle, in red, inappropriate altitude/flight level for direction of flight or other control information when coordinated. Also circle, in red, the time (minutes and altitude) when a flight plan or estimate is forwarded. Use method in both inter-center and intra-center coordination.)
⑤0	Other than assigned altitude reported (circle reported altitude)
H 10 6	DME holding (use with mileages)(Upper figure indicates distance from station to DME fix, lower figure indicates length of holding pattern.) In this example, the DME fix is 10 miles out with a 6 mile pattern indicated.
(mi.)(dir.)	DME arc of VORTAC, TACAN, or MLS.
Ⓒ (freq.)	Contact (facility) or (freq.), (time, fix, or altitude if appropriate). Insert frequency only when it is other than standard.
R	Radar contact.
R	EN ROUTE: Requested altitude (preceding altitude information)
R	Radar service terminated
R	Radar contact lost
RV	Radar vector
R	Pilot resumed own navigation
Ⓡ	Radar handoff (circle symbol when handoff completed)
E (red)	EMERGENCY
W (red)	WARNING
P	Point out initiated. Indicate the appropriate facility, sector or position. Example: PZFW.
FUEL	Minimum fuel
NOTE: The absence of an airway route number between two fixes in the route of flight indicates "direct"; no symbol or abbreviation is required.	

Section 4. Radio and Interphone Communications

2-4-1. RADIO COMMUNICATIONS

Use radio frequencies for the special purposes for which they are intended. A single frequency may be used for more than one function except as follows:

TERMINAL. When combining positions in the tower, do not use ground control frequency for airborne communications.

NOTE-

Due to the limited number of frequencies assigned to towers for the ground control function, it is very likely that airborne use of a ground control frequency could cause interference to other towers or interference to your aircraft from another tower. When combining these functions, it is recommended combining them on local control. The ATIS may be used to specify the desired frequency.

2-4-2. MONITORING

Monitor interphones and assigned radio frequencies continuously.

NOTE-

Although all FAA facilities, including RAPCONs and RATCFs, are required to monitor all assigned frequencies continuously, USAF facilities may not monitor all unpublished discrete frequencies.

2-4-3. PILOT ACKNOWLEDGMENT/READ BACK

a. When issuing clearances or instructions ensure acknowledgment by the pilot.

NOTE-

Pilots may acknowledge clearances, instructions, or other information by using "Wilco," "Roger," "Affirmative," or other words or remarks.

REFERENCE-

AIM, Contact Procedures, Para 4-2-3.

b. If altitude, heading, or other items are read back by the pilot, ensure the read back is correct. If incorrect or incomplete, make corrections as appropriate.

2-4-4. AUTHORIZED INTERRUPTIONS

As necessary, authorize a pilot to interrupt his/her communications guard.

NOTE-

Some users have adopted procedures to insure uninterrupted receiving capability with ATC when a pilot with only one operative communications radio must interrupt his/her communications guard because of a safety related problem requiring airborne communications with his/her company. In this event, pilots will request approval to abandon guard on the assigned ATC frequency for a mutually agreeable time period. Additionally, they will inform controllers of the NAVAID voice facility and the company frequency they will monitor.

2-4-5. AUTHORIZED TRANSMISSIONS

Transmit only those messages necessary for air traffic control or otherwise contributing to air safety.

REFERENCE-

FAAO 7210.3, Authorized Messages Not Directly Associated with AT Services, Para 3-2-2.

2-4-6. FALSE OR DECEPTIVE COMMUNICATIONS

Take action to detect, prevent, and report false, deceptive, or phantom controller communications to an aircraft or controller. The following shall be accomplished when false or deceptive communications occur:

a. Correct false information.

b. Broadcast an alert to aircraft operating on all frequencies within the area where deceptive or phantom transmissions have been received.

EXAMPLE-

"Attention all aircraft. False ATC instructions have been received in the area of Long Beach Airport. Exercise extreme caution on all frequencies and verify instructions."

c. Collect pertinent information regarding the incident.

d. Notify the operations supervisor of the false, deceptive, or phantom transmission and report all relevant information pertaining to the incident.

2-4-7. AUTHORIZED RELAYS

a. Relay operational information to aircraft or aircraft operators as necessary. Do not agree to handle such messages on a regular basis. Give the source of any such message you relay.

b. Relay official FAA messages as required.

NOTE-

The FAA Administrator and Deputy Administrator will sometimes use code phrases to identify themselves in air-to-ground communications as follows:

Administrator: "SAFEAIR ONE."

Deputy Administrator: "SAFEAIR TWO."

EXAMPLE-

"Miami Center, Jetstar One, this is SAFEAIR ONE, (message)."

c. Relay operational information to military aircraft operating on, or planning to operate on IRs.

2-4-8. RADIO MESSAGE FORMAT

Use the following format for radio communications with an aircraft:

a. Sector/position on initial radio contact:

1. Identification of aircraft.
2. Identification of ATC unit.
3. Message (if any).
4. The word "over" if required.

b. Subsequent radio transmissions from the same sector/position shall use the same format, except the identification of the ATC unit may be omitted.

TERMINAL. You may omit aircraft identification after initial contact when conducting the final portion of a radar approach.

REFERENCE-

FAAO 7110.65, Aircraft Identification, Para 2-4-20

2-4-9. ABBREVIATED TRANSMISSIONS

Transmissions may be abbreviated as follows:

a. Use the identification prefix and the last 3 digits or letters of the aircraft identification after communications have been established. Do not abbreviate similar sounding aircraft identifications or the identification of an air carrier or other civil aircraft having an FAA authorized call sign.

REFERENCE-

FAAO 7110.65, Aircraft Identification, Para 2-4-20

b. Omit the facility identification after communication has been established.

c. Transmit the message immediately after the callup (without waiting for the aircraft's reply) when the message is short and receipt is generally assured.

d. Omit the word "over" if the message obviously requires a reply.

2-4-10. INTERPHONE TRANSMISSION PRIORITIES

Give priority to interphone transmissions as follows:

a. First priority. Emergency messages including essential information on aircraft accidents or suspected accidents. After an actual emergency has passed, give a lower priority to messages relating to that accident.

b. Second priority. Clearances and control instructions.

c. Third priority. Movement and control messages using the following order of preference when possible:

1. Progress reports.
2. Departure or arrival reports.
3. Flight plans.

d. Fourth priority. Movement messages on VFR aircraft.

2-4-11. PRIORITY INTERRUPTION

Use the words "emergency" or "control" for interrupting lower priority messages when you have an emergency or control message to transmit.

2-4-12. INTERPHONE MESSAGE FORMAT

Use the following format for interphone intra/interfacility communications:

a. Both the caller and receiver identify their facility and/or position in a manner that insures they will not be confused with another position.

NOTE-

Other means of identifying a position, such as substituting departure or arrival gate/fix names for position identification, may be used. However, it must be operationally beneficial, and the procedure fully covered in a letter of agreement or a facility directive, as appropriate.

EXAMPLE-

Caller: "Albuquerque Center Sixty Three, Amarillo Departure."

Receiver: "Albuquerque Center."

b. Between two facilities which utilize numeric position identification, the caller must identify both facility and position.

EXAMPLE-

Caller: "Albuquerque Sixty Three, Fort Worth Eighty Two."

c. Caller states the type of coordination to be accomplished when advantageous. For example, handoff or APREQ.

d. The caller states the message.

e. The receiver states the response to the caller's message followed by the receiver's operating initials.

f. The caller states his or her operating initials.

EXAMPLE-

1.

Caller: "Denver High, R Twenty-five."

Receiver: "Denver High."

Caller: "Request direct Denver for Northwest Three Twenty-eight."

Receiver: "Northwest Three Twenty-eight direct Denver approved. H.F."

Caller: "G.M."

2.

Receiver: "Denver High, Go ahead override."

Caller: "R Twenty-five, Request direct Denver for Northwest Three Twenty-eight."

Receiver: "Northwest Three Twenty-eight direct Denver approved. H.F."

Caller: "G.M."

3.

Caller: ("Bolos" is a departure gate in Houston ARTCC's Sabine sector)– "Bolos, Houston local."

Receiver: "Bolos."

Caller: "Request Flight Level three five zero for American Twenty-five."

Receiver: "American Twenty-five Flight Level three five zero approved, A.C."

Caller: "G.M."

4.

Caller: "Sector Twelve, Ontario Approach, APREQ."

Receiver: "Sector Twelve."

Caller: "Cactus Five forty-two heading one three zero and climbing to one four thousand."

Receiver: "Cactus Five forty-two heading one three zero and climbing to one four thousand approved. B.N."

Caller: "A.M."

5.

Caller: "Zanesville, Columbus, seventy-three line, handoff."

Receiver: "Zanesville."

Caller: "Five miles east of Appleton VOR, United Three Sixty-six."

Receiver: "United Three Sixty-six, radar contact, A.Z."

Caller: "M.E."

g. Identify the interphone voice line on which the call is being made when two or more such lines are collocated at the receiving operating position.

EXAMPLE–

“Washington Center, Washington Approach on the Fifty Seven line.”

“Chicago Center, O’Hare Tower handoff on the Departure West line.”

h. TERMINAL. The provisions of subparas a, b, c, e, f, g, and para 2–4–13, Interphone Message Termination, may be omitted provided:

1. Abbreviated standard coordination procedures are contained in a facility directive describing the specific conditions and positions that may utilize an abbreviated interphone message format; and

2. There will be no possibility of misunderstanding which positions are using the abbreviated procedures.

2–4–13. INTERPHONE MESSAGE TERMINATION

Terminate interphone messages with your operating initials.

2–4–14. WORDS AND PHRASES

a. Use the words or phrases in radiotelephone and interphone communication as contained in the P/CG or, within areas where Controller Pilot Data Link Communications (CPDLC) is in use, the phraseology contained in the applicable CPDLC message set.

b. The word “heavy” shall be used as part of the identification of heavy jet aircraft as follows:

TERMINAL. In all communications with or about heavy jet aircraft.

EN ROUTE. The use of the word heavy may be omitted except as follows:

1. In communications with a terminal facility about heavy jet operations.

2. In communications with or about heavy jet aircraft with regard to an airport where the en route center is providing approach control service.

3. In communications with or about heavy jet aircraft when the separation from a following aircraft may become less than 5 miles by approved procedure.

4. When issuing traffic advisories.

EXAMPLE–

“United Fifty–Eight Heavy.”

NOTE–

Most airlines will use the word “heavy” following the company prefix and flight number when establishing communications or when changing frequencies within a terminal facility’s area.

5. When in radio communications with “Air Force One” or “Air Force Two,” do not add the heavy designator to the call sign. State only the call sign “Air Force One/Two” regardless of the type aircraft.

2–4–15. EMPHASIS FOR CLARITY

Emphasize appropriate digits, letters, or similar sounding words to aid in distinguishing between similar sounding aircraft identifications. Additionally:

a. Notify each pilot concerned when communicating with aircraft having similar sounding identifications.

EXAMPLE–

“United Thirty–one United, Miami Center, U.S. Air Thirty–oneis also on this frequency, acknowledge.”

“U.S. Air Thirty–one U.S. Air, Miami Center, United Thirty–oneis also on this frequency, acknowledge.”

REFERENCE–

FAAO 7110.65, Aircraft Identification, Para 2–4–20
FAAO 7210.3, Aircraft Identification Problems, Para 2–1–13. ■

b. Notify the operations supervisor–in–charge of any duplicate flight identification numbers or phonetically similar–sounding call signs when the aircraft are operating simultaneously within the same sector.

REFERENCE–

FAAO 7210.3, Aircraft Identification Problems, Para 2–1–13. ■

NOTE–

This is especially important when this occurs on a repetitive, rather than an isolated, basis.

2-4-16. ICAO PHONETICS

Use the ICAO pronunciation of numbers and individual letters. (See the ICAO radiotelephony alphabet and pronunciation in TBL 2-4-1.)

TBL 2-4-1
ICAO Phonetics

Character	Word	Pronunciation
0	Zero	ZE-RO
1	One	WUN
2	Two	TOO
3	Three	TREE
4	Four	FOW-ER
5	Five	FIFE
6	Six	SIX
7	Seven	SEV-EN
8	Eight	AIT
9	Nine	NIN-ER
A	Alfa	ALFAH
B	Bravo	BRAHVOH
C	Charlie	CHARLEE
D	Delta	DELLTAH
E	Echo	ECKOH
F	Foxtrot	FOKSTROT
G	Golf	GOLF
H	Hotel	HOHTELL
I	India	INDEE AH
J	Juliett	JEWLEE ETT
K	Kilo	KEYLOH
L	Lima	LEEMAH
M	Mike	MIKE
N	November	NOVEMBER
O	Oscar	OSSCAH
P	Papa	PAHPAH
Q	Quebec	KEHBECK
R	Romeo	ROWME OH
S	Sierra	SEEAIRAH
T	Tango	TANGGO
U	Uniform	YOUNEE FORM
V	Victor	VIKTAH
W	Whiskey	WISSKEY
X	X-ray	ECKSRAY
Y	Yankee	YANGKEY
Z	Zulu	ZOOLoo

NOTE-

Syllables to be emphasized in pronunciation are in bold face.

2-4-17. NUMBERS USAGE

State numbers as follows:

- a. Serial numbers. The separate digits.

EXAMPLE-

Number	Statement
11,495	"One one four niner five."
20,069	"Two zero zero six niner."

- b. Altitudes or flight levels:

1. Altitudes. Pronounce each digit in the number of hundreds or thousands followed by the word "hundred" or "thousand" as appropriate.

EXAMPLE-

Number	Statement
10,000	"One zero thousand."
11,000	"One one thousand."
17,900	"One seven thousand niner hundred."

NOTE-

Altitudes may be restated in group form for added clarity if the controller chooses.

EXAMPLE-

Number	Statement
10,000	"Ten thousand."
11,000	"Eleven thousand."
17,900	"Seventeen thousand niner hundred."

2. Flight levels. The words "flight level" followed by the separate digits of the flight level.

EXAMPLE-

Flight level	Statement
180	"Flight level one eight zero."
275	"Flight level two seven five."

3. MDA/DH Altitudes. The separate digits of the MDA/DH altitude.

EXAMPLE-

MDA/DH Altitude	Statement
1,320	“Minimum descent altitude, one three two zero.”
486	“Decision height, four eight six.”

c. Time:

1. General time information. The four separate digits of the hour and minute/s in terms of UTC.

EXAMPLE-

UTC	Time (12 hour)	Statement
0715	1:15 a.m. CST	“Zero seven one five.”
1915	1:15 p.m. CST	“One niner one five.”

2. Upon request. The four separate digits of the hours and minute/s in terms of UTC followed by the local standard time equivalent; or the local time equivalent only. Local time may be based on the 24-hour clock system, and the word “local” or the time zone equivalent shall be stated when other than UTC is referenced. The term “ZULU” may be used to denote UTC.

EXAMPLE-

UTC	Time (24 hour)	Time (12 hour)	Statement
2230	1430 PST	2:30 p.m.	“Two two three zero, one four three zero Pacific or Local.” or “Two-thirty P-M.”

3. Time check. The word “time” followed by the four separate digits of the hour and minutes, and nearest quarter minute. Fractions of a quarter minute less than eight seconds are stated as the preceding quarter minute; fractions of a quarter minute of eight seconds or more are stated as succeeding quarter minute.

EXAMPLE-

Time	Statement
1415:06	“Time, one four one five.”
1415:10	“Time, one four one five and one-quarter.”

4. Abbreviated time. The separate digits of the minutes only.

EXAMPLE-

Time	Statement
1415	“One five.”
1420	“Two zero.”

5. Field elevation. The words “field elevation” followed by the separate digits of the elevation.

EXAMPLE-

Elevation	Statement
17 feet	“Field elevation, one seven.”
817 feet	“Field elevation, eight one seven.”
2,817 feet	“Field elevation, two eight one seven.”

d. The number “0” as “zero” except where it is used in approved “group form” for authorized aircraft call signs, and in stating altitudes.

EXAMPLE-

As Zero	As Group
“Field elevation one six zero.”	“Western five thirty.”
“Heading three zero zero.”	“EMAIR One Ten.”
“One zero thousand five hundred.”	“Ten thousand five hundred.”

e. Altimeter setting. The word “altimeter” followed by the separate digits of the altimeter setting.

EXAMPLE-

Setting	Statement
30.01	“Altimeter, three zero zero one.”

f. Surface wind. The word “wind” followed by the separate digits of the indicated wind direction to the nearest 10-degree multiple, the word “at” and the separate digits of the indicated velocity in knots.

EXAMPLE-

“Wind zero three zero at two five.”

“Wind two seven zero at one five gusts three five.”

g. Heading. The word “heading” followed by the three separate digits of the number of degrees, omitting the word “degrees.” Use heading 360 degrees to indicate a north heading.

EXAMPLE-

Heading	Statement
5 degrees	“Heading zero zero five.”
30 degrees	“Heading zero three zero.”
360 degrees	“Heading three six zero.”

h. Radar beacon codes. The separate digits of the 4–digit code.

EXAMPLE-

Code	Statement
1000	“One zero zero zero.”
2100	“Two one zero zero.”

i. Runways. The word “runway,” followed by the separate digits of the runway designation. For a parallel runway, state the word “left,” “right,” or “center” if the letter “L,” “R,” or “C” is included in the designation.

EXAMPLE-

Designation	Statement
3	“Runway Three.”
8L	“Runway Eight Left.”
27R	“Runway Two Seven Right.”

j. Frequencies.

1. The separate digits of the frequency, inserting the word “point” where the decimal point occurs.

(a) Omit digits after the second digit to the right of the decimal point.

(b) When the frequency is in the L/MF band, include the word “kiloHertz.”

EXAMPLE-

Frequency	Statement
126.55 MHz	“One two six point five five.”
369.0 MHz	“Three six niner point zero.”
121.5 MHz	“One two one point five.”
135.275 MHz	“One three five point two seven.”
302 kHz	“Three zero two kiloHertz.”

2. USAF/USN. Local channelization numbers may be used in lieu of frequencies for locally based aircraft when local procedures are established to ensure that local aircraft and ATC facilities use the same channelization.

EXAMPLE-

Frequency	Statement
275.8 MHz	“Local channel one six.”

3. Issue MLS/TACAN frequencies by stating the assigned two– or three–digit channel number.

EXAMPLE-

“M–L–Schannel Five Three Zero.”
 “TACAN channel Nine Seven.”

k. Speeds.

1. The separate digits of the speed followed by “knots” except as required by para 5–7–2, Methods.

EXAMPLE-

Speed	Statement
250	“Two five zero knots.”
190	“One niner zero knots.”

2. The separate digits of the Mach number preceded by “Mach.”

EXAMPLE-

Mach Number	Statement
1.5	“Mach one point five.”
0.64	“Mach point six four.”
0.7	“Mach point seven.”

l. Miles. The separate digits of the mileage followed by the word “mile.”

EXAMPLE-

“Three zero mile arc east of Nottingham.”
 “Traffic, one o’clock, two five miles, northbound, D–C Eight, flight level two seven zero.”

2-4-18. NUMBER CLARIFICATION

a. If deemed necessary for clarity, and after stating numbers as specified in para 2-4-17, Numbers Usage, controllers may restate numbers using either group or single-digit form.

EXAMPLE-

“One Seven Thousand, Seventeen Thousand.”

“Altimeter Two Niner Niner Two, Twenty Nine Ninety Two.”

“One Two Six Point Five Five, One Twenty Six Point Fifty Five.”

2-4-19. FACILITY IDENTIFICATION

Identify facilities as follows:

a. Airport traffic control towers. State the name of the facility followed by the word “tower.” Where military and civil airports are located in the same general area and have similar names, state the name of the military service followed by the name of the military facility and the word “tower.”

EXAMPLE-

“Columbus Tower.”

“Barksdale Tower.”

“Navy Jacksonville Tower.”

b. Air route traffic control centers. State the name of the facility followed by the word “center.”

c. Approach control facilities, including RAP-CONS, RATCFs, and ARACs. State the name of the facility followed by the word “approach.” Where military and civil facilities are located in the same general area and have similar names, state the name of the military service followed by the name of the military facility and the word “approach.”

EXAMPLE-

“Denver Approach.”

“Griffiss Approach.”

“Navy Jacksonville Approach.”

d. Functions within a terminal facility. State the name of the facility followed by the name of the function.

EXAMPLE-

“Boston Departure.”

“LaGuardia Clearance Delivery.”

“O’Hare Ground.”

e. When calling or replying on an interphone line which connects only two non-VSCS equipped facilities, you may omit the facility name.

EXAMPLE-

“Bradford High, Handoff.”

f. FAA flight service stations. State the name of the station followed by the word “radio.”

EXAMPLE-

“Altoona Radio.”

g. Radar facilities having ASR or PAR but not providing approach control service. State the name of the facility, followed by the letters “G-C-A.”

EXAMPLE-

“Corpus Christi G-C-A.”

“Davison G-C-A.”

2-4-20. AIRCRAFT IDENTIFICATION

Use the full identification in reply to aircraft with similar sounding identifications. For other aircraft, the same identification may be used in reply that the pilot used in his/her initial callup except use the correct identification after communications have been established. Identify aircraft as follows:

a. U.S. registry aircraft. State one of the following:

REFERENCE-

FAAO 7110.65, Radio Message Format, Para 2-4-8

FAAO 7110.65, Abbreviated Transmissions, Para 2-4-9

FAAO 7110.65, Emphasis for Clarity, Para 2-4-15

FAAO 7110.65, Numbers Usage, Para 2-4-17

1. Civil. State the prefix “November” when establishing initial communications with U.S. registered aircraft followed by the ICAO phonetic pronunciation of the numbers/letters of the aircraft registration. The controller may state the aircraft type, the model, the manufacturer’s name, followed by the ICAO phonetic pronunciation of the numbers/letters of the aircraft registration if used by the pilot on the initial or subsequent call.

EXAMPLE-

Air traffic controller’s initiated call:

“November One Two Three Four Golf.”

“November One Two Three Four.”

Responding to pilot’s initial or subsequent call:

“Jet Commander One Two Three Four Papa.”

“Bonanza One Two Three Four Tango.”

“Sikorsky Six Three Eight Mike Foxtrot.”

NOTE-

If aircraft identification becomes a problem when the procedures specified above are used, the call sign shall be restated after the flight number of the aircraft involved.

EXAMPLE-

*“American Five Twenty–One American.”
 “Commuter Six Eleven Commuter.”
 “General Motors Thirty–Seven General Motors.”*

REFERENCE-

FAAO 7210.3, *Aircraft Identification Problems, Para 2–1–13.*

2. Air carrier and other civil aircraft having FAA authorized call signs. State the call sign followed by the flight number in group form.

NOTE-

“Group form” is the pronunciation of a series of numbers as the whole number, or pairs of numbers they represent rather than pronouncing each separate digit. The use of group form may, however, be negated by four-digit identifiers or the placement of zeros in the identifier.

EXAMPLE-

*“American Fifty–Two.”
 “Delta One Hundred.”
 “Eastern Metro One Ten.”
 “General Motors Thirty Fifteen.”
 “United One Zero One.”
 “Delta Zero One Zero.”
 “TWA Ten Zero Four.”*

NOTE-

Air carrier and other civil aircraft having FAA authorized call signs may be pronounced using single digits if necessary for clarity.

EXAMPLE-

*“United Five One Seven.”
 “United Five Seven Zero.”*

3. Air taxi and commercial operators not having FAA authorized call signs. State the prefix “TANGO” on initial contact, if used by the pilot, followed by the registration number. The prefix may be dropped in subsequent communications.

EXAMPLE-

*“Tango Mooney Five Five Five Two Quebec.”
 “Tango November One Two Three Four.”*

4. Air carrier/taxi ambulance. State the prefix, “Lifeguard,” if used by the pilot, followed by the call sign and flight number in group form.

EXAMPLE-

“Lifeguard Delta Fifty–One.”

5. Civilian air ambulance. State the word “LIFEGUARD” followed by the numbers/letters of the registration number.

EXAMPLE-

“Lifeguard Two Six Four Six.”

6. U.S. military. State one of the following:

(a) The service name, followed by the word “copter,” when appropriate, and the last 5 digits of the serial number.

EXAMPLE-

*“Navy Five Six Seven One Three.”
 “Coast Guard Six One Three Two Seven.”
 “Air Guard One Three Five Eight Six.”
 “Army Copter Three Two One Seven Six.”*

NOTE-

If aircraft identification becomes a problem, the procedures reflected in FAAO 7210.3, Facility Operation and Administration, Aircraft Identification Problems, para 2–1–13, will apply.

(b) Special military operations. State one of the following followed by the last 5 digits of the serial number:

(c) Air evacuation flights. “AIR EVAC,” “MARINE AIR EVAC,” or “NAVY AIR EVAC.”

EXAMPLE-

“Air Evac One Seven Six Five Two.”

(d) Rescue flights. (Service name) “RESCUE.”

EXAMPLE-

“Air Force Rescue Six One Five Seven Niner.”

(e) Air Mobility Command. “REACH.”

EXAMPLE-

“Reach Seven Eight Five Six Two.”

(f) Special Air Mission. “SAM.”

EXAMPLE-

“Sam Niner One Five Six Two.”

(g) USAF Contract Aircraft “LOGAIR.”

EXAMPLE-

“Logair Seven Five Eight Two Six.”

(h) Military tactical and training:

(1) U.S. Air Force, Air National Guard, Military District of Washington priority aircraft, and USAF civil disturbance aircraft. Pronounceable words of 3 to 6 letters followed by a 1 to 5 digit number.

EXAMPLE-

*“Paul Two Zero.”
 “Pat One Five Seven.”
 “Gaydog Four.”*

NOTE-

When the “Z” suffix described in para 2–3–6 USAF/USN Undergraduate Pilots, is added to identify aircraft piloted by USAF undergraduate pilots, the call sign will be limited to a combination of six characters.

(2) Navy or Marine fleet and training command aircraft. The service name and 2 letters, or a digit and a letter (use letter phonetic equivalents), followed by 2 or 3 digits.

EXAMPLE-

“Navy Golf Alfa Two One.”
 “Marine Four Charlie Two Three Six.”

(i) NORAD interceptors. An assigned double letter 2-digit flight number.

EXAMPLE-

“Alfa Kilo One Five.”

7. Presidential aircraft and Presidential family aircraft:

(a) When the President is aboard a military aircraft, state the name of the military service, followed by the word “One.”

EXAMPLE-

“Air Force One.”
 “Army One.”
 “Marine One.”

(b) When the President is aboard a civil aircraft, state the words “Executive One.”

(c) When a member of the President’s family is aboard any aircraft, if the U.S. Secret Service or the White House Staff determines it is necessary, state the words “Executive One Foxtrot.”

REFERENCE-

FAAO 7110.65, Operational Priority, Para 2-1-4

8. Vice Presidential aircraft:

(a) When the Vice President is aboard a military aircraft, state the name of the military service, followed by the word “Two.”

EXAMPLE-

“Air Force Two.”
 “Army Two.”
 “Marine Two.”

(b) When the Vice President is aboard a civil aircraft, state the words “Executive Two.”

(c) When a member of the Vice President’s family is aboard any aircraft, if the U.S. Secret Service or the White House Staff determines it is necessary, state the words “Executive Two Foxtrot.”

REFERENCE-

FAAO 7110.65, Operational Priority, Para 2-1-4

9. DOT and FAA flights. The following alphanumeric identifiers and radio/interphone call signs are established for use in air/ground commu-

nications when the Secretary of Transportation, Deputy Secretary of Transportation, FAA Administrator or FAA Deputy Administrator have a requirement to identify themselves.

(See TBL 2-4-2.)

TBL 2-4-2

DOT and FAA Alphanumeric Identifiers and Call Signs

Official	Identifier	Call Sign
Secretary of Transportation	DOT-1	Transport-1
Deputy Secretary of Transportation	DOT-2	Transport-2
Administrator, Federal Aviation Administration	FAA-1	Safeair-1
Deputy Administrator, Federal Aviation Administration	FAA-2	Safeair-2

10. Other Special Flights.

(a) Department of Energy flights. State the letters “R-A-C” (use phonetic alphabet equivalents) followed by the last 4 separate digits of the aircraft registration number.

EXAMPLE-

“Romeo Alfa Charlie One Six Five Three.”

(b) Flight Inspection of navigational aids. State the call sign “FLIGHT CHECK” followed by the digits of the registration number.

EXAMPLE-

“Flight Check Three Niner Six Five Four.”

(c) USAF aircraft engaged in aerial sampling missions. State the call sign “SAMP” followed by the last three digits of the serial number.

EXAMPLE-

“SAMP Three One Six.”

REFERENCE-

FAAO 7110.65, SAMP, Para 9-3-16

11. Use a pilot’s name in identification of an aircraft only in special or emergency situations.

b. Foreign registry. State one of the following:

1. Civil. State the aircraft type or the manufacturer’s name followed by the letters/numbers of the aircraft registration, or state the letters or digits of the aircraft registration or call sign.

EXAMPLE-

“Stationair F-L-R-B.”
 “C-F-L-R-B.”

NOTE-

Letters may be spoken individually or phonetically.

2. Air carrier. The abbreviated name of the operating company followed by the letters or digits of the registration or call sign.

EXAMPLE-

“Air France F-L-R-L-G.”

3. The flight number in group form, or you may use separate digits if that is the format used by the pilot.

EXAMPLE-

“Scandinavian Sixty-eight.”

“Scandinavian Six Eight.”

4. Foreign Military. Except Canada, the name of the country and the military service followed by the separate digits or letters of the registration or call sign. Canadian Armed Force aircraft shall be identified by the word “Canforce” followed by the separate digits of the serial number, except that the Transport Command of the Canadian Armed Force shall be identified by the words “Canadian Military” and the Canadian Coast Guard shall be identified as “Canadian Coast Guard” followed by the separate digits of the serial number.

EXAMPLE-

“Canforce Five Six Two Seven.”

“Brazilian Air Force Five Three Two Seven Six.”

2-4-21. DESCRIPTION OF AIRCRAFT TYPES

Except for heavy aircraft, describe aircraft as follows when issuing traffic information.

a. Military:

1. Military designator, with numbers spoken in group form, or

2. Service and type, or

3. Type only if no confusion or misidentification is likely.

b. Air Carrier:

1. Manufacturer’s model or designator.

2. Add the manufacturer’s name, company name or other identifying features when confusion or misidentification is likely.

EXAMPLE-

“L-Ten-Eleven.”

“American MD-Eighty. Seven Thirty-Seven.”

“Boeing Seven Fifty-Seven.”

NOTE-

Pilots of “interchange” aircraft are expected to inform the tower on the first radio contact the name of the operating company and trip number followed by the company name, as displayed on the aircraft, and the aircraft type.

c. General Aviation and Air Taxi:

1. Manufacturer’s model, or designator.

2. Manufacturer’s name, or add color when considered advantageous.

EXAMPLE-

“Tri-Pacer”

“P A Twenty-Two.”

“Cessna Four-Oh-One.”

“Blue and white King Air.”

“Airliner.”

“Sikorsky S-Seventy-Six.”

d. When issuing traffic information to aircraft following a heavy jet, specify the word “heavy” before the manufacturer’s name and model.

EXAMPLE-

“Heavy L-Ten-Eleven.”

“Heavy C-Five.”

“Heavy Boeing Seven Forty-Seven.”

REFERENCE-

FAAO 7110.65, Traffic Advisories, Para 2-1-21

2-4-22. AIRSPACE CLASSES

A, B, C, D, E, and G airspace are pronounced in the ICAO phonetics for clarification. The term “Class” may be dropped when referring to airspace in pilot/controller communications.

EXAMPLE-

“Cessna 123 Mike Romeo cleared to enter Bravo airspace.”

“Sikorsky 123 Tango Sierra cleared to enter New York Bravo airspace.”

Section 5. Route and NAVAID Description

2-5-1. AIR TRAFFIC SERVICE (ATS) ROUTES

Describe ATS routes as follows:

a. VOR/VORTAC/TACAN airways or jet routes. State the word “Victor” or the letter “J” followed by the number of the airway or route in group form.

EXAMPLE-

“Victor Twelve.”

“J Five Thirty-Three.”

b. VOR/VORTAC/TACAN alternate airways. State the word “Victor” followed by the number of the airway in group form and the alternate direction.

EXAMPLE-

“Victor Twelve South.”

c. Colored/L/MF airways. State the color of the airway followed by the number in group form.

EXAMPLE-

“Blue Eighty-One.”

d. Named Routes. State the words “North American Route” or “Bahama Route” followed by the number of the route in group form.

EXAMPLE-

“North American Route Sixty-Seven Bravo.”

“Bahama Route Fifty-Five Victor.”

e. Air Traffic Service (ATS) routes. State the letter(s) of the route phonetically, followed by the number of the route in group form.

EXAMPLE-

“Romeo Twenty.”

“Alfa Fifty.”

“Golf Sixty-one.”

“Alfa Seven Hundred.”

f. Military Training Routes (MTRs). State the letters “I-R” or “V-R” followed by the number of the route in group form.

EXAMPLE-

“I-R Five Thirty-one.”

“V-R Fifty-two.”

g. Published RNAV routes. State the letter “Q” followed by the route number in group form except in Alaska where RNAV routes are followed with the letter “R.”

EXAMPLE-

“Q One Forty-five.”

2-5-2. NAVAID TERMS

Describe radials, arcs, courses, bearings, and quadrants of NAVAIDs as follows:

a. VOR/VORTAC/TACAN/MLS/GPS Waypoint. State the name of the NAVAID or GPS Waypoint followed by the separate digits of the radial/azimuth/bearing (omitting the word “degrees”) and the word “radial/azimuth/bearing.”

EXAMPLE-

“Appleton Zero Five Zero Radial.”

“Lindburg Runway Two Seven M-L-S, Two Six Zero Azimuth.”

b. Arcs about VOR-DME/VORTAC/TACAN/MLS NAVAIDs. State the distance in miles from the NAVAID followed by the words “mile arc,” the direction from the NAVAID in terms of the eight principal points of the compass, the word “of,” and the name of the NAVAID.

EXAMPLE-

“Two Zero mile arc southwest of O’Hare Runway Two Seven Left M-L-S.”

c. Quadrant within a radius of NAVAID. State direction from NAVAID in terms of the quadrant; e.g., NE, SE, SW, NW, followed by the distance in miles from the NAVAID.

EXAMPLE-

“Cleared to fly northeast quadrant of Phillipsburg VORTAC within Four Zero mile radius.”

REFERENCE-

FAAO 7110.65, Route Use, Para 4-4-1

P/CG Term- Quadrant.

d. Nondirectional beacons. State the course to or the bearing from the radio beacon, omitting the word “degree,” followed by the words “course to” or “bearing from,” the name of the radio beacon, and the words “radio beacon.”

EXAMPLE-

“Three Four Zero bearing from Randolph Radio Beacon.”

e. MLS. State the azimuth to or azimuth from the MLS, omitting the word “degree” followed by the words “azimuth to” or “azimuth from,” the name of the MLS, and the term MLS.

EXAMPLE-

“Two Six Zero azimuth to Linburgh Runway Two Seven MLS.”

f. Navigation Reference System (NRS) Waypoint. State the single letter corresponding to the ICAO Flight Information Region (FIR) identifier, followed by the letter corresponding to the FIR subset (ARTCC area for the conterminous U.S.), the latitude increment in single digit or group form, and the longitude increment.

EXAMPLE-

“Kilo Delta Three Four Uniform.”

“Kilo Delta Thirty Four Uniform.”

2-5-3. NAVAID FIXES

Describe fixes determined by reference to a radial/localizer/azimuth and distance from a VOR-DME/VORTAC/TACAN/ILS-DME or MLS as follows:

a. When a fix is not named, state the name of the NAVAID followed by a specified radial/localizer/azimuth, and state the distance in miles followed by the phrase “mile fix.”

EXAMPLE-

“Appleton Zero Five Zero radial Three Seven mile fix.”

“Reno localizer back course Four mile fix.”

“Hobby Runway One Two M-L-S Zero Niner Zero azimuth One Two mile fix.”

b. When a fix is charted on a DP, STAR, en route chart, or approach plate, state the name of the fix.

c. Use specific terms to describe a fix. Do not use expressions such as “passing Victor Twelve” or “passing J Eleven.”

Section 6. Weather Information

2-6-1. FAMILIARIZATION

Become familiar with pertinent weather information when coming on duty, and stay aware of current weather information needed to perform ATC duties.

2-6-2. HAZARDOUS INFLIGHT WEATHER ADVISORY SERVICE (HIWAS)

Controllers shall advise pilots of hazardous weather that may impact operations within 150 NM of their sector or area of jurisdiction. Hazardous weather information contained in HIWAS broadcasts includes Airmen's Meteorological Information (AIRMET), Significant Meteorological Information (SIGMET), Convective SIGMET (WST), Urgent Pilot Weather Reports (UUA), and Center Weather Advisories (CWA). Facilities shall review alert messages to determine the geographical area and operational impact for hazardous weather information broadcasts. The broadcast is not required if aircraft on your frequency(s) will not be affected.

a. Controllers within commissioned HIWAS areas shall broadcast a HIWAS alert on all frequencies, except emergency frequency, upon receipt of hazardous weather information. Controllers are required to disseminate data based on the operational impact on the sector or area of control jurisdiction.

NOTE-

The inclusion of the type and number of weather advisory responsible for the HIWAS advisory is optional.

PHRASEOLOGY-

ATTENTION ALL AIRCRAFT. HAZARDOUS WEATHER INFORMATION (SIGMET, Convective SIGMET, AIRMET, Urgent Pilot Weather Report (UUA), or Center Weather Advisory (CWA), Number or Numbers) FOR (geographical area) AVAILABLE ON HIWAS, FLIGHT WATCH, OR FLIGHT SERVICE FREQUENCIES.

b. Controllers outside of commissioned HIWAS areas shall:

1. Advise pilots of the availability of hazardous weather advisories. Pilots requesting additional information should be directed to contact the nearest Flight Watch or Flight Service.

2. Apply the same procedure when HIWAS outlets, or outlets with radio coverage extending into

your sector or airspace under your jurisdiction, are out of service.

PHRASEOLOGY-

ATTENTION ALL AIRCRAFT. HAZARDOUS WEATHER INFORMATION FOR (geographical area) AVAILABLE FROM FLIGHT WATCH OR FLIGHT SERVICE.

c. Terminal facilities have the option to limit hazardous weather information broadcasts as follows: Tower cab and approach control facilities may opt to broadcast hazardous weather information alerts only when any part of the area described is within 50 NM of the airspace under their jurisdiction.

REFERENCE-

AIM, Chapter 7, Section 1, Meteorology, Para 7-1-5 through Para 7-1-9.

2-6-3. PIREP INFORMATION

Significant PIREP information includes reports of strong frontal activity, squall lines, thunderstorms, light to severe icing, wind shear and turbulence (including clear air turbulence) of moderate or greater intensity, volcanic eruptions and volcanic ash clouds, and other conditions pertinent to flight safety.

REFERENCE-

FAAO 7110.65, Low Level Wind Shear/Microburst Advisories, Para 3-1-8

FAAO 7210.3, Handling of SIGMETs, CWAs, and PIREPs, Para 6-3-1. AIM, Flight Operations in Volcanic Ash, Para 7-5-8.

FAAO 7210.3, SIGMET and PIREP Handling, Para 10-3-1.

a. Solicit PIREPs when requested or when one of the following conditions exists or is forecast for your area of jurisdiction:

1. Ceilings at or below 5,000 feet. These PIREPs shall include cloud base/top reports when feasible.

TERMINAL. Ensure that at least one descent/climb-out PIREP, including cloud base/s, top/s, and other related phenomena, is obtained each hour.

EN ROUTE. When providing approach control services, the requirements stated in TERMINAL above apply.

2. Visibility (surface or aloft) at or less than 5 miles.

3. Thunderstorms and related phenomena.

4. Turbulence of moderate degree or greater.

5. Icing of light degree or greater.

6. Wind shear.
7. Volcanic ash clouds.

NOTE—

Pilots may forward PIREPs regarding volcanic activity using the format described in the Volcanic Activity Reporting Form (VAR) as depicted in the AIM, Appendix 2.

8. **TERMINAL.** Braking Action Advisories are in effect.

REFERENCE—

FAAO 7110.65, *Braking Action Advisories, Para 3-3-5 P/CG Term— Braking Action Advisories.*

b. Record with the PIREPs:

1. Time.
2. Aircraft position.
3. Type aircraft.
4. Altitude.
5. When the PIREP involves icing include:

(a) Icing type and intensity.

(b) Air temperature in which icing is occurring.

c. Obtain PIREPs directly from the pilot, or if the PIREP has been requested by another facility, you may instruct the pilot to deliver it directly to that facility.

PHRASEOLOGY—**REQUEST/SAY FLIGHT CONDITIONS.**

Or if appropriate,

REQUEST/SAY (specific conditions; i.e., ride, cloud, visibility, etc.) CONDITIONS.

If necessary,

OVER (fix),

or

ALONG PRESENT ROUTE,

or

BETWEEN (fix) AND (fix).

d. Handle PIREPs as follows:

1. Relay pertinent PIREP information to concerned aircraft in a timely manner.

2. **EN ROUTE.** Relay all operationally significant PIREPs to the facility weather coordinator.

3. **TERMINAL.** Relay all operationally significant PIREPs to:

(a) The appropriate intrafacility positions.

(b) The FSS serving the area in which the report was obtained.

NOTE—

The FSS is responsible for long line dissemination.

(c) Other concerned terminal or en route ATC facilities, including non-FAA facilities.

(d) Use the word *gain* and/or *loss* when describing to pilots the effects of wind shear on airspeed.

EXAMPLE—

“Delta Seven Twenty-one, a Boeing Seven Twenty-seven, previously reported wind shear, loss of Two Five knots at Four Hundred feet.”

“U.S. Air Seventy-six, a D-C Niner, previously reported wind shear, gain of Twenty-Five knots between Niner Hundred and Six Hundred feet, followed by a loss of Five Zero knots between Five Hundred feet and the surface.”

REFERENCE—

AIM, Wind Shear PIREPs, Para 7-1-25.

2-6-4. WEATHER AND CHAFF SERVICES

a. Issue pertinent information on observed/reported weather or chaff areas. Provide radar navigational guidance and/or approve deviations around weather or chaff areas when requested by the pilot. Do not use the word “turbulence” in describing radar-derived weather.

1. Issue weather and chaff information by defining the area of coverage in terms of azimuth (by referring to the 12-hour clock) and distance from the aircraft or by indicating the general width of the area and the area of coverage in terms of fixes or distance and direction from fixes.

2. Issue the level of echo intensity when that information is available.

3. When equipment limitations exist, controllers shall, at a minimum, ensure that the highest available level of echo intensity within their area of jurisdiction is displayed.

4. When a deviation cannot be approved as requested and the situation permits, suggest an alternative course of action.

b. In areas of significant weather, plan ahead and be prepared to suggest, upon pilot request, the use of alternative routes/altitudes.

NOTE—

Weather significant to the safety of aircraft includes such conditions as tornadoes, lines of thunderstorms, embedded thunderstorms, large hail, wind shear, microbursts, moderate to extreme turbulence (including CAT), and light to severe icing.

c. Inform any tower for which you provide approach control services if you observe any weather echoes on radar which might affect their operations.

PHRASEOLOGY—

WEATHER/CHAFF AREA BETWEEN (number) O’CLOCK AND (number) O’CLOCK (number) MILES,

or

(number) MILE BAND OF WEATHER/CHAFF FROM (fix or number of miles and direction from fix) TO (fix or number of miles and direction from fix),

or

LEVEL (number(s)) WEATHER ECHO BETWEEN (number) O’CLOCK AND (number) O’CLOCK, (number) MILES. MOVING (direction) AT (number) KNOTS, TOPS (altitude),

or

DEVIATION APPROVED, (restrictions if necessary), ADVISE WHEN ABLE TO:

RETURN TO COURSE,

or

RESUME OWN NAVIGATION

or

FLY HEADING (heading)

or

PROCEED DIRECT TO (name of NAVAID). UNABLE DEVIATION (state possible alternate course of action).

EXAMPLE—

1. “Level five weather echo between eleven o’clock and one o’clock, one zero miles. Moving east at two zero knots, tops flight level three niner zero.”

2. “Level four weather echo between ten o’clock and two

o’clock, one five miles. Weather area is two five miles in diameter.”

3. “Level four and five weather echoes between ten o’clock and two o’clock, one five miles. Weather area is two five miles in diameter.”

4. “Level two through four weather echoes between ten o’clock and two o’clock, one five miles. Weather area is two five miles in diameter.”

NOTE—

Phraseology using level number(s) is only applicable when the radar weather echo intensity information is determined by NWS radar equipment or digitized radar equipment.

REFERENCE—

P/CG Term— Radar Weather Echo Intensity Levels.

d. The supervisory traffic management coordinator-in-charge/operations supervisor/controller-in-charge shall verify the digitized radar weather information by the best means available (e.g., pilot reports, local tower personnel, etc.) if the weather data displayed by digitized radar is reported as questionable or erroneous. Errors in weather radar presentation shall be reported to the AF technician and the AT supervisor shall determine if the digitized radar derived weather data is to be displayed and a NOTAM distributed.

NOTE—

Anomalous propagation (AP) is a natural occurrence affecting radar and does not in itself constitute a weather circuit failure.

2-6-5. CALM WIND CONDITIONS

TERMINAL. Describe the wind as calm when the wind velocity is less than three knots.

REFERENCE—

FAAO 7110.65, Tailwind Components, Para 3-5-3

FAAO 7110.65, Intersecting Runway Separation, Para 3-10-4

2-6-6. REPORTING WEATHER CONDITIONS

a. When the prevailing visibility at the usual point of observation, or at the tower level, is less than 4 miles, tower personnel shall take prevailing visibility observations and apply the observations as follows:

1. Use the lower of the two observations (tower or surface) for aircraft operations.

2. Forward tower visibility observations to the weather observer.

3. Notify the weather observer when the tower observes the prevailing visibility decrease to less than 4 miles or increase to 4 miles or more.

b. Forward current weather changes to the appropriate control facility as follows:

1. When the official weather changes to a condition which is below 1,000-foot ceiling or below the highest circling minimum, whichever is greater, or less than 3 miles visibility, and when it improves to a condition which is better than those above.

2. Changes which are classified as special weather observations during the time that weather conditions are below 1,000-foot ceiling or the highest circling minimum, whichever is greater, or less than 3 miles visibility.

c. Towers at airports where military turbo-jet en route descents are routinely conducted shall also report the conditions to the ARTCC even if it is not the controlling facility.

d. If the receiving facility informs you that weather reports are not required for a specific time period, discontinue the reports. The time period specified should not exceed the duration of the receiving controller's tour of duty.

e. *EN ROUTE*. When you determine that weather reports for an airport will not be required for a specific time period, inform the FSS or tower of this determination. The time period specified should not exceed the duration of receiving controller's tour of duty.

REFERENCE-

FAAO 7110.65, *Forwarding Approach Information by Nonapproach Control Facilities, Para 3-10-2*

2-6-7. DISSEMINATING WEATHER INFORMATION

TERMINAL. Observed elements of weather information shall be disseminated as follows:

a. General weather information, such as "large breaks in the overcast," "visibility lowering to the south," or similar statements which do not include specific values, and any elements derived directly from instruments, pilots, or radar may be transmitted to pilots or other ATC facilities without consulting the weather reporting station.

b. Specific values, such as ceiling and visibility, may be transmitted if obtained by one of the following means:

1. You are properly certificated and acting as official weather observer for the elements being reported.

NOTE-

USAF controllers do not serve as official weather observers.

2. You have obtained the information from the official observer for the elements being reported.

3. The weather report was composed or verified by the weather station.

4. The information is obtained from an official Automated Weather Observation System (AWOS) or an Automated Surface Observation System (ASOS).

c. Differences between weather elements observed from the tower and those reported by the weather station shall be reported to the official observer for the element concerned.

Section 7. Altimeter Settings

2-7-1. CURRENT SETTINGS

a. Current altimeter settings shall be obtained from direct-reading instruments or directly from weather reporting stations.

REFERENCE-

FAAO 7210.3, Chapter 2, Section 10, Wind/Altimeter Information.

b. If a pilot requests the altimeter setting in millibars, ask the nearest weather reporting station for the equivalent millibar setting.

c. USAF/USA. Use the term “Estimated Altimeter” for altimeter settings reported or received as estimated.

REFERENCE-

FAAO 7110.65, Departure Information, Para 3-9-1

FAAO 7110.65, Landing Information, Para 3-10-1

FAAO 7110.65, Approach Information, Para 4-7-10

2-7-2. ALTIMETER SETTING ISSUANCE BELOW LOWEST USABLE FL

a. **TERMINAL.** Identify the source of an altimeter setting when issued for a location other than the aircraft’s departure or destination airport.

b. **EN ROUTE.** Identify the source of all altimeter settings when issued.

PHRASEOLOGY-

THE (facility name) (time of report if more than one hour old) ALTIMETER (setting).

c. Issue the altimeter setting:

1. To en route aircraft at least one time while operating in your area of jurisdiction. Issue the setting for the nearest reporting station along the aircraft’s route of flight:

NOTE-

14 CFR Section 91.121(1) requires that the pilot set his/her altimeter to the setting of a station along his/her route of flight within 100 miles of the aircraft if one is available. However, issuance of the setting of an adjacent station during periods that a steep gradient exists will serve to inform the pilot of the difference between the setting he/she is using and the pressure in the local area and better enable him/her to choose a more advantageous setting within the limitations of 14 CFR Section 91.121.

2. **TERMINAL.** To all departures. Unless specifically requested by the pilot, the altimeter setting need not be issued to local aircraft operators who have requested this omission in writing or to scheduled air carriers.

REFERENCE-

FAAO 7110.65, Departure Information, Para 3-9-1

3. **TERMINAL.** To arriving aircraft on initial contact or as soon as possible thereafter. The tower may omit the altimeter if the aircraft is sequenced or vectored to the airport by the approach control having jurisdiction at that facility.

REFERENCE-

FAAO 7110.65, Approach Information, Para 4-7-10

FAAO 7110.65, Approach Information, Para 5-10-2

4. **EN ROUTE.** For the destination airport to arriving aircraft, approximately 50 miles from the destination, if an approach control facility does not serve the airport.

5. In addition to the altimeter setting provided on initial contact, issue changes in altimeter setting to aircraft executing a nonprecision instrument approach as frequently as practical when the official weather report includes the remarks “pressure falling rapidly.”

d. If the altimeter setting must be obtained by the pilot of an arriving aircraft from another source, instruct the pilot to obtain the altimeter setting from that source.

NOTE-

1. *The destination altimeter setting, whether from a local or remote source, is the setting upon which the instrument approach is predicated.*

2. *Approach charts for many locations specify the source of altimeter settings as non-FAA facilities, such as UNICOMs.*

e. When issuing clearance to descend below the lowest usable flight level, advise the pilot of the altimeter setting of the weather reporting station nearest the point the aircraft will descend below that flight level.

f. Department of Defense (DOD) aircraft which operate on “single altimeter settings” (CFR Exemption 2861A) shall be issued altimeter settings in accordance with standard procedures while the aircraft are en route to and from their restricted areas, MOAs, and ATC assigned airspace areas.

g. When the barometric pressure is greater than 31.00 inches Hg., issue the altimeter setting and:

1. En Route/Arrivals. Advise pilots to remain set on altimeter 31.00 until reaching final approach segment.

2. Departures. Advise pilots to set altimeter 31.00 prior to reaching any mandatory/crossing altitude or 1,500 feet AGL, whichever is lower.

PHRASEOLOGY-

ALTIMETER, THREE ONE TWO FIVE, SET THREE ONE ZERO ZERO UNTIL REACHING THE FINAL APPROACH FIX.

or

ALTIMETER, THREE ONE ONE ZERO, SET THREE ONE ZERO ZERO PRIOR TO REACHING ONE THOUSAND THREE HUNDRED.

NOTE-

1. Aircraft with Mode C altitude reporting will be displayed on the controller's radar scope with a uniform altitude offset above the assigned altitude. With an actual altimeter of 31.28 inches Hg, the Mode C equipped aircraft will show 3,300 feet when assigned 3,000 feet. This will occur unless local directives authorize entering the altimeter setting 31.00 into the computer system regardless of the actual barometric pressure.

2. Flight Standards will implement high barometric pressure procedures by NOTAM defining the geographic area affected.

3. Airports unable to accurately measure barometric pressures above 31.00 inches Hg. will report the barometric pressure as "missing" or "in excess of 31.00 inches of Hg." Flight operations to or from those airports are restricted to VFR weather conditions.

REFERENCE-

AIM, Procedures, Para 7-2-2.

FAAO 7110.65, Landing Information, Para 3-10-1

Section 8. Runway Visibility Reporting– Terminal

2–8–1. FURNISH RVR/RVV VALUES

Where RVR or RVV equipment is operational, irrespective of subsequent operation or nonoperation of navigational or visual aids for the application of RVR/RVV as a takeoff or landing minima, furnish the values for the runway in use in accordance with para 2–8–3, Terminology.

NOTE–

Readout capability of different type/model RVR equipment varies. For example, older equipment minimum readout value is 600 feet. Newer equipment may have minimum readout capability as low as 100 feet. Readout value increments also may differ. Older equipment have minimum readout increments of 200 feet. New equipment increments below 800 feet are 100 feet.

REFERENCE–

*FAAO 6560.10, Runway Visual Range (RVR).
FAAO 6750.24, Instrument Landing System (ILS) and Ancillary Electronic Component Configuration & Perf. Req.*

2–8–2. ARRIVAL/DEPARTURE RUNWAY VISIBILITY

a. Issue current touchdown RVR/RVV for the runway(s) in use:

1. When prevailing visibility is 1 mile or less regardless of the value indicated.
2. When RVR/RVV indicates a reportable value regardless of the prevailing visibility.

NOTE–

Reportable values are: RVR 6,000 feet or less; RVV 1½ miles or less.

3. When it is determined from a reliable source that the indicated RVR value differs by more than 400 feet from the actual conditions within the area of the transmissometer, the RVR data is not acceptable and shall not be reported.

NOTE–

A reliable source is considered to be a certified weather observer, automated weather observing system, air traffic controller, flight service specialist, or pilot.

4. When the observer has reliable reports, or has otherwise determined that the instrument values are

not representative of the associated runway, the data shall not be used.

b. Issue both mid-point and roll-out RVR when the value of either is less than 2,000 feet and the touchdown RVR is greater than the mid-point or roll-out RVR.

c. Local control shall issue the current RVR/RVV to each aircraft prior to landing or departure in accordance with subparas a and b.

2–8–3. TERMINOLOGY

a. Provide RVR/RVV information by stating the runway, the abbreviation RVR/RVV, and the indicated value. When issued along with other weather elements, transmit these values in the normal sequence used for weather reporting.

EXAMPLE–

“Runway One Four RVR Two Thousand Four Hundred.”

“Runway Three Two RVV Three Quarters.”

b. When two or more RVR systems serve the runway in use, report the indicated values for the different systems in terms of touchdown, mid, and rollout as appropriate.

EXAMPLE–

“Runway Two Two Left RVR Two Thousand, rollout One Thousand Eight Hundred.”

“Runway Two Seven Right RVR One Thousand, mid Eight Hundred, rollout Six Hundred.”

c. When there is a requirement to issue an RVR or RVV value and a visibility condition greater or less than the reportable values of the equipment is indicated, state the condition as “MORE THAN” or “LESS THAN” the appropriate minimum or maximum readable value.

EXAMPLE–

“Runway Three Six RVR more than Six Thousand.”

“Runway Niner RVR One Thousand, rollout less than Six Hundred.”

d. When a readout indicates a rapidly varying visibility condition (1,000 feet or more for RVR; one or more reportable values for RVV), report the current value followed by the range of visibility variance.

EXAMPLE-

“Runway Two Four RVR Two Thousand, variable One Thousand Six Hundred to Three Thousand.”

“Runway Three One RVV Three-quarters, variable One-quarter to One.”

REFERENCE-

FAAO 7110.65, Furnish RVR/RVV Values, Para 2-8-1

Section 9. Automatic Terminal Information Service Procedures

2-9-1. APPLICATION

Use the ATIS, where available, to provide advance noncontrol airport/terminal area and meteorological information to aircraft.

a. Identify each ATIS message by a phonetic letter code word at both the beginning and the end of the message. Automated systems will have the phonetic letter code automatically appended. Exceptions may be made where omissions are required because of special programs or equipment.

1. Each alphabet letter phonetic word shall be used sequentially, except as authorized in subpara a2, beginning with “Alpha,” ending with “Zulu,” and repeated without regard to the beginning of a new day. Identify the first resumed broadcast message with “Alpha” or the first assigned alphabet letter word in the event of a broadcast interruption of more than 12 hours.

2. Specific sequential portions of the alphabet may be assigned between facilities or an arrival and departure ATIS when designated by a letter of agreement or facility directive.

REFERENCE-

FAAO 7210.3, *Automatic Terminal Information Service (ATIS)*, Para 10-4-1.

b. The ATIS recording shall be reviewed for completeness, accuracy, speech rate, and proper enunciation before being transmitted.

c. Arrival and departure messages, when broadcast separately, need only contain information appropriate for that operation.

2-9-2. OPERATING PROCEDURES

Maintain an ATIS message that reflects the most current arrival and departure information.

a. Make a new recording when any of the following occur:

1. Upon receipt of any new official weather regardless of whether there is or is not a change in values.

2. When runway braking action reports are received that indicate runway braking is worse than that which is included in the current ATIS broadcast.

3. When there is a change in any other pertinent data, such as runway change, instrument approach in use, new or canceled NOTAMS/PIREPs/HIWAS update, etc.

b. When a pilot acknowledges that he/she has received the ATIS broadcast, controllers may omit those items contained in the broadcasts if they are current. Rapidly changing conditions will be issued by ATC, and the ATIS will contain the following:

EXAMPLE-

“Latest ceiling/visibility/altimeter/wind/(other conditions) will be issued by approach control/tower.”

c. Broadcast on all appropriate frequencies to advise aircraft of a change in the ATIS code/message.

d. Controllers shall ensure that pilots receive the most current pertinent information. Ask the pilot to confirm receipt of the current ATIS information if the pilot does not initially state the appropriate ATIS code. Controllers shall ensure that changes to pertinent operational information is provided after the initial confirmation of ATIS information is established. Issue the current weather, runway in use, approach information, and pertinent NOTAMS to pilots who are unable to receive the ATIS.

EXAMPLE-

“Verify you have information ALPHA.”

“Information BRAVO now current, visibility three miles.”

“Information CHARLIE now current, Ceiling 1500 Broken.”

“Information CHARLIE now current, advise when you have CHARLIE.”

2-9-3. CONTENT

Include the following in ATIS broadcast as appropriate:

a. Airport/facility name, phonetic letter code, time of weather sequence (UTC). Weather information consisting of wind direction and velocity, visibility, obstructions to vision, present weather, sky condition, temperature, dew point, altimeter, a density altitude advisory when appropriate and other pertinent remarks included in the official weather observation. Wind direction, velocity, and altimeter shall be reported from certified direct reading instruments. Temperature and dew point should be reported from certified direct reading sensors when available. Always include weather observation remarks of lightning, cumulonimbus, and towering cumulus clouds.

NOTE-

ASOS/AWOS is to be considered the primary source of wind direction, velocity, and altimeter data for weather observation purposes at those locations that are so equipped. The ASOS Operator Interface Device (OID) displays the magnetic wind as "MAG WND" in the auxiliary data location in the lower left-hand portion of the screen. Other OID displayed winds are true and are not to be used for operational purposes.

b. Man-Portable Air Defense Systems (MANPADS) alert and advisory. Specify the nature and location of threat or incident, whether reported or observed and by whom, time (if known), and notification to pilots to advise ATC if they need to divert.

EXAMPLE-

1. "MANPADS alert. Exercise extreme caution. MANPADS threat reported by TSA, Chicago area." "Advise on initial contact if you want to divert."

2. "MANPADS alert. Exercise extreme caution. MANPADS attack observed by tower one-half mile northwest of airfield at one-two-five-zero Zulu." "Advise on initial contact if you want to divert."

REFERENCE-

FAAO 7110.65, MANPADS Alert, Para 10-2-13.
FAAO 7210.3, Handling MANPADS Incidents, Para 2-1-9.

c. The ceiling/sky condition, visibility, and obstructions to vision may be omitted if the ceiling is above 5,000 feet and the visibility is more than 5 miles.

EXAMPLE-

A remark may be made, "The weather is better than five thousand and five."

d. Instrument/visual approach/s in use. Specify landing runway/s unless the runway is that to which the instrument approach is made.

e. Departure runway/s (to be given only if different from landing runway/s or in the instance of a "departure only" ATIS).

f. Taxiway closures which affect the entrance or exit of active runways, other closures which impact airport operations, other NOTAMs and PIREPs pertinent to operations in the terminal area. Inform pilots of where hazardous weather is occurring and how the information may be obtained. Include available information of known bird activity.

REFERENCE-

FAAO 7110.65, Bird Activity Information, Para 2-1-22

g. Runway braking action or friction reports when provided. Include the time of the report and a word describing the cause of the runway friction problem.

PHRASEOLOGY-

RUNWAY (number) MU (first value, second value, third value) AT (time), (cause).

EXAMPLE-

"Runway Two Seven, MU forty-two, forty-one, twenty-eight at one zero one eight Zulu, ice."

REFERENCE-

FAAO 7110.65, Braking Action Advisories, Para 3-3-5

h. Other optional information as local conditions dictate in coordination with ATC. This may include such items as VFR arrival frequencies, temporary airport conditions, LAHSO operations being conducted, or other perishable items that may appear only for a matter of hours or a few days on the ATIS message.

i. Low level wind shear/microburst when reported by pilots or is detected on a wind shear detection system.

REFERENCE-

FAAO 7110.65, Low Level Wind Shear/Microburst Advisories, Para 3-1-8

j. A statement which advises the pilot to read back instructions to hold short of a runway. The air traffic manager may elect to remove this requirement 60 days after implementation provided that removing the statement from the ATIS does not result in increased requests from aircraft for read back of hold short instructions.

k. Instructions for the pilot to acknowledge receipt of the ATIS message by informing the controller on initial contact.

EXAMPLE-

“Boston Tower Information Delta. One four zero zero Zulu. Wind two five zero at one zero. Visibility one zero. Ceiling

four thousand five hundred broken. Temperature three four. Dew point two eight. Altimeter three zero one zero. ILS-DME Runway Two Seven Approach in use. Departing Runway Two Two Right. Hazardous Weather Information for (geographical area) available on HIWAS, Flight Watch, or Flight Service Frequencies. Advise on initial contact you have Delta.”

Section 10. Team Position Responsibilities

2-10-1. EN ROUTE SECTOR TEAM POSITION RESPONSIBILITIES

a. En Route Sector Team Concept and Intent:

1. There are no absolute divisions of responsibilities regarding position operations. The tasks to be completed remain the same whether one, two, or three people are working positions within a sector. The team, as a whole, has responsibility for the safe and efficient operation of that sector.

2. The intent of the team concept is not to hold the team accountable for the action of individual members, in the event of an operational accident/incident.

b. *Terms.* The following terms will be used in en route facilities for the purpose of standardization:

1. *Sector.* The area of control responsibility (delegated airspace) of the en route sector team, and the team as a whole.

2. *Radar Position (R).* That position which is in direct communication with the aircraft and which uses radar information as the primary means of separation.

3. *Radar Associate (RA).* That position sometimes referred to as “D-Side” or “Manual Controller.”

4. *Radar Coordinator Position (RC).* That position sometimes referred to as “Coordinator,” “Tracker,” or “Handoff Controller” (En Route).

5. *Radar Flight Data (FD).* That position commonly referred to as “Assistant Controller” or “A-Side” position.

6. *Nonradar Position (NR).* That position which is usually in direct communication with the aircraft and which uses nonradar procedures as the primary means of separation.

c. Primary responsibilities of the En Route Sector Team Positions:

1. *Radar Position:*

- (a) Ensure separation.
- (b) Initiate control instructions.
- (c) Monitor and operate radios.

(d) Accept and initiate automated handoffs.

(e) Assist the radar associate position with nonautomated handoff actions when needed.

(f) Assist the radar associate position in coordination when needed.

(g) Scan radar display. Correlate with flight progress strip information or User Request Evaluation Tool (URET) data, as applicable.

(h) Ensure computer entries are completed on instructions or clearances you issue or receive.

(i) Ensure strip marking and/or URET entries are completed on instructions or clearances you issue or receive.

(j) Adjust equipment at radar position to be usable by all members of the team.

(k) The radar controller shall not be responsible for G/G communications when precluded by VSCS split functionality.

2. *Radar Associate Position:*

(a) Ensure separation.

(b) At URET facilities, use URET information to plan, organize, and expedite the flow of traffic.

(c) Initiate control instructions.

(d) Operate interphones.

(e) Accept and initiate nonautomated handoffs, and ensure radar position is made aware of the actions.

(f) Assist the radar position by accepting or initiating automated handoffs which are necessary for the continued smooth operation of the sector, and ensure that the radar position is made immediately aware of any action taken.

(g) Coordinate, including pointouts.

(h) Monitor radios when not performing higher priority duties.

(i) Scan flight progress strips and/or URET data. Correlate with radar data.

(j) Manage flight progress strips and/or URET flight data.

(k) Ensure computer entries are completed on instructions issued or received. Enter instructions

issued or received by the radar position when aware of those instructions.

(l) As appropriate, ensure strip marking and/or URET entries are completed on instructions issued or received, and record instructions issued or received by the radar position when aware of them.

(m) Adjust equipment at radar associate position to be usable by all members of the team.

(n) Where authorized, perform URET data entries to keep the activation status of designated URET Airspace Configuration Elements current.

3. Radar Coordinator Position:

(a) Perform interfacility/intrafacility/sector/position coordination of traffic actions.

(b) Advise the radar position and the radar associate position of sector actions required to accomplish overall objectives.

(c) Perform any of the functions of the en route sector team which will assist in meeting situation objectives.

(d) The RC controller shall not be responsible for monitoring or operating radios when precluded by VSCS split functionality.

NOTE-

The Radar Position has the responsibility for managing the overall sector operations, including aircraft separation and traffic flows. The Radar Coordinator Position assumes responsibility for managing traffic flows and the Radar Position retains responsibility for aircraft separation when the Radar Coordinator Position is staffed.

4. Radar Flight Data:

(a) Operate interphone.

(b) Assist Radar Associate Position in managing flight progress strips.

(c) Receive/process and distribute flight progress strips.

(d) Ensure flight data processing equipment is operational, except for URET capabilities.

(e) Request/receive and disseminate weather, NOTAMs, NAS status, traffic management, and Special Use Airspace status messages.

(f) Manually prepare flight progress strips when automation systems are not available.

(g) Enter flight data into computer.

(h) Forward flight data via computer.

(i) Assist facility/sector in meeting situation objectives.

5. En Route Nonradar Position:

(a) Ensure separation.

(b) Initiate control instructions.

(c) Monitor and operate radios.

(d) Accept and initiate transfer of control, communications, and flight data.

(e) Ensure computer entries are completed on instructions or clearances issued or received.

(f) Ensure strip marking is completed on instructions or clearances issued or received.

(g) Facilities utilizing nonradar positions may modify the standards contained in the radar associate, radar coordinator, and radar flight data sections to accommodate facility/sector needs, i.e., nonradar coordinator, nonradar data positions.

2-10-2. TERMINAL RADAR/NONRADAR TEAM POSITION RESPONSIBILITIES

a. Terminal Radar Team Concept and Intent:

1. There are no absolute divisions of responsibilities regarding position operations. The tasks to be completed remain the same whether one, two, or three people are working positions within a facility/sector. The team, as a whole, has responsibility for the safe and efficient operation of that facility/sector.

2. The intent of the team concept is not to hold the team accountable for the action of individual members in the event of an operational error/deviation.

b. Terms. The following terms will be used in terminal facilities for the purposes of standardization.

1. *Facility/Sector.* The area of control responsibility (delegated airspace) of the radar team, and the team as a whole.

2. Radar Position (R). That position which is in direct communication with the aircraft and which uses radar information as the primary means of separation.

3. Radar Associate Position (RA). That position commonly referred to as “Handoff Controller” or “Radar Data Controller.”

4. Radar Coordinator Position (RC). That position commonly referred to as “Coordinator,” “Tracker,” “Sequencer,” or “Overhead.”

5. Radar Flight Data (FD). That position commonly referred to as “Flight Data.”

6. Nonradar Position (NR). That position which is usually in direct communication with the aircraft and which uses nonradar procedures as the primary means of separation.

c. Primary Responsibilities of the Terminal Radar Team Positions:

1. Radar Position:

- (a) Ensure separation.
- (b) Initiate control instructions.
- (c) Monitor and operate radios.
- (d) Accept and initiate automated handoffs.
- (e) Assist the Radar Associate Position with nonautomated handoff actions when needed.
- (f) Assist the Radar Associate Position in coordination when needed.
- (g) Scan radar display. Correlate with flight progress strip information.
- (h) Ensure computer entries are completed on instructions or clearances you issue or receive.
- (i) Ensure strip marking is completed on instructions or clearances you issue or receive.
- (j) Adjust equipment at Radar Position to be usable by all members of the team.

2. Radar Associate Position:

- (a) Ensure separation.
- (b) Initiate control instructions.
- (c) Operate interphones.
- (d) Maintain awareness of facility/sector activities.

- (e) Accept and initiate nonautomated hand-offs.

- (f) Assist the Radar Position by accepting or initiating automated handoffs which are necessary for the continued smooth operation of the facility/sector and ensure that the Radar Position is made immediately aware of any actions taken.

- (g) Coordinate, including point outs.

- (h) Scan flight progress strips. Correlate with radar data.

- (i) Manage flight progress strips.

- (j) Ensure computer entries are completed on instructions issued or received, and enter instructions issued or received by the Radar Position when aware of those instructions.

- (k) Ensure strip marking is completed on instructions issued or received, and write instructions issued or received by the Radar Position when aware of them.

- (l) Adjust equipment at Radar Associate Position to be usable by all members of the Radar Team.

3. Radar Coordinator Position:

- (a) Perform interfacility/sector/position coordination of traffic actions.

- (b) Advise the Radar Position and the Radar Associate Position of facility/sector actions required to accomplish overall objectives.

- (c) Perform any of the functions of the Radar Team which will assist in meeting situation objectives.

NOTE—

The Radar Position has the responsibility of managing the overall sector operations, including aircraft separation and traffic flows. The Radar Coordinator Position assumes responsibility for managing traffic flows and the Radar Position retains responsibility for aircraft separation when the Radar Coordinator Position is staffed.

4. Radar Flight Data:

- (a) Operate interphones.

- (b) Process and forward flight plan information.

- (c) Compile statistical data.

- (d) Assist facility/sector in meeting situation objectives.

5. *Terminal Nonradar Position:*

- (a) Ensure separation.
- (b) Initiate control instructions.
- (c) Monitor and operate radios.
- (d) Accept and initiate transfer of control, communications and flight data.
- (e) Ensure computer entries are completed on instructions or clearances issued or received.
- (f) Ensure strip marking is completed on instructions or clearances issued or received.
- (g) Facilities utilizing nonradar positions may modify the standards contained in the radar associate, radar coordinator, and radar flight data sections to accommodate facility/sector needs, i.e. nonradar coordinator, nonradar data positions.

2-10-3. TOWER TEAM POSITION RESPONSIBILITIES

a. *Tower Team Concept and Intent:*

1. There are no absolute divisions of responsibilities regarding position operations. The tasks to be completed remain the same whether one, two, or three people are working positions within a tower cab. The team as a whole has responsibility for the safe and efficient operation of that tower cab.

2. The intent of the team concept is not to hold the team accountable for the action of individual members in the event of an operational error/deviation.

b. *Terms:* The following terms will be used in terminal facilities for the purpose of standardization.

1. *Tower Cab:* The area of control responsibility (delegated airspace and/or airport surface areas) of the tower team, and the team as a whole.

2. *Tower Position(s) (LC or GC):* That position which is in direct communications with the aircraft and ensures separation of aircraft in/on the area of jurisdiction.

3. *Tower Associate Position(s):* That position commonly referred to as “Local Assist,” “Ground Assist,” “Local Associate,” or “Ground Associate.”

4. *Tower Cab Coordinator Position (CC):* That position commonly referred to as “Coordinator.”

5. *Flight Data (FD):* That position commonly referred to as “Flight Data.”

6. *Clearance Delivery (CD):* That position commonly referred to as “Clearance.”

c. Primary responsibilities of the Tower Team Positions:

1. *Tower Position(s) (LC or GC):*

- (a) Ensure separation.
- (b) Initiate control instructions.
- (c) Monitor and operate communications equipment.
- (d) Utilize tower radar display(s).
- (e) Utilize alphanumerics.
- (f) Assist the Tower Associate Position with coordination.
- (g) Scan tower cab environment.
- (h) Ensure computer entries are completed for instructions or clearances issued or received.
- (i) Ensure strip marking is completed for instructions or clearances issued or received.
- (j) Process and forward flight plan information.
- (k) Perform any functions of the Tower Team which will assist in meeting situation objectives.

2. *Tower Associate Position(s):*

- (a) Ensure separation.
- (b) Operate interphones.
- (c) Maintain awareness of tower cab activities.
- (d) Utilize alphanumerics.
- (e) Utilize tower radar display(s).
- (f) Assist Tower Position by accepting/initiating coordination for the continued smooth operation of the tower cab and ensure that the Tower Position is made immediately aware of any actions taken.
- (g) Manage flight plan information.
- (h) Ensure computer entries are completed for instructions issued or received and enter instructions issued or received by a Tower Position.
- (i) Ensure strip marking is completed for instructions issued or received and enter instructions issued or received by a Tower Position.

3. *Tower Coordinator Position:*

(a) Perform interfacility/position coordination for traffic actions.

(b) Advise the tower and the Tower Associate Position(s) of tower cab actions required to accomplish overall objectives.

(c) Perform any of the functions of the Tower Team which will assist in meeting situation objectives.

NOTE-

The Tower Positions have the responsibility for aircraft separation and traffic flows. The Tower Coordinator Position assumes responsibility for managing traffic flows and the Tower Positions retain responsibility for aircraft separation when the Tower Coordinator Position is staffed.

4. *Flight Data:*

(a) Operate interphones.

(b) Process and forward flight plan information.

(c) Compile statistical data.

(d) Assist tower cab in meeting situation objectives.

(e) Observe and report weather information.

(f) Utilize alphanumerics.

5. *Clearance Delivery:*

(a) Operate communications equipment.

(b) Process and forward flight plan information.

(c) Issue clearances and ensure accuracy of pilot read back.

(d) Assist tower cab in meeting situation objectives.

(e) Operate tower equipment.

(f) Utilize alphanumerics.

NOTE-

The Tower Positions have the responsibility for aircraft separation and traffic flows. The Tower Coordinator Position assumes responsibility for managing traffic flows and the Tower Positions retain responsibility for aircraft separation when the Tower Coordinator Position is staffed.

Chapter 3. Airport Traffic Control– Terminal

Section 1. General

3–1–1. PROVIDE SERVICE

Provide airport traffic control service based only upon observed or known traffic and airport conditions.

NOTE–

When operating in accordance with CFRs, it is the responsibility of the pilot to avoid collision with other aircraft. However, due to the limited space around terminal locations, traffic information can aid pilots in avoiding collision between aircraft operating within Class B, Class C, or Class D surface areas and the terminal radar service areas, and transiting aircraft operating in proximity to terminal locations.

3–1–2. PREVENTIVE CONTROL

Provide preventive control service only to aircraft operating in accordance with a letter of agreement. When providing this service, issue advice or instructions only if a situation develops which requires corrective action.

NOTE–

Preventive control differs from other airport traffic control in that repetitious, routine approval of pilot action is eliminated. Controllers intervene only when they observe a traffic conflict developing.

3–1–3. USE OF ACTIVE RUNWAYS

The local controller has primary responsibility for operations conducted on the active runway and must control the use of those runways. Positive coordination and control is required as follows:

NOTE–

Exceptions may be authorized only as provided in para 1–1–9 Constraints Governing Supplements and Procedural Deviations, and FAAO 7210.3, Facility Operation and Administration, Use of Active Runways, para 10–1–7, where justified by extraordinary circumstances at specific locations.

REFERENCE–

*FAAO 7110.65, Constraints Governing Supplements and Procedural Deviations, Para 1–1–9
FAAO 7210.3, Use of Active Runways, Para 10–1–7.*

a. Ground control must obtain approval from local control before authorizing an aircraft or a vehicle to cross or use any portion of an active runway. The coordination shall include the point/intersection at the runway where the operation will occur.

PHRASEOLOGY–

CROSS (runway) AT (point/intersection).

b. When the local controller authorizes another controller to cross an active runway, the local controller shall verbally specify the runway to be crossed and the point/intersection at the runway where the operation will occur preceded by the word “cross.”

PHRASEOLOGY–

CROSS (runway) AT (point/intersection).

c. The ground controller shall advise the local controller when the coordinated runway operation is complete. This may be accomplished verbally or through visual aids as specified by a facility directive.

d. **USA/USAF/USN NOT APPLICABLE.** Authorization for aircraft/vehicles to taxi/proceed on or along an active runway, for purposes other than crossing, shall be provided via direct communications on the appropriate local control frequency. This authorization may be provided on the ground control frequency after coordination with local control is completed for those operations specifically described in a facility directive.

NOTE–

The USA, USAF, and USN establish local operating procedures in accordance with, respectively, USA, USAF, and USN directives.

e. The local controller shall coordinate with the ground controller before using a runway not previously designated as active.

REFERENCE–

FAAO 7110.65, Coordination Between Local and Ground Controllers, Para 3–1–4

3-1-4. COORDINATION BETWEEN LOCAL AND GROUND CONTROLLERS

Local and ground controllers shall exchange information as necessary for the safe and efficient use of airport runways and movement areas. This may be accomplished via verbal means, flight progress strips, other written information, or automation displays. As a minimum, provide aircraft identification and applicable runway/intersection/taxiway information as follows:

a. Ground control shall notify local control when a departing aircraft has been taxied to a runway other than one previously designated as active.

REFERENCE-

FAAO 7110.65, *Use of Active Runways*, Para 3-1-3
FAAO 7210.3, *Selecting Active Runways*, Para 10-1-6.

b. Ground control shall notify local control of any aircraft taxied to an intersection for takeoff, unless departure from that intersection is specifically designated via prior coordination or facility directive as the standard operating procedure for the runway to be used. When standard procedures require departures to use a specific intersection, ground control shall notify local control when aircraft are taxied to other portions of the runway for departure.

REFERENCE-

FAAO 7110.65, *Wake Turbulence Separation for Intersection Departures*, Para 3-9-7

c. When the runways in use for landing/departing aircraft are not visible from the tower or the aircraft using them are not visible on radar, advise the local/ground controller of the aircraft's location before releasing the aircraft to the other controller.

3-1-5. VEHICLES/EQUIPMENT/PERSONNEL ON RUNWAYS

a. Ensure that the runway to be used is free of all known ground vehicles, equipment, and personnel before a departing aircraft starts takeoff or a landing aircraft crosses the runway threshold.

b. Vehicles, equipment, and personnel in direct communications with the control tower may be authorized to operate up to the edge of an active runway surface when necessary. Provide advisories as specified in para 3-1-6, Traffic Information, and para 3-7-5, Precision Approach Critical Area, as appropriate.

PHRASEOLOGY-

PROCEED AS REQUESTED; AND IF NECESSARY, (additional instructions or information).

NOTE-

Establishing hold lines/signs is the responsibility of the airport manager. Standards for surface measurements, markings, and signs are contained in the following Advisory Circulars; AC 150/5300-13, Airport Design; AC 150/5340-1, Standards for Airport Markings, and AC 150/5340-18, Standards for Airport Sign Systems. The operator is responsible to properly position the aircraft, vehicle, or equipment at the appropriate hold line/sign or designated point. The requirements in para 3-1-12 Visually Scanning Runways, remain valid as appropriate.

REFERENCE-

FAAO 7110.65, *Runway Proximity*, Para 3-7-4
FAAO 7110.65, *Touch-and-Go or Stop-and-Go or Low Approach*, Para 3-8-2
FAAO 7110.65, *Altitude Restricted Low Approach*, Para 3-10-10
AC 150/5300-13, *Airport Design*.
AC 150/5340-1G, *Standards for Airport Markings*.
14 CFR Section 91.129, *Operations in Class D Airspace*.
AIM, *Obstruction Lights*, Para 2-2-3.
P/CG Term- *Runway in Use/Active Runway/Duty Runway*.

3-1-6. TRAFFIC INFORMATION

a. Describe vehicles, equipment, or personnel on or near the movement area in a manner which will assist pilots in recognizing them.

EXAMPLE-

*"Mower left of runway two seven."
"Trucks crossing approach end of runway two five."
"Workman on taxiway Bravo."
"Aircraft left of runway one eight."*

b. Describe the relative position of traffic in an easy to understand manner, such as "to your right" or "ahead of you."

EXAMPLE-

*"Traffic, U.S. Air MD-Eighty on downwind leg to your left."
"King Air inbound from outer marker on straight-in approach to runway one seven."*

c. When using a CTRD, you may issue traffic advisories using the standard radar phraseology prescribed in para 2-1-21, Traffic Advisories.

REFERENCE-

FAAO 7110.65, *Altitude Restricted Low Approach*, Para 3-10-10

3-1-7. POSITION DETERMINATION

Determine the position of an aircraft before issuing taxi instructions or takeoff clearance.

NOTE-

The aircraft's position may be determined visually by the controller, by pilots, or through the use of the ASDE.

3-1-8. LOW LEVEL WIND SHEAR/MICROBURST ADVISORIES

a. When low level wind shear/microburst is reported by pilots, Integrated Terminal Weather System (ITWS), or detected on wind shear detection systems such as LLWAS NE++, LLWAS-RS, WSP, or TDWR, controllers shall issue the alert to all arriving and departing aircraft. Continue the alert to aircraft until it is broadcast on the ATIS and pilots indicate they have received the appropriate ATIS code. A statement shall be included on the ATIS for 20 minutes following the last report or indication of the wind shear/microburst.

REFERENCE-

FAAO 7110.65, PIREP Information, Para 2-6-3
FAAO 7110.65, Content, Para 2-9-3
FAAO 7110.65, Landing Information, Para 3-10-1

PHRASEOLOGY-

LOW LEVEL WIND SHEAR (or MICROBURST, as appropriate) ADVISORIES IN EFFECT.

b. At facilities without ATIS, ensure that wind shear/microburst information is broadcast to all arriving and departing aircraft for 20 minutes following the last report or indication of wind shear/microburst.

1. At locations equipped with LLWAS, the local controller shall provide wind information as follows:

NOTE-

The LLWAS is designed to detect low level wind shear conditions around the periphery of an airport. It does not detect wind shear beyond that limitation.

REFERENCE-

FAAO 7210.3, Low Level Wind Shear/Microburst Detection Systems, Para 10-3-3.

(a) If an alert is received, issue the airport wind and the displayed field boundary wind.

PHRASEOLOGY-

WIND SHEAR ALERT. AIRPORT WIND (direction) AT (velocity). (Location of sensor) BOUNDARY WIND (direction) AT (velocity).

(b) If multiple alerts are received, issue an advisory that there are wind shear alerts in two/several/all quadrants. After issuing the advisory, issue the airport wind in accordance with para 3-9-1, Departure Information, followed by the field boundary wind most appropriate to the aircraft operation.

PHRASEOLOGY-

WIND SHEAR ALERTS TWO/SEVERAL/ALL QUADRANTS. AIRPORT WIND (direction) AT (velocity). (Location of sensor) BOUNDARY WIND (direction) AT (velocity).

(c) If requested by the pilot, issue specific field boundary wind information even though the LLWAS may not be in alert status.

NOTE-

The requirements for issuance of wind information remain valid as appropriate under this paragraph, para 3-9-1 Departure Information and para 3-10-1 Landing Information.

2. Wind shear detection systems, including TDWR, WSP, LLWAS NE++ and LLWAS-RS provide the capability of displaying microburst alerts, wind shear alerts, and wind information oriented to the threshold or departure end of a runway. When detected, the associated ribbon display allows the controller to read the displayed alert without any need for interpretation.

(a) If a wind shear or microburst alert is received for the runway in use, issue the alert information for that runway to arriving and departing aircraft as it is displayed on the ribbon display.

PHRASEOLOGY-

(Runway) (arrival/departure) WIND SHEAR/MICROBURST ALERT, (windspeed) KNOT GAIN/LOSS, (location).

EXAMPLE-

17A MBA 40K - 3MF

PHRASEOLOGY-

RUNWAY 17 ARRIVAL MICROBURST ALERT 40 KNOT LOSS 3 MILE FINAL.

EXAMPLE-

17D WSA 25K+ 2MD

PHRASEOLOGY-

RUNWAY 17 DEPARTURE WIND SHEAR ALERT 25 KNOT GAIN 2 MILE DEPARTURE.

(b) If requested by the pilot or deemed appropriate by the controller, issue the displayed wind information oriented to the threshold or departure end of the runway.

PHRASEOLOGY-

(Runway) DEPARTURE/THRESHOLD WIND (direction) AT (velocity).

(c) LLWAS NE++ or LLWAS–RS may detect a possible wind shear/microburst at the edge of the system but may be unable to distinguish between a wind shear and a microburst. A wind shear alert message will be displayed, followed by an asterisk, advising of a possible wind shear outside of the system network.

NOTE–

LLWAS NE++ when associated with TDWR can detect wind shear/microbursts outside the network if the TDWR fails.

PHRASEOLOGY–

(Appropriate wind or alert information) POSSIBLE WIND SHEAR OUTSIDE THE NETWORK.

(d) If unstable conditions produce multiple alerts, issue an advisory of multiple wind shear/microburst alerts followed by specific alert or wind information most appropriate to the aircraft operation.

PHRASEOLOGY–

MULTIPLE WIND SHEAR/MICROBURST ALERTS (specific alert or wind information).

(e) The LLWAS NE++ and LLWAS–RS are designed to operate with as many as 50 percent of the total sensors inoperative. When all three remote sensors designated for a specific runway arrival or departure wind display line are inoperative then the LLWAS NE++ and LLWAS–RS for that runway arrival/departure shall be considered out of service. When a specific runway arrival or departure wind display line is inoperative and wind shear/microburst activity is likely; (e.g.; frontal activity, convective storms, PIREPs), a statement shall be included on the ATIS, “WIND SHEAR AND MICROBURST INFORMATION FOR RUNWAY (runway number) ARRIVAL/DEPARTURE NOT AVAILABLE.”

NOTE–

The geographic situation display (GSD) is a supervisory planning tool and is not intended to be a primary tool for microburst or wind shear.

3–1–9. USE OF TOWER RADAR DISPLAYS

a. Uncertified tower display workstations shall be used only as an aid to assist controllers in visually locating aircraft or in determining their spatial relationship to known geographical points. Radar services and traffic advisories are not to be provided

using uncertified tower display workstations. General information may be given in an easy to understand manner, such as “to your right” or “ahead of you.”

EXAMPLE–

“Follow the aircraft ahead of you passing the river at the stacks.” “King Air passing left to right.”

REFERENCE–

FAAO 7210.3, Functional Use of Certified Tower Radar Displays, Para 10–5–3.

b. Local controllers may use certified tower radar displays for the following purposes:

1. To determine an aircraft’s identification, exact location, or spatial relationship to other aircraft.

NOTE–

This authorization does not alter visual separation procedures. When employing visual separation, the provisions of para 7–2–1 Visual Separation, apply unless otherwise authorized by AAT–1.

REFERENCE–

FAAO 7110.65, Primary Radar Identification Methods, Para 5–3–2

FAAO 7110.65, Beacon Identification Methods, Para 5–3–3

FAAO 7110.65, Terminal Automation Systems Identification Methods, Para 5–3–4

2. To provide aircraft with radar traffic advisories.

3. To provide a direction or suggested headings to VFR aircraft as a method for radar identification or as an advisory aid to navigation.

PHRASEOLOGY–

(Identification), PROCEED (direction)–BOUND, (other instructions or information as necessary),

or

(identification), SUGGESTED HEADING (degrees), (other instructions as necessary).

NOTE–

It is important that the pilot be aware of the fact that the directions or headings being provided are suggestions or are advisory in nature. This is to keep the pilot from being inadvertently misled into assuming that radar vectors (and other associated radar services) are being provided when, in fact, they are not.

4. To provide information and instructions to aircraft operating within the surface area for which the tower has responsibility.

EXAMPLE–

“TURN BASE LEG NOW.”

NOTE-

Unless otherwise authorized, tower radar displays are intended to be an aid to local controllers in meeting their responsibilities to the aircraft operating on the runways or within the surface area. They are not intended to provide radar benefits to pilots except for those accrued through a more efficient and effective local control position. In addition, local controllers at nonapproach control towers must devote the majority of their time to visually scanning the runways and local area; an assurance of continued positive radar identification could place distracting and operationally inefficient requirements upon the local controller. Therefore, since the requirements of para 5-3-1 Application, cannot be assured, the radar functions prescribed above are not considered to be radar services and pilots should not be advised of being in "radar contact."

c. Additional functions may be performed provided the procedures have been reviewed and authorized by appropriate management levels.

REFERENCE-

FAAO 7110.65, *Minima*, Para 5-5-4

3-1-10. OBSERVED ABNORMALITIES

When requested by a pilot or when you deem it necessary, inform an aircraft of any observed abnormal aircraft condition.

PHRASEOLOGY-

(Item) APPEAR/S (observed condition).

EXAMPLE-

"Landing gear appears up."

"Landing gear appears down and in place."

"Rear baggage door appears open."

3-1-11. SURFACE AREA RESTRICTIONS

a. If traffic conditions permit, approve a pilot's request to cross Class C or Class D surface areas or exceed the Class C or Class D airspace speed limit. Do not, however, approve a speed in excess of 250 knots (288 mph) unless the pilot informs you a higher minimum speed is required.

NOTE-

14 CFR Section 91.117 permits speeds in excess of 250 knots (288 mph) when so required or recommended in the airplane flight manual or required by normal military operating procedures.

REFERENCE-

FAAO 7110.65, *Surface Areas*, Para 2-1-16

b. Do not approve a pilot's request or ask a pilot to conduct unusual maneuvers within surface areas of Class B, C, or D airspace if they are not essential to the performance of the flight.

EXCEPTION. A pilot's request to conduct aerobatic practice activities may be approved, when operating in accordance with a letter of agreement, and the activity will have no adverse affect on safety of the air traffic operation or result in a reduction of service to other users.

REFERENCE-

FAAO 7210.3, *Aerobatic Practice Areas*, Para 5-4-7.

NOTE-

These unusual maneuvers include unnecessary low passes, unscheduled flybys, practice instrument approaches to altitudes below specified minima (unless a landing or touch-and-go is to be made), or any so-called "buzz jobs" wherein a flight is conducted at a low altitude and/or a high rate of speed for thrill purposes. Such maneuvers increase hazards to persons and property and contribute to noise complaints.

3-1-12. VISUALLY SCANNING RUNWAYS

a. Local controllers shall visually scan runways to the maximum extent possible.

b. Ground control shall assist local control in visually scanning runways, especially when runways are in close proximity to other movement areas.

3-1-13. ESTABLISHING TWO-WAY COMMUNICATIONS

Pilots are required to establish two-way radio communications before entering the Class D airspace. If the controller responds to a radio call with, "(a/c call sign) standby," radio communications have been established and the pilot can enter the Class D airspace. If workload or traffic conditions prevent immediate provision of Class D services, inform the pilot to remain outside the Class D airspace until conditions permit the services to be provided.

PHRASEOLOGY-

(A/c call sign) REMAIN OUTSIDE DELTA AIRSPACE AND STANDBY.

REFERENCE-

FAAO 7110.65, *Visual Separation*, Para 7-2-1

3-1-14. GROUND OPERATIONS WHEN VOLCANIC ASH IS PRESENT

When volcanic ash is present on the airport surface, and to the extent possible:

- a. Avoid requiring aircraft to come to a full stop while taxiing.
- b. Provide for a rolling takeoff for all departures.

NOTE-

When aircraft begin a taxi or takeoff roll on ash contaminated surfaces, large amounts of volcanic ash will again become airborne. This newly airborne ash will significantly reduce visibility and will be ingested by the engines of following aircraft.

REFERENCE-

AIM, Flight Operations in Volcanic Ash, Para 7-5-8.

Section 2. Visual Signals

3-2-1. LIGHT SIGNALS

Use ATC light signals from TBL 3-2-1 to control aircraft and the movement of vehicles, equipment, and personnel on the movement area when radio communications cannot be employed.

REFERENCE-

FAAO 7110.65, *Altitude Restricted Low Approach, Para 3-10-10*
FAAO 7210.3., *Letters of Agreement, Para 4-3-1.*

3-2-2. WARNING SIGNAL

Direct a general warning signal, alternating red and green, to aircraft or vehicle operators, as appropriate, when:

NOTE-

The warning signal is not a prohibitive signal and can be followed by any other light signal, as circumstances permit.

- a. Aircraft are converging and a collision hazard exists.
- b. Mechanical trouble exists of which the pilot might not be aware.
- c. Other hazardous conditions are present which call for intensified pilot or operator alertness. These conditions may include obstructions, soft field, ice on the runway, etc.

3-2-3. RECEIVER-ONLY ACKNOWLEDGMENT

To obtain acknowledgment from an aircraft equipped with receiver only, request the aircraft to do the following:

a. *Fixed-wing aircraft:*

1. Between sunrise and sunset:

(a) Move ailerons or rudders while on the ground.

(b) Rock wings while in flight.

2. Between sunset and sunrise: Flash navigation or landing lights.

b. *Helicopters:*

1. Between sunrise and sunset:

(a) While hovering, either turn the helicopter toward the controlling facility and flash the landing light or rock the tip path plane.

(b) While in flight, either flash the landing light or rock the tip path plane.

2. Between sunset and sunrise: Flash landing light or search light.

TBL 3-2-1
ATC Light Signals

Meaning			
Color and type of signal	Aircraft on the ground	Aircraft in flight	Movement of vehicles, equipment and personnel
Steady green	Cleared for takeoff	Cleared to land	Cleared to cross; proceed; go
Flashing green	Cleared to taxi	Return for landing (to be followed by steady green at the proper time)	Not applicable
Steady red	Stop	Give way to other aircraft and continue circling	Stop
Flashing red	Taxi clear of landing area or runway in use	Airport unsafe- Do not land	Clear the taxiway/runway
Flashing white	Return to starting point on airport	Not applicable	Return to starting point on airport
Alternating red and green	General Warning Signal- Exercise Extreme Caution	General Warning Signal- Exercise Extreme Caution	General Warning Signal- Exercise Extreme Caution

Section 3. Airport Conditions

3-3-1. LANDING AREA CONDITION

If you observe or are informed of any condition which affects the safe use of a landing area:

NOTE-

1. The airport management/military operations office is responsible for observing and reporting the condition of the landing area.

2. It is the responsibility of the agency operating the airport to provide the tower with current information regarding airport conditions.

3. A disabled aircraft on a runway, after occupants are clear, is normally handled by flight standards and airport management/military operations office personnel in the same manner as any obstruction; e.g., construction equipment.

a. Relay the information to the airport manager/military operations office concerned.

b. Copy verbatim any information received and record the name of the person submitting it.

c. Confirm information obtained from other than authorized airport or FAA personnel unless this function is the responsibility of the military operations office.

NOTE-

Civil airport managers are required to provide a list of airport employees who are authorized to issue information concerning conditions affecting the safe use of the airport.

d. If you are unable to contact the airport management or operator, issue a NOTAM publicizing an unsafe condition and inform the management or operator as soon as practicable.

EXAMPLE-

“DISABLED AIRCRAFT ON RUNWAY.”

NOTE-

1. Legally, only the airport management/military operations office can close a runway.

2. Military controllers are not authorized to issue NOTAMs. It is the responsibility of the military operations office.

e. Issue to aircraft only factual information, as reported by the airport management concerning the condition of the runway surface, describing the accumulation of precipitation.

EXAMPLE-

“ALL RUNWAYS COVERED BY COMPACTED SNOW SIX INCHES DEEP.”

REFERENCE-

FAAO 7110.65, Airport Conditions, Para 4-7-12

3-3-2. CLOSED/UNSAFE RUNWAY INFORMATION

If an aircraft requests to takeoff, land, or touch-and-go on a closed or unsafe runway, inform the pilot the runway is closed or unsafe, and

a. If the pilot persists in his/her request, quote him/her the appropriate parts of the NOTAM applying to the runway and inform him/her that a clearance cannot be issued.

b. Then, if the pilot insists and in your opinion the intended operation would not adversely affect other traffic, inform him/her that the operation will be at his/her own risk.

PHRASEOLOGY-

RUNWAY (runway number) CLOSED/UNSAFE.

If appropriate, (quote NOTAM information),

UNABLE TO ISSUE DEPARTURE/LANDING/TOUCH-AND-GO CLEARANCE.

DEPARTURE/LANDING/TOUCH-AND-GO WILL BE AT YOUR OWN RISK.

c. Except as permitted by para 4-8-7, Side-step Maneuver, where parallel runways are served by separate ILS/MLS systems and one of the runways is closed, the ILS/MLS associated with the closed runway should not be used for approaches unless not using the ILS/MLS would have an adverse impact on the operational efficiency of the airport.

REFERENCE-

FAAO 7110.65, Landing Clearance, Para 3-10-5

FAAO 7110.65, Airport Conditions, Para 4-7-12

3-3-3. TIMELY INFORMATION

Issue airport condition information necessary for an aircraft's safe operation in time for it to be useful to the pilot. Include the following, as appropriate:

a. Construction work on or immediately adjacent to the movement area.

b. Rough portions of the movement area.

- c. Braking conditions caused by ice, snow, slush, or water.
- d. Snowdrifts or piles of snow on or along the edges of the area and the extent of any plowed area.
- e. Parked aircraft on the movement area.
- f. Irregular operation of part or all of the airport lighting system.
- g. Volcanic ash on any airport surface area and whether the ash is wet or dry (if known).

NOTE-

Braking action on wet ash may be degraded. Dry ash on the runway may necessitate minimum use of reverse thrust.

- h. Other pertinent airport conditions.

REFERENCE-

FAAO 7110.65, *Airport Conditions, Para 4-7-12*
 FAAO 7110.65, *Reporting Essential Flight Information, Para 2-1-9*
 FAAO 7110.65, *Altitude Restricted Low Approach, Para 3-10-10*

3-3-4. BRAKING ACTION

Furnish quality of braking action, as received from pilots or the airport management, to all aircraft as follows:

- a. Describe the quality of braking action using the terms “good,” “fair,” “poor,” “nil,” or a combination of these terms. If the pilot or airport management reports braking action in other than the foregoing terms, ask him/her to categorize braking action in these terms.

NOTE-

The term “nil” is used to indicate bad or no braking action.

- b. Include type of aircraft or vehicle from which the report is received.

EXAMPLE-

“Braking action fair to poor, reported by a heavy D-C Ten.”

“Braking action poor, reported by a Boeing Seven Twenty-Seven.”

- c. If the braking action report affects only a portion of a runway, obtain enough information from the pilot or airport management to describe the braking action in terms easily understood by the pilot.

EXAMPLE-

“Braking action poor first half of runway, reported by a Lockheed Ten Eleven.”

“Braking action poor beyond the intersection of runway two seven, reported by a Boeing Seven Twenty-Seven.”

NOTE-

Descriptive terms, such as the first or the last half of the runway, should normally be used rather than landmark descriptions, such as opposite the fire station, south of a taxiway, etc. Landmarks extraneous to the landing runway are difficult to distinguish during low visibility, at night, or anytime a pilot is busy landing an aircraft.

- d. Furnish runway friction measurement readings/values as received from airport management to aircraft as follows:

1. Furnish information as received from the airport management to pilots on the ATIS at locations where friction measuring devices, such as MU-Meter, Saab Friction Tester (SFT), and Skiddometer are in use only when the MU values are 40 or less. Use the runway followed by the MU number for each of the three runway segments, time of report, and a word describing the cause of the runway friction problem. Do not issue MU values when all three segments of the runway have values reported greater than 40.

EXAMPLE-

“Runway two seven, MU forty-two, forty-one, twenty-eight at one zero one eight Zulu, ice.”

2. Issue the runway surface condition and/or the Runway Condition Reading (RCR), if provided, to all USAF and ANG aircraft. Issue the RCR to other aircraft upon pilot request.

EXAMPLE-

“Ice on runway, RCR zero five, patchy.”

NOTE-

1. USAF has established RCR procedures for determining the average deceleration readings of runways under conditions of water, slush, ice, or snow. The use of the RCR code is dependent upon the pilot’s having a “stopping capability chart” specifically applicable to his/her aircraft.

2. USAF offices furnish RCR information at airports serving USAF and ANG aircraft.

REFERENCE-

FAAO 7110.65, *Airport Conditions, Para 4-7-12*
 FAAO 7110.65, *Braking Action Advisories, Para 3-3-5*

3-3-5. BRAKING ACTION ADVISORIES

- a. When runway braking action reports are received from pilots or the airport management which include the terms “poor” or “nil” or whenever weather conditions are conducive to deteriorating or rapidly changing runway conditions, include on the ATIS broadcast the statement “Braking Action Advisories are in effect.”

REFERENCE-

FAAO 7210.3, *Automatic Terminal Information Service (ATIS)*, Para 10-4-1.

b. During the time Braking Action Advisories are in effect, take the following action:

1. Issue the latest braking action report for the runway in use to each arriving and departing aircraft early enough to be of benefit to the pilot. When possible, include reports from heavy jet aircraft when the arriving or departing aircraft is a heavy jet.

2. If no report has been received for the runway of intended use, issue an advisory to that effect.

PHRASEOLOGY-

NO BRAKING ACTION REPORTS RECEIVED FOR RUNWAY (runway number).

3. Advise the airport management that runway braking action reports of “poor” or “nil” have been received.

REFERENCE-

FAAO 7210.3, *Letters of Agreement*, Para 4-3-1.

4. Solicit PIREPs of runway braking action.

REFERENCE-

FAAO 7110.65, *PIREP Information*, Para 2-6-3

c. Include runway friction measurement/values received from airport management on the ATIS. Furnish the information when requested by the pilot in accordance with para 3-3-4, Braking Action.

REFERENCE-

FAAO 7110.65, *Content*, Para 2-9-3

FAAO 7110.65, *Departure Information*, Para 3-9-1

FAAO 7110.65, *Landing Information*, Para 3-10-1

FAAO 7110.65, *Airport Conditions*, Para 4-7-12

3-3-6. ARRESTING SYSTEM OPERATION

a. For normal operations, arresting systems remotely controlled by ATC shall remain in the retracted or down position.

NOTE-

1. *USN- Runway Arresting Gear- barriers are not operated by ATC personnel. Readiness/rigging of the equipment is the responsibility of the operations department.*

2. *A request to raise a barrier or hook cable means the barrier or cable on the departure end of the runway. If an approach end engagement is required, the pilot or military authority will specifically request that the approach end cable be raised.*

REFERENCE-

FAAO 7610.4, *Chapter 9, Section 3. Aircraft Arresting System, Single Frequency Approach (SFA), Simulated Flameout (SFO)/Emergency Landing Pattern (ELP) Operations, Celestial Navigation (CELNAV) Training*, Para 9-3-1 through Para 9-3-8.

b. Raise aircraft arresting systems whenever:

1. Requested by a pilot.

NOTE-

The standard emergency phraseology for a pilot requesting an arresting system to be raised for immediate engagement is:

“BARRIER – BARRIER – BARRIER”

or

“CABLE – CABLE – CABLE.”

2. Requested by military authority; e.g., airfield manager, supervisor of flying, mobile control officer, etc.

NOTE-

USAF. Web barriers at the departure end of the runway may remain in the up position when requested by the senior operational commander. The IFR Enroute Supplement and AP-1 will describe specific barrier configuration. ATC will advise transient aircraft of the barrier configuration using the phraseology in subpara c, below.

3. A military jet aircraft is landing with known or suspected radio failure or conditions (drag chute/hydraulic/electrical failure, etc.) that indicate an arresting system may be needed. Exceptions are authorized for military aircraft which cannot engage an arresting system (C-9, C-141, C-5, T-39, etc.) and should be identified in a letter of agreement and/or appropriate military directive.

c. When requested by military authority due to freezing weather conditions or malfunction of the activating mechanism, the barrier/cable may remain in a raised position provided aircraft are advised.

PHRASEOLOGY-

YOUR DEPARTURE/LANDING WILL BE TOWARD/OVER A RAISED BARRIER/CABLE ON RUNWAY (number), (location, distance, as appropriate).

d. Inform civil and U.S. Army aircraft whenever rubber supported cables are in place at the approach end of the landing runway, and include the distance of the cables from the threshold. This information may be omitted if it is published in the “Notices to Airmen” publication/DOD FLIP.

EXAMPLE-

“Runway One Four arresting cable one thousand feet from threshold.”

e. When arresting system operation has been requested, inform the pilot of the indicated barrier/cable position.

PHRASEOLOGY-

(Identification), BARRIER/CABLE INDICATES UP/DOWN. CLEARED FOR TAKEOFF/TO LAND.

f. Time permitting, advise pilots of the availability of all arresting systems on the runway in question when a pilot requests barrier information.

g. If an aircraft engages a raised barrier/cable, initiate crash alarm procedures immediately.

h. For preplanned practice engagements not associated with emergencies, crash alarm systems need not be activated if, in accordance with local military operating procedures, all required notifications are made before the practice engagement.

REFERENCE-

FAAO 7110.65, Airport Conditions, Para 4-7-12

3-3-7. FAR FIELD MONITOR (FFM) REMOTE STATUS UNIT

a. Background.

1. To meet the demand for more facilities capable of operating under CAT III weather, Type II equipment is being upgraded to Integrity Level 3. This integrity level will support operations which place a high degree of reliance on ILS guidance for positioning through touchdown.

2. Installation of the FFM remote status indicating units is necessary to attain the integrity necessary to meet internationally agreed upon reliability values in support of CAT III operations on Type II ILS equipment. The remote status indicating unit used in conjunction with Type II equipment adds a third integrity test; thereby, producing an approach aid which has integrity capable of providing Level 3 service.

3. The remote status sensing unit, when installed in the tower cab, will give immediate indications of localizer out-of-tolerance conditions. The alarm in the FFM remote status sensing unit indicates an inoperative or an out-of-tolerance localizer signal; e.g., the course may have shifted due

to equipment malfunction or vehicle/aircraft encroachment into the critical area.

b. Procedures.

1. Operation of the FFM remote sensing unit will be based on the prevailing weather. The FFM remote sensing unit shall be operational when the weather is below CAT I ILS minimums.

2. When the weather is less than that required for CAT I operations, the GRN-27 FFM remote status sensing unit shall be set at:

(a) "CAT II" when the RVR is less than 2,400 feet.

(b) "CAT III" when the RVR is less than 1,200 feet.

3. When the remote status unit indicates that the localizer FFM is in alarm (aural warning following the preset delay) and:

(a) The aircraft is outside the middle marker (MM), check for encroachment those portions of the critical area that can be seen from the tower. It is understood that the entire critical area may not be visible due to low ceilings and poor visibility. The check is strictly to determine possible causal factors for the out-of-tolerance situation. If the alarm has not cleared prior to the aircraft's arriving at the MM, immediately issue an advisory that the FFM remote status sensing unit indicates the localizer is unreliable.

(b) The aircraft is between the MM and the inner marker (IM), immediately issue an advisory that the FFM remote status sensing unit indicates the localizer is unreliable.

PHRASEOLOGY-

CAUTION, MONITOR INDICATES RUNWAY (number) LOCALIZER UNRELIABLE.

(c) The aircraft has passed the IM, there is no action requirement. Although the FFM has been modified with filters which dampen the effect of false alarms, you may expect alarms when aircraft are located between the FFM and the localizer antenna either on landing or on takeoff.

REFERENCE-

FAAO 7110.65, Airport Conditions, Para 4-7-12

Section 4. Airport Lighting

3-4-1. EMERGENCY LIGHTING

Whenever you become aware that an emergency has or will occur, take action to provide for the operation of all appropriate airport lighting aids as required.

REFERENCE-
FAAO 7110.65, *Lighting Requirements, Para 10-4-2*

3-4-2. RUNWAY END IDENTIFIER LIGHTS

When separate on-off controls are provided, operate runway end identifier lights:

- a. When the associated runway lights are lighted. Turn the REIL off after:
 - 1. An arriving aircraft has landed.
 - 2. A departing aircraft has left the traffic pattern area.
 - 3. It is determined that the lights are of no further use to the pilot.
- b. As required by facility directives to meet local conditions.
- c. As requested by the pilot.
- d. Operate intensity setting in accordance with the values in TBL 3-4-1 except as prescribed in subparas b and c above.

TBL 3-4-1
REIL Intensity Setting-Three Step System

Settings	Visibility	
	Day	Night
3	Less than 2 miles	Less than 1 mile
2	2 to 5 miles inclusive	1 to but not including 3 miles
1	When requested	3 miles or more

3-4-3. VISUAL APPROACH SLOPE INDICATORS (VASI)

VASI systems with remote on-off switching shall be operated when they serve the runway in use and where intensities are controlled in accordance with TBL 3-4-2 and TBL 3-4-3 except:

- a. As required by facility directives to meet local conditions.

- b. As required by the pilot.

TBL 3-4-2
VASI Intensity Setting-Two Step System

Step	Period/Condition
High	Day-Sunrise to sunset.
Low	Night-Sunset to sunrise.

TBL 3-4-3
VASI Intensity Setting-Three Step System

Step	Period/Condition
High	Day-Sunrise to sunset.
Medium	Twilight-From sunset to 30 minutes after sunset and from 30 minutes before sunrise to sunrise,* and during twilight in Alaska.
Low	Night-Sunset to sunrise.

*During a 1 year period, twilight may vary 26 to 43 minutes between 25 and 49N latitude.

NOTE-
The basic FAA standard for VASI systems permits independent operation by means of photoelectric device. This system has no on-off control feature and is intended for continuous operation. Other VASI systems in use include those that are operated remotely from the control tower. These systems may consist of either a photoelectric intensity control with only an on-off switch, a two step intensity system, or a three step intensity system.

REFERENCE-
FAAO 7210.3, *Visual Approach Slope Indicator (VASI) Systems, Para 10-6-5.*
FAAO 6850.2, *Visual Guidance Lighting Systems.*

3-4-4. PRECISION APPROACH PATH INDICATORS (PAPI)

PAPI systems with remote on-off switching shall be operated when they serve the runway in use and where intensities are controlled in accordance with TBL 3-4-4 except:

- a. As required by local facility directives to meet local conditions.
- b. As requested by the pilot.

NOTE-
The basic FAA standard for PAPI systems permits independent operation by means of photoelectric device. This system has no on-off control feature and is intended for continuous operation. Other PAPI systems in use include those that are operated remotely from the control

tower. These systems may consist of either a photoelectric intensity control with only an on-off switch, or a five-step intensity system.

REFERENCE-
FAAO 6850.2, *Visual Guidance Lighting Systems*.

TBL 3-4-4

PAPI Intensity Setting – Five Step System

Step	Period/Condition
5	On Pilot Request
4	Day – Sunrise to sunset
3	Night – Sunset to sunrise
2	On Pilot Request
1	On Pilot Request
*During a 1 year period, twilight may vary 26 to 43 minutes between 25 and 49N latitude.	

3-4-5. APPROACH LIGHTS

Operate approach lights:

a. Between sunset and sunrise when one of the following conditions exists:

1. They serve the landing runway.
2. They serve a runway to which an approach is being made but aircraft will land on another runway.

b. Between sunrise and sunset when the ceiling is less than 1,000 feet or the prevailing visibility is 5 miles or less and approaches are being made to:

1. A landing runway served by the lights.
2. A runway served by the lights but aircraft are landing on another runway.
3. The airport, but landing will be made on a runway served by the lights.

c. As requested by the pilot.

d. As you deem necessary, if not contrary to pilot's request.

NOTE-
In the interest of energy conservation, the ALS should be turned off when not needed for aircraft operations.

REFERENCE-
FAAO 7110.65, *ALS Intensity Settings, Para 3-4-6*

3-4-6. ALS INTENSITY SETTINGS

When operating ALS as prescribed in para 3-4-5, Approach Lights, operate intensity controls in accordance with the values in TBL 3-4-5 except:

- a. When facility directives specify other settings to meet local atmospheric, topographic, and twilight conditions.
- b. As requested by the pilot.
- c. As you deem necessary, if not contrary to pilot's request.

TBL 3-4-5

ALS Intensity Setting

Step	Visibility (Applicable to runway served by lights)	
	Day	Night
5	Less than 1 mile*	When requested
4	1 to but not including 3 miles	When requested
3	3 to but not including 5 miles	Less than 1 mile*
2	5 to but not including 7 miles	1 to 3 miles inclusive
1	When requested	Greater than 3 miles
*and/or 6,000 feet or less of the RVR on the runway served by the ALS and RVR.		

NOTE-
Daylight steps 2 and 3 provide recommended settings applicable to conditions in subparas b and c. At night, use step 4 or 5 only when requested by a pilot.

3-4-7. SEQUENCED FLASHING LIGHTS (SFL)

Operate Sequenced Flashing Lights:

NOTE-
SFL are a component of the ALS and cannot be operated when the ALS is off.

a. When the visibility is less than 3 miles and instrument approaches are being made to the runway served by the associated ALS.

- b. As requested by the pilot.
- c. As you deem necessary, if not contrary to pilot's request.

3-4-8. MALSR/ODALS

Operate MALSR/ODALS that have separate on-off and intensity setting controls in accordance with TBL 3-4-6 and TBL 3-4-7 except:

a. When facility directives specify other settings to meet local atmospheric, topographic, and twilight conditions.

- b. As requested by the pilot.
- c. As you deem necessary, if not contrary to pilot's request.

TBL 3-4-6

Two Step MALS/One Step RAIL/Two Step ODALS

Settings		Visibility	
		Day	Night
MALS/ODALS RAIL	Hi On	Less than 3 miles	Less than 3 miles
MALS/ODALS RAIL	Low Off	When requested	3 miles or more
*At locations providing part-time control tower service, if duplicate controls are not provided in the associated FSS, the MALS/ODALS shall be set to low intensity during the hours of darkness when the tower is not staffed.			

TBL 3-4-7

**Three Step MALS/Three Step RAIL/
Three Step ODALS**

Settings	Visibility	
	Day	Night
3	Less than 2 miles	Less than 1 mile
2	2 to 5 miles inclusive	1 to but not including 3 miles*
1	When requested	3 miles or more
*At locations providing part-time control tower service, if duplicate controls are not provided in the FSS on the airport, the air-to-ground radio link shall be activated during the hours of darkness when the tower is unmanned. If there is no radio air-to-ground control, the MALS/ODALS shall be set on intensity setting 2 during the hours of darkness when the tower is not staffed.		

REFERENCE-
FAAO 7210.3, Operation of Lights When Tower is Closed, Para 10-6-2.

3-4-9. ALSF-2/SSALR

- a. When the prevailing visibility is ³/₄ mile or less or the RVR is 4,000 feet or less, operate the ALSF-2 system as follows:
 - 1. As requested by the pilot.
 - 2. As you deem necessary if not contrary to pilot request.
- b. Operate the SSALR system when the conditions in subpara a are not a factor.

3-4-10. RUNWAY EDGE LIGHTS

Operate the runway edge light system/s serving the runway/s in use as follows:

- a. Between sunset and sunrise, turn the lights on:
 - 1. For departures. Before an aircraft taxis onto the runway and until it leaves the Class B, Class C, or Class D surface area.
 - 2. For arrivals:
 - (a) IFR aircraft—Before the aircraft begins final approach, or
 - (b) VFR aircraft—Before the aircraft enters the Class B, Class C, or Class D surface area, and
 - (c) Until the aircraft has taxied off the landing runway.
- b. Between sunrise and sunset, turn the lights on as shown in subparas a1 and a2 when the surface visibility is less than 2 miles.

c. As required by facility directives to meet local conditions.

d. Different from subparas a, b, or c above, when:

- 1. You consider it necessary, or
- 2. Requested by a pilot and no other known aircraft will be adversely affected.

NOTE-
Pilots may request lights to be turned on or off contrary to subparas a, b, or c. However, 14 CFR Part 135 operators are required to land/takeoff on lighted runways/heliport landing areas at night.

e. Do not turn on the runway edge lights when a NOTAM closing the runway is in effect.

NOTE-
Application concerns use for takeoffs/landings/approaches and does not preclude turning lights on for use of unaffected portions of a runway for taxiing aircraft, surface vehicles, maintenance, repair, etc.

REFERENCE-
FAAO 7110.65, Simultaneous Approach and Runway Edge Light Operation, Para 3-4-15
FAAO 7210.3, Incompatible Light System Operation, Para 10-6-3.
FAAO 7210.3, Runway Edge Lights Associated With Medium Approach Light System/Runway Alignment Indicator Lights, Para 10-6-9.

3-4-11. HIGH INTENSITY RUNWAY, RUNWAY CENTERLINE, AND TOUCHDOWN ZONE LIGHTS

Operate high intensity runway and associated runway centerline and touchdown zone lights in accordance with TBL 3-4-8, except:

- a. Where a facility directive specifies other settings to meet local conditions.
- b. As requested by the pilot.
- c. As you deem necessary, if not contrary to pilot request.

TBL 3-4-8
HIRL, RCLS, TDZL Intensity Setting

Step	Visibility	
	Day	Night
5	Less than 1 mile*	When requested
4	1 to but not including 2 miles*	Less than 1 mile*
3	2 to but not including 3 miles	1 to but not including 3 miles*
2	When requested	3 to 5 miles inclusive
1	When requested	More than 5 miles

*and/or appropriate RVR/RVV equivalent.

3-4-12. HIRL ASSOCIATED WITH MALSR

Operate HIRL which control the associated MALSR in accordance with TBL 3-4-9, except:

- a. As requested by the pilot.
- b. As you deem necessary, if not contrary to the pilot's request.

TBL 3-4-9
HIRL Associated with MALSR

Step	Visibility	
	Day	Night
5	Less than 1 mile	When requested
4	1 to but not including 2 miles	Less than 1 mile
3	2 to but not including 3 miles	1 to but not including 3 miles
2	When requested	3 to 5 miles inclusive
1	When requested	More than 5 miles

NOTE-
When going from a given brightness step setting to a lower setting, rotation of the brightness control to a point below

the intended step setting and then back to the appropriate step setting will ensure that the MALSR will operate at the appropriate brightness.

REFERENCE-
FAAO 7110.65, *Medium Intensity Runway Lights, Para 3-4-14*

3-4-13. HIRL CHANGES AFFECTING RVR

Keep the appropriate approach controller or PAR controller informed, in advance if possible, of HIRL changes that affect RVR.

3-4-14. MEDIUM INTENSITY RUNWAY LIGHTS

Operate MIRL or MIRL which control the associated MALSR in accordance with TBL 3-4-10, except:

- a. As requested by the pilot.
- b. As you deem necessary, if not contrary to the pilot's request.

TBL 3-4-10
MIRL Intensity Setting

Step	Visibility	
	Day	Night
3	Less than 2 miles	Less than 1 mile
2	2 to 3 miles	1 to 3 miles
1	When requested	More than 3 miles

REFERENCE-
FAAO 7110.65, *HIRL Associated With MALSR, Para 3-4-12*

3-4-15. SIMULTANEOUS APPROACH AND RUNWAY EDGE LIGHT OPERATION

Turn on the runway edge lights for the runway in use whenever the associated approach lights are on. If multiple runway light selection is not possible, you may leave the approach lights on and switch the runway lights to another runway to accommodate another aircraft.

REFERENCE-
FAAO 7110.65, *Runway Edge Lights, Para 3-4-10*

3-4-16. HIGH SPEED TURNOFF LIGHTS

Operate high speed turnoff lights:

- a. Whenever the associated runway lights are used for arriving aircraft. Leave them on until the aircraft has either entered a taxiway or passed the last light.
- b. As required by facility directives to meet local conditions.
- c. As requested by the pilot.

3-4-17. TAXIWAY LIGHTS

Operate taxiway lights in accordance with TBL 3-4-11, TBL 3-4-12, or TBL 3-4-13 except:

- a. Where a facility directive specifies other settings or times to meet local conditions.
- b. As requested by the pilot.
- c. As you deem necessary, if not contrary to pilot request.

TBL 3-4-11

Three Step Taxiway Lights

Step	Visibility	
	Day	Night
3	Less than 1 mile	When requested
2	When requested	Less than 1 mile
1	When requested	1 mile or more

TBL 3-4-12

Five Step Taxiway Lights

Step	Visibility	
	Day	Night
5	Less than 1 mile	When requested
4	When requested	Less than 1 mile
3	When requested	1 mile or more
1 & 2	When requested	When requested

TBL 3-4-13

One Step Taxiway Lights

Day	Night
Less than 1 mile	On

NOTE-

AC 150/5340-24, Runway and Taxiway Edge Lighting System, contains recommended brightness levels for variable setting taxiway lights.

3-4-18. OBSTRUCTION LIGHTS

If controls are provided, turn the lights on between sunset and sunrise.

3-4-19. ROTATING BEACON

If controls are provided, turn the rotating beacon on:

- a. Between sunset and sunrise.
- b. Between sunrise and sunset when the reported ceiling or visibility is below basic VFR minima.

Section 5. Runway Selection

3-5-1. SELECTION

a. Except where a “runway use” program is in effect, use the runway most nearly aligned with the wind when 5 knots or more or the “calm wind” runway when less than 5 knots (set tetrahedron accordingly) unless use of another runway:

NOTE-

1. *If a pilot prefers to use a runway different from that specified, the pilot is expected to advise ATC.*

2. *At airports where a “runway use” program is established, ATC will assign runways deemed to have the least noise impact. If in the interest of safety a runway different from that specified is preferred, the pilot is expected to advise ATC accordingly. ATC will honor such requests and advise pilots when the requested runway is noise sensitive.*

REFERENCE-

FAAO 8400.9, *National Safety and Operational Criteria for Runway Use Programs.*

1. Will be operationally advantageous, or
2. Is requested by the pilot.

b. When conducting aircraft operations on other than the advertised active runway, state the runway in use.

3-5-2. STOL RUNWAYS

Use STOL runways as follows:

a. A designated STOL runway may be assigned only when requested by the pilot or as specified in a letter of agreement with an aircraft operator.

b. Issue the measured STOL runway length if the pilot requests it.

3-5-3. TAILWIND COMPONENTS

When authorizing use of runways and a tailwind component exists, always state both wind direction and velocity.

NOTE-

The wind may be described as “calm” when appropriate.

REFERENCE-

FAAO 7110.65, *Calm Wind Conditions, Para 2-6-5*

Section 6. Airport Surface Detection Procedures

3-6-1. EQUIPMENT USAGE

a. ASDE/AMASS shall be operated continuously to augment visual observation of aircraft landing or departing, and aircraft or vehicular movements on runways and taxiways, or other areas of the movement area.

b. The operational status of ASDE/AMASS/ASDE-X shall be determined during the relief briefing, or as soon as possible after assuming responsibility for the associated control position.

c. Use ASDE-X to augment visual observation of aircraft and/or vehicular movements on runways and taxiways, or other areas of the movement area:

1. When visibility is less than the most distant point in the active movement area, and

2. When, in your judgement, its use will assist you in the performance of your duties at any time.

3. ASDE-X shall be operated continuously between sunset and sunrise regardless of the visibility.

3-6-2. INFORMATION USAGE

a. ASDE/AMASS/ASDE-X derived information may be used to:

1. Formulate clearances and control instructions to aircraft.

2. Formulate control instructions to vehicles on the movement area.

REFERENCE-

FAAO 7210.3, Radar Use, Para 3-7-2b2.

3. Position aircraft and vehicles using the movement area.

4. Determine the exact location of aircraft and vehicles, or spatial relationship to other aircraft/vehicles on the movement area.

5. Monitor compliance with control instructions by aircraft and vehicles on taxiways and runways.

6. Confirm pilot reported positions.

7. Provide directional taxi information, as appropriate.

PHRASEOLOGY-

TURN (left/right) ON THE TAXIWAY/RUNWAY YOU ARE APPROACHING.

b. Do not provide specific navigational guidance (exact headings to be followed) unless an emergency exists or by mutual agreement with the pilot.

NOTE-

It remains the pilot's responsibility to navigate visually via routes to the clearance limit specified by the controller and to avoid other parked or taxiing aircraft, vehicles, or persons in the movement area.

3-6-3. IDENTIFICATION

To identify an observed target on the ASDE/AMASS/ASDE-X display, correlate its position with one or more of the following:

a. Pilot position report.

b. Controller's visual observation.

c. An identified target observed on the ASR or BRITE/DBRITE/TDW display.

3-6-4. AMASS ALERT RESPONSES

When the system alarms, the controller shall immediately assess the situation visually and as presented on the ASDE/AMASS display, then take appropriate action, as follows:

a. When an arrival aircraft (still airborne, prior to the landing threshold) activates an alarm, the controller shall issue go-around instructions. (Exception: Alarms involving known formation flights, as they cross the landing threshold, may be disregarded if all other factors are acceptable.)

b. For other AMASS alarms, issue instructions/clearances based on good judgment and evaluation of the situation at hand.

Section 7. Taxi and Ground Movement Procedures

3-7-1. GROUND TRAFFIC MOVEMENT

Issue by radio or directional light signals specific instructions which approve or disapprove the movement of aircraft, vehicles, equipment, or personnel on the movement area.

a. Do not issue *conditional* instructions that are dependent upon the movement of an arrival aircraft on or approaching the runway or a departure aircraft established on a takeoff roll. Do not say, "Position and hold behind landing traffic," or "Taxi/proceed across Runway Three Six behind departing/landing Jetstar." The above requirements do not preclude issuing instructions to follow an aircraft observed to be operating on the movement area in accordance with an ATC clearance/instruction and in such a manner that the instructions to follow are not ambiguous.

b. Do not use the word "cleared" in conjunction with authorization for aircraft to taxi or equipment/vehicle/personnel operations. Use the prefix "taxi," "proceed," or "hold," as appropriate, for aircraft instructions and "proceed" or "hold" for equipment/vehicles/personnel.

c. Intersection departures may be initiated by a controller or a controller may authorize an intersection departure if a pilot requests. Issue the measured distance from the intersection to the runway end rounded "down" to the nearest 50 feet to any pilot who requests and to all military aircraft, unless use of the intersection is covered in appropriate directives.

NOTE-

Exceptions are authorized where specific military aircraft routinely make intersection takeoffs and procedures are defined in appropriate directives. The authority exercising operational control of such aircraft ensures that all pilots are thoroughly familiar with these procedures, including the usable runway length from the applicable intersection.

d. State the runway intersection when authorizing an aircraft to taxi into position to hold or when clearing an aircraft for takeoff from an intersection.

PHRASEOLOGY-

RUNWAY (number) AT (taxiway designator) (further instructions as needed).

RUNWAY (number) AT (taxiway designator), POSITION AND HOLD.

If requested or required,

*RUNWAY (number) AT (taxiway designator)
INTERSECTION DEPARTURE, (remaining length)
FEET AVAILABLE.*

e. If two or more aircraft call the tower ready for departure, one or more at the approach and one or more at the intersection, state the location of the aircraft at the full length of the runway when authorizing that aircraft to taxi into position and hold or when clearing that aircraft for takeoff.

PHRASEOLOGY-

RUNWAY (number), FULL-LENGTH, POSITION AND HOLD.

or

RUNWAY (number) FULL LENGTH, CLEARED FOR TAKEOFF.

EXAMPLE-

"American Four Eighty Two, Runway Three Zero full length, position and hold."

"Cherokee Five Sierra Whiskey, Runway Two Five Right full length, cleared for takeoff."

NOTE-

The controller need not state the location of the aircraft departing the full length of the runway if there are no aircraft holding for departure at an intersection for that same runway.

REFERENCE-

FAAO 7110.65, Taxi into Position and Hold (TIPH), Para 3-9-4.

3-7-2. TAXI AND GROUND MOVEMENT OPERATIONS

Issue, as required or requested, the route for the aircraft/vehicle to follow on the movement area in concise and easy to understand terms. When a taxi clearance to a runway is issued to an aircraft, confirm the aircraft has the correct runway assignment.

NOTE-

1. *A pilot's read back of taxi instructions with the runway assignment can be considered confirmation of runway assignment.*

2. *Movement of aircraft or vehicles on nonmovement areas is the responsibility of the pilot, the aircraft operator, or the airport management.*

a. When authorizing a vehicle to proceed on the movement area, or an aircraft to taxi to any point other than an assigned takeoff runway, absence of holding instructions authorizes an aircraft/vehicle to cross all taxiways and runways that intersect the taxi route. If it is the intent to hold the aircraft/vehicle short of any given point along the taxi route, issue the route, if necessary, then state the holding instructions.

NOTE-

Movement of aircraft or vehicles on nonmovement areas is the responsibility of the pilot, the aircraft operator, or the airport management.

PHRASEOLOGY-
HOLD POSITION.

HOLD FOR (reason)

CROSS (runway/taxiway)

or

TAXI/CONTINUE TAXIING/PROCEED/VIA (route),

or

ON (runway number or taxiways, etc.),

or

TO (location),

or

(direction),

or

ACROSS RUNWAY (number).

or

VIA (route), HOLD SHORT OF (location)

or

FOLLOW (traffic) (restrictions as necessary)

or

BEHIND (traffic).

EXAMPLE-

“Cross Runway Two Eight Left.”

“Taxi/continue taxiing/proceed to the hangar.”

“Taxi/continue taxiing/proceed straight ahead then via ramp to the hangar.”

“Taxi/continue taxiing/proceed on Taxiway Charlie, hold short of Runway Two Seven.”

or

“Taxi/continue taxiing/proceed on Charlie, hold short of Runway Two Seven.”

b. When authorizing an aircraft to taxi to an assigned takeoff runway and hold short instructions are not issued, specify the runway preceded by “taxi to,” and issue taxi instructions if necessary. This authorizes the aircraft to “cross” all runways/taxiways which the taxi route intersects except the assigned takeoff runway. This does not authorize the aircraft to “enter” or “cross” the assigned takeoff runway at any point.

PHRASEOLOGY-

TAXI TO RUNWAY (number) VIA . . .

EXAMPLE-

“Taxi to Runway One Two.”

“Taxi to Runway Three Six via Taxiway Echo.”

or

“Taxi to Runway Three Six via Echo.”

c. Specify the runway for departure, any necessary taxi instructions, and hold short restrictions when an aircraft will be required to hold short of a runway or other points along the taxi route.

EXAMPLE-

“Runway Three Six Left, taxi via taxiway Alpha, hold short of taxiway Charlie.”

or

“Runway Three Six Left, taxi via Alpha, hold short of Charlie.”

PHRASEOLOGY-

RUNWAY (number),

TAXI/PROCEED VIA (route if necessary),

HOLD SHORT OF (runway number)

or

HOLD SHORT OF (location)

or

ON (taxi strip, runup, pad, etc.),

and if necessary,

TRAFFIC (traffic information),

or

FOR (reason).

EXAMPLE–

“Runway Three Six Left, taxi via taxiway Charlie, hold short of Runway Two Seven Right.”

or

“Runway Three Six Left, taxi via Charlie, hold short of Runway Two Seven Right.”

“Runway Three Six Left, hold short of Runway Two Seven Right.”

d. Request a read back of runway hold short instructions when it is not received from the pilot/vehicle operator.

**PHRASEOLOGY–
READ BACK HOLD INSTRUCTIONS.**

EXAMPLE–

1. “American Four Ninety Two, Runway Three Six Left, taxi via taxiway Charlie, hold short of Runway Two Seven Right.”

or

“American Four Ninety Two, Runway Three Six Left, taxi via Charlie, hold short of Runway Two Seven Right.”

“American Four Ninety Two, Roger.”

“American Four Ninety Two, read back hold instructions.”

2. “Cleveland Tower, American Sixty Three is ready for departure.”

“American Sixty Three, hold short of Runway Two Three Left, traffic one mile final.”

“American Sixty Three, Roger.”

“American Sixty Three, read back hold instructions.”

3. “OPS Three proceed via taxiway Charlie hold short of Runway Two Seven.”

or

“OPS Three proceed via Charlie hold short of Runway Two Seven.”

“OPS Three, Roger.”

“OPS Three, read back hold instructions.”

NOTE–

Read back hold instructions phraseology may be initiated for any point on a movement area when the controller believes the read back is necessary.

e. Issue progressive taxi/ground movement instructions when:

1. Pilot/operator requests.

2. The specialist deems it necessary due to traffic or field conditions, e.g., construction or closed taxiways.

3. As necessary during reduced visibility, especially when the taxi route is not visible from the tower.

f. Progressive ground movement instructions include step-by-step routing directions.

REFERENCE–

FAAO 7110.65, Runway Proximity, Para 3–7–4

FAAO 7110.65, Taxi and Ground Movement Operation, Para 3–II–1.

g. Instructions to expedite a taxiing aircraft or a moving vehicle.

PHRASEOLOGY–

TAXI WITHOUT DELAY (traffic if necessary).

EXIT/PROCEED/CROSS

(runway/taxiway) WITHOUT DELAY.

3–7–3. GROUND OPERATIONS

WAKE TURBULENCE APPLICATION

Avoid clearances which require:

a. Heavy jet aircraft to use greater than normal taxiing power.

b. Small aircraft or helicopters to taxi in close proximity to taxiing or hover-taxi helicopters.

NOTE–

Use caution when taxiing smaller aircraft/helicopters in the vicinity of larger aircraft.

REFERENCE–

AC 90–23, Aircraft Wake Turbulence, Para 10 and Para 11.

3-7-4. RUNWAY PROXIMITY

Hold a taxiing aircraft or vehicle clear of the runway as follows:

- a. Instruct aircraft or vehicle to hold short of a specific runway.
- b. Instruct aircraft or vehicle to hold at a specified point.
- c. Issue traffic information as necessary.

PHRASEOLOGY-

HOLD SHORT OF/AT (runway number or specific point), (traffic or other information).

NOTE-

Establishing hold lines/signs is the responsibility of the airport manager. The standards for surface measurements, markings, and signs are contained in AC 150/5300-13, Airport Design; AC 150/5340-1, Standards for Airport Markings, and AC 150/5340-18, Standards for Airport Sign Systems. The operator is responsible for properly positioning the aircraft, vehicle, or equipment at the appropriate hold line/sign or designated point. The requirements in para 3-1-12 Visually Scanning Runways, remain valid as appropriate.

REFERENCE-

*FAAO 7110.65, Taxi and Ground Movement Operations, Para 3-7-2
FAAO 7110.65, Altitude Restricted Low Approach, Para 3-10-10
FAAO 7110.65, Vehicles/Equipment/Personnel on Runways, Para 3-1-5*

3-7-5. PRECISION APPROACH CRITICAL AREA

a. ILS critical area dimensions are described in FAAO 6750.16, Siting Criteria for Instrument Landing Systems. Aircraft and vehicle access to the ILS/MLS critical area must be controlled to ensure the integrity of ILS/MLS course signals whenever conditions are less than reported ceiling 800 feet or visibility less than 2 miles. Do not authorize vehicles/aircraft to operate in or over the critical area, except as specified in subpara a1, whenever an arriving aircraft is inside the ILS outer marker (OM) or the fix used in lieu of the OM unless the arriving aircraft has reported the runway in sight or is circling to land on another runway.

PHRASEOLOGY-

HOLD SHORT OF (runway) ILS/MLS CRITICAL AREA.

1. LOCALIZER CRITICAL AREA

(a) Do not authorize vehicle or aircraft operations in or over the area when an arriving aircraft is inside the ILS OM or the fix used in lieu of the OM when conditions are less than reported ceiling 800 feet or visibility less than 2 miles, except:

(1) A preceding arriving aircraft on the same or another runway that passes over or through the area while landing or exiting the runway.

(2) A preceding departing aircraft or missed approach on the same or another runway that passes through or over the area.

(b) In addition to subpara a1(a), do not authorize vehicles or aircraft operations in or over the area when an arriving aircraft is inside the middle marker when conditions are less than reported ceiling 200 feet or RVR 2,000 feet.

2. GLIDESLOPE CRITICAL AREA. Do not authorize vehicles or aircraft operations in or over the area when an arriving aircraft is inside the ILS OM or the fix used in lieu of the OM unless the arriving aircraft has reported the runway in sight or is circling to land on another runway when conditions are less than reported ceiling 800 feet or visibility less than 2 miles.

b. Air carriers commonly conduct “coupled” or “autoland” operations to satisfy maintenance, training, or reliability program requirements. Promptly issue an advisory if the critical area will not be protected when an arriving aircraft advises that a “coupled,” “CATIII,” “autoland,” or similar type approach will be conducted and the weather is reported ceiling of 800 feet or more, and the visibility is 2 miles or more.

PHRASEOLOGY-

ILS/MLS CRITICAL AREA NOT PROTECTED.

c. The Department of Defense (DOD) is authorized to define criteria for protection of precision approach critical areas at military controlled airports. This protection is provided to all aircraft operating at that military controlled airport. Waiver authority for DOD precision approach critical area criteria rests with the appropriate military authority.

NOTE-

Signs and markings are installed by the airport operator to define the ILS/MLS critical area. No point along the longitudinal axis of the aircraft is permitted past the hold line for holding purposes. The operator is responsible to properly position the aircraft, vehicle, or equipment at the appropriate hold line/sign or designated point. The requirements in para 3-1-12 Visually Scanning Runways, remain valid as appropriate.

REFERENCE-

AC150/5340-1, Standards for Airport Markings.

Section 8. Spacing and Sequencing

3-8-1. SEQUENCE/SPACING APPLICATION

Establish the sequence of arriving and departing aircraft by requiring them to adjust flight or ground operation, as necessary, to achieve proper spacing.

PHRASEOLOGY—
CLEARED FOR TAKEOFF.

CLEARED FOR TAKEOFF OR HOLD SHORT/HOLD IN POSITION/TAXI OFF THE RUNWAY (traffic).

EXTEND DOWNWIND.

MAKE SHORT APPROACH.

NUMBER (landing sequence number),

FOLLOW (description and location of traffic),

or if traffic is utilizing another runway,

TRAFFIC (description and location) LANDING RUNWAY (number of runway being used).

CIRCLE THE AIRPORT.

MAKE LEFT/RIGHT THREE-SIXTY/TWO SEVENTY.

■ *GO AROUND (additional instructions as necessary).*

CLEARED TO LAND.

CLEARED:

TOUCH-AND-GO,
or

STOP-AND-GO,
or

LOW APPROACH.

CLEARED FOR THE OPTION,

or

OPTION APPROVED,

or

UNABLE OPTION, (alternate instructions).

or

UNABLE (type of option), OTHER OPTIONS APPROVED.

NOTE—

1. The “Cleared for the Option” procedure will permit an instructor pilot/flight examiner/pilot the option to make a touch-and-go, low approach, missed approach, stop-and-go, or full stop landing. This procedure will only be used at those locations with an operational control tower and will be subject to ATC approval.

2. For proper helicopter spacing, speed adjustments may be more practical than course changes.

3. Read back of hold short instructions apply when hold instructions are issued to a pilot in lieu of a takeoff clearance.

REFERENCE—

FAAO 7110.65, Taxi and Ground Movement Operations, Para 3-7-2

3-8-2. TOUCH-AND-GO OR STOP-AND-GO OR LOW APPROACH

Consider an aircraft cleared for touch-and-go, stop-and-go, or low approach as an arriving aircraft until it touches down (for touch-and-go), or makes a complete stop (for stop-and-go), or crosses the landing threshold (for low approach), and thereafter as a departing aircraft.

REFERENCE—

FAAO 7110.65, Vehicles/Equipment/Personnel on Runways, Para 3-1-5
FAAO 7110.65, Wake Turbulence Separation for Intersection Departures, Para 3-9-7

3-8-3. SIMULTANEOUS SAME DIRECTION OPERATION

Authorize simultaneous, same direction operations on parallel runways, on parallel landing strips, or on a runway and a parallel landing strip only when the following conditions are met:

a. Operations are conducted in VFR conditions unless visual separation is applied.

b. Two-way radio communication is maintained with the aircraft involved and pertinent traffic information is issued.

c. The distance between the runways or landing strips is in accordance with the minima in TBL 3-8-1 (use the greater minimum if two categories are involved).

**TBL 3-8-1
Same Direction Distance Minima**

Aircraft category	Minimum distance (feet) between parallel	
	Runway centerlines	Edges of adjacent strips or runway and strip
Lightweight, single-engine, propeller driven	300	200
Twin-engine, propeller driven	500	400
All others	700	600

3-8-4. SIMULTANEOUS OPPOSITE DIRECTION OPERATION

Authorize simultaneous opposite direction operations on parallel runways, on parallel landing strips, or on a runway and a parallel landing strip only when the following conditions are met:

a. Operations are conducted in VFR conditions.

b. Two-way radio communication is maintained with the aircraft involved and pertinent traffic information is issued.

PHRASEOLOGY-
TRAFFIC (description) ARRIVING/DEPARTING/LOW APPROACH, OPPOSITE DIRECTION ON PARALLEL RUNWAY/LANDING STRIP.

c. The distance between the runways or landing strips is in accordance with the minima in TBL 3-8-2.

**TBL 3-8-2
Opposite Direction Distance Minima**

Type of Operation	Minimum distance (feet) between parallel	
	Runway centerlines	Edges of adjacent strips or runway and strip
Between sunrise and sunset	1,400	1,400
Between sunset and sunrise	2,800	Not authorized

Section 9. Departure Procedures and Separation

3-9-1. DEPARTURE INFORMATION

Provide current departure information, as appropriate, to departing aircraft.

a. Departure information contained in the ATIS broadcast may be omitted if the pilot states the appropriate ATIS code.

b. Issue departure information by including the following:

1. Runway in use. (May be omitted if pilot states “have the numbers.”)

2. Surface wind from direct readout dial, windshear detection system, or automated weather observing system information display. (May be omitted if pilot states “have the numbers.”)

3. Altimeter setting. (May be omitted if pilot states “have the numbers.”)

REFERENCE-

FAAO 7110.65, *Current Settings, Para 2-7-1*

c. Time, when requested.

d. Issue the official ceiling and visibility, when available, to a departing aircraft before takeoff as follows:

1. To a VFR aircraft when weather is below VFR conditions.

2. To an IFR aircraft when weather is below VFR conditions or highest takeoff minima, whichever is greater.

NOTE-

Standard takeoff minimums are published in 14 CFR Section 91.175(f). Takeoff minima other than standard are prescribed for specific airports/runways and published in a tabular form supplement to the FAA instrument approach procedures charts and appropriate FAA Forms 8260.

e. Taxi information, as necessary. You need not issue taxi route information unless the pilot specifically requests it.

f. **USAF NOT APPLICABLE.** An advisory to “check density altitude” when appropriate.

REFERENCE-

FAAO 7210.3, *Broadcast Density Altitude Advisory, Para 2-10-6.*

g. Issue braking action for the runway in use as received from pilots or the airport management when Braking Action Advisories are in effect.

REFERENCE-

FAAO 7110.65, *Altimeter Setting Issuance Below Lowest Usable FL, Para 2-7-2*

FAAO 7110.65, *Low Level Wind Shear/Microburst Advisories, Para 3-1-8*

FAAO 7110.65, *Braking Action Advisories, Para 3-3-5*
P/CG Term- *Braking Action Advisories.*

3-9-2. DEPARTURE DELAY INFORMATION

USA/USAF/USN NOT APPLICABLE

When gate-hold procedures are in effect, issue the following departure delay information as appropriate:

REFERENCE-

FAAO 7210.3, *Gate Hold Procedures, Para 10-4-3.*

a. Advise departing aircraft the time at which the pilot can expect to receive engine startup advisory.

PHRASEOLOGY-

GATE HOLD PROCEDURES ARE IN EFFECT. ALL AIRCRAFT CONTACT (position) ON (frequency) FOR ENGINE START TIME. EXPECT ENGINE START/TAXI (time).

b. Advise departing aircraft when to start engines and/or to advise when ready to taxi.

PHRASEOLOGY-

START ENGINES, ADVISE WHEN READY TO TAXI,

or

ADVISE WHEN READY TO TAXI.

c. If the pilot requests to hold in a delay absorbing area, the request shall be approved if space and traffic conditions permit.

d. Advise all aircraft on GC/FD frequency upon termination of gate hold procedures.

PHRASEOLOGY-

GATE HOLD PROCEDURES NO LONGER IN EFFECT.

3-9-3. DEPARTURE CONTROL INSTRUCTIONS

Inform departing IFR, SVFR, VFR aircraft receiving radar service, and TRSA VFR aircraft of the following:

a. Before takeoff.

1. Issue the appropriate departure control frequency and beacon code. The departure control frequency may be omitted if a DP has been or will be assigned and the departure control frequency is published on the DP.

PHRASEOLOGY-

DEPARTURE FREQUENCY (frequency), SQUAWK (code).

2. Inform all departing IFR military turboprop/turbojet aircraft (except transport and cargo types) to change to departure control frequency. If the local controller has departure frequency override, transmit urgent instructions on this frequency. If the override capability does not exist, transmit urgent instructions on the emergency frequency.

PHRASEOLOGY-

CHANGE TO DEPARTURE.

3. **USAF.** USAF control towers are authorized to inform all departing IFR military transport/cargo type aircraft operating in formation flight to change to departure control frequency before takeoff.

b. After takeoff.

1. When the aircraft is about $\frac{1}{2}$ mile beyond the runway end, instruct civil aircraft, and military transport, and cargo types to contact departure control, provided further communication with you is not required.

2. Do not request departing military turboprop/turbojet aircraft (except transport and cargo types) to make radio frequency or radar beacon changes before the aircraft reaches 2,500 feet above the surface.

REFERENCE-

FAAO 7110.65, Visual Separation, Para 7-2-1

3-9-4. TAXI INTO POSITION AND HOLD (TIPH)

a. The intent of TIPH is to position aircraft for an imminent departure. Authorize an aircraft to taxi into position and hold, except as restricted in subpara f, when takeoff clearance cannot be issued because of traffic. Issue traffic information to any aircraft so authorized. Traffic information may be omitted when the traffic is another aircraft which has landed on or is taking off the same runway and is clearly visible to the holding aircraft. Do not use conditional phrases such as “behind landing traffic” or “after the departing aircraft.”

b. **USN NOT APPLICABLE.** First state the runway number followed by the taxi into position clearance when more than one runway is active.

PHRASEOLOGY-

RUNWAY (number), POSITION AND HOLD.

Or, when only one runway is active:

POSITION AND HOLD.

c. When an aircraft is authorized to taxi into takeoff position to hold, inform it of the closest traffic that is cleared to land, touch-and-go, stop-and-go, or unrestricted low approach on the same runway.

EXAMPLE-

“United Five, runway one eight, position and hold. Traffic a Boeing Seven Thirty Seven, six mile final.”

Or, when only one runway is active:

“United Five, position and hold. Traffic a Boeing Seven Thirty Seven, six mile final.”

d. **USAF.** When an aircraft is authorized to taxi into takeoff position to hold, inform it of the closest traffic within 6 miles on final approach to the same runway. If the approaching aircraft is on a different frequency, inform it of the aircraft taxiing into position.

e. Do not authorize an aircraft to taxi into position and hold when the departure point is not visible from the tower, unless the aircraft’s position can be verified by ASDE or the runway is used for departures only.

f. Do not authorize an aircraft to taxi into position and hold at an intersection between sunset and sunrise or at anytime when the intersection is not visible from the tower.

g. **USN.** Do not authorize aircraft to taxi into takeoff position to hold simultaneously on intersecting runways.

PHRASEOLOGY-

CONTINUE HOLDING,

or

TAXI OFF THE RUNWAY.

REFERENCE-

FAAO 7110.65, Altitude Restricted Low Approach, Para 3-10-10

h. When a local controller delivers or amends an ATC clearance to an aircraft awaiting departure and that aircraft is holding short of a runway or is holding in position on a runway, an additional clearance shall

be issued to prevent the possibility of the aircraft inadvertently taxiing onto the runway and/or beginning takeoff roll. In such cases, append one of the following ATC instructions as appropriate:

1. HOLD SHORT OF RUNWAY, *or*
2. HOLD IN POSITION.

i. *USAF/USN.* When issuing additional instructions or information to an aircraft holding in takeoff position, include instructions to continue holding or taxi off the runway, unless it is cleared for takeoff.

PHRASEOLOGY-
CONTINUE HOLDING,

or

TAXI OFF THE RUNWAY.

REFERENCE-
FAAO 7110.65, Altitude Restricted Low Approach, Para 3-10-10

3-9-5. ANTICIPATING SEPARATION

Takeoff clearance needs not be withheld until prescribed separation exists if there is a reasonable assurance it will exist when the aircraft starts takeoff roll.

3-9-6. SAME RUNWAY SEPARATION

Separate a departing aircraft from a preceding departing or arriving aircraft using the same runway by ensuring that it does not begin takeoff roll until:

a. The other aircraft has departed and crossed the runway end or turned to avert any conflict. (See FIG 3-9-1.) If you can determine distances by reference to suitable landmarks, the other aircraft needs only be airborne if the following minimum distance exists between aircraft: (See FIG 3-9-2.)

1. When only Category I aircraft are involved- *3,000 feet.*
2. When a Category I aircraft is preceded by a Category II aircraft- *3,000 feet.*
3. When either the succeeding or both are Category II aircraft- *4,500 feet.*

4. When either is a Category III aircraft- *6,000 feet.*

5. When the succeeding aircraft is a helicopter, visual separation may be applied in lieu of using distance minima.

FIG 3-9-1

Same Runway Separation
[View 1]

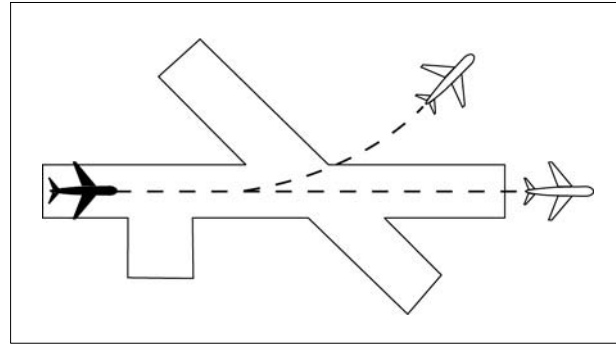
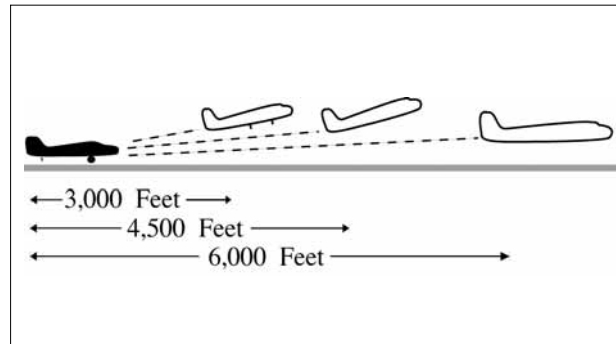

FIG 3-9-2

Same Runway Separation
[View 2]



NOTE-

Aircraft same runway separation (SRS) categories are specified in Appendices A, B, and C and based upon the following definitions:

CATEGORY I- small aircraft weighing 12,500 lbs. or less, with a single propeller driven engine, and all helicopters.

CATEGORY II- small aircraft weighing 12,500 lbs. or less, with propeller driven twin-engines.

CATEGORY III- all other aircraft.

b. A preceding landing aircraft is clear of the runway. (See FIG 3-9-3.)

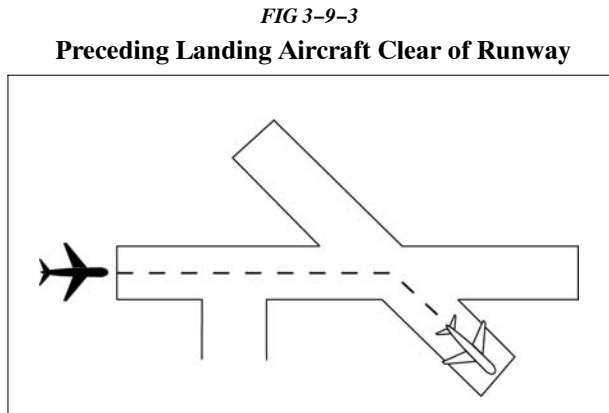

REFERENCE-
P/CG Term- Clear of the Runway.

WAKE TURBULENCE APPLICATION

c. Do not issue clearances which imply or indicate approval of rolling takeoffs by heavy jet aircraft except as provided in para 3-1-14, Ground Operations When Volcanic Ash is Present.

d. Do not issue clearances to a small aircraft to taxi into position and hold on the same runway behind a departing heavy jet aircraft to apply the necessary intervals.

REFERENCE-
AC 90-23, Aircraft Wake Turbulence.

e. The minima in para 5-5-4, Minima, may be applied in lieu of the 2 minute requirement in subpara f. When para 5-5-4, Minima, are applied, ensure that the appropriate radar separation exists at or prior to the time an aircraft becomes airborne when taking off behind a heavy jet/B757.

NOTE-
The pilot may request additional separation; i.e., 2 minutes vs. 4 miles, but should make this request before taxiing on the runway.

f. Separate IFR/VFR aircraft taking off behind a heavy jet/B757 departure by 2 minutes, when departing:

NOTE-
Takeoff clearance to the following aircraft should not be issued until 2 minutes after the heavy jet/B757 begins takeoff roll.

1. The same runway. (See FIG 3-9-4.)

FIG 3-9-4
2 Minute Separation

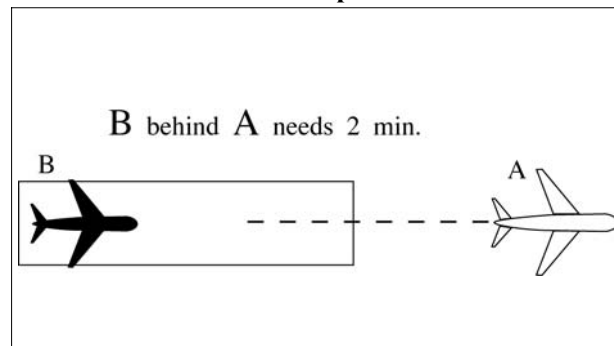

2. A parallel runway separated by less than 2,500 feet.

g. Separate an aircraft from a heavy jet/B757 when operating on a runway with a displaced landing threshold if projected flight paths will cross- 2 minutes when:

1. A departure follows a heavy jet/B757 arrival.
2. An arrival follows a heavy jet/B757 departure.

h. Air traffic controllers shall not approve pilot requests to deviate from the required wake turbulence time interval if the preceding aircraft is a heavy jet/B757.

i. Separate a small aircraft behind a large aircraft taking off or making a low/missed approach when utilizing opposite direction takeoffs on the same runway by 3 minutes unless a pilot has initiated a request to deviate from the 3-minute interval. In the latter case, issue a wake turbulence advisory before clearing the aircraft for takeoff.

NOTE-

1. A request for takeoff does not initiate a waiver request.
2. To initiate a waiver of the 3 minute rule, the request for takeoff must be accompanied by a request to deviate from the 3-minute rule.

REFERENCE-
FAAO 7110.65, Aircraft Information: Appendix A, Appendix B, and Appendix C.

j. Separate aircraft behind a heavy jet/B757 departing or making a low/missed approach when utilizing opposite direction takeoffs or landings on the same or parallel runways separated by less than 2,500 feet- 3 minutes.

k. Inform an aircraft when it is necessary to hold in order to provide the required 3-minute interval.

PHRASEOLOGY-
HOLD FOR WAKE TURBULENCE.

REFERENCE-

FAAO 7110.65, *Wake Turbulence Separation for Intersection Departures*, Para 3-9-7

3-9-7. WAKE TURBULENCE SEPARATION FOR INTERSECTION DEPARTURES

a. Apply the following wake turbulence criteria for intersection departures:

1. Separate a small aircraft taking off from an intersection on the same runway (same or opposite direction takeoff) behind a preceding departing large aircraft by ensuring that the small aircraft does not start takeoff roll until at least 3 minutes after the large aircraft has taken off.

2. Separate any aircraft taking off from an intersection on the same runway (same or opposite direction takeoff), parallel runways separated by less than 2,500 feet, and parallel runways separated by less than 2,500 feet with runway thresholds offset by 500 feet or more, by ensuring that the aircraft does not start takeoff roll until at least 3 minutes after a heavy aircraft/B757 has taken off.

NOTE-

Parallel runways separated by less than 2,500 feet with runway thresholds offset by less than 500 feet shall apply para 3-9-6 Same Runway Separation, subpara f.

3. Separate a small aircraft weighing 12,500 lbs. or less taking off from an intersection on the same runway (same or opposite direction takeoff) behind a preceding small aircraft weighing more than 12,500 lbs. by ensuring the following small aircraft does not start takeoff roll until at least 3 minutes after the preceding aircraft has taken off.

4. Inform an aircraft when it is necessary to hold in order to provide the required 3-minute interval.

PHRASEOLOGY-

HOLD FOR WAKE TURBULENCE.

NOTE-

Aircraft conducting touch-and-go and stop-and-go operations are considered to be departing from an intersection.

REFERENCE-

FAAO 7110.65, *Touch-and-Go or Stop-and-Go or Low Approach*, Para 3-8-2

b. The 3-minute interval is not required when:

1. A pilot has initiated a request to deviate from that interval unless the preceding departing aircraft is a heavy aircraft/B757.

NOTE-

A request for takeoff does not initiate a waiver request; the request for takeoff must be accomplished by a request to deviate from the 3-minute interval.

2. USA NOT APPLICABLE. The intersection is 500 feet or less from the departure point of the preceding aircraft and both aircraft are taking off in the same direction.

3. Successive touch-and-go and stop-and-go operations are conducted with a small aircraft following another small aircraft weighing more than 12,500 lbs. or a large aircraft in the pattern, or a small aircraft weighing more than 12,500 lbs. or a large aircraft departing the same runway, provided the pilot of the small aircraft is maintaining visual separation/spacing behind the preceding large aircraft. Issue a wake turbulence cautionary advisory and the position of the large aircraft.

EXAMPLE-

"Caution wake turbulence, DC-9 on base leg."

4. Successive touch-and-go and stop-and-go operations are conducted with any aircraft following a heavy aircraft/B757 in the pattern, or heavy aircraft/B757 departing the same runway, provided the pilot of the aircraft is maintaining visual separation/spacing behind the preceding heavy aircraft/B757. Issue a wake turbulence cautionary advisory and the position of the heavy aircraft/B757.

EXAMPLE-

"Caution wake turbulence, heavy Lockheed C5A departing runway two three."

5. If action is initiated to reduce the separation between successive touch-and-go or stop-and-go operations, apply 3 minutes separation.

c. When applying the provision of subpara b:

1. Issue a wake turbulence advisory before clearing the aircraft for takeoff.

2. Do not clear the intersection departure for an immediate takeoff.

3. Issue a clearance to permit the trailing aircraft to deviate from course enough to avoid the flight path of the preceding large departure when applying subpara b1 or b2.

4. Separation requirements in accordance with para 3-9-6, Same Runway Separation, must also apply.

REFERENCE-

FAAO 7110.65, *Same Runway Separation*, Para 3-9-6

3-9-8. INTERSECTING RUNWAY SEPARATION

Separate departing aircraft from an aircraft using an intersecting runway, or nonintersecting runways when the flight paths intersect, by ensuring that the departure does not begin takeoff roll until one of the following exists:

REFERENCE-

FAAO 7110.65, Traffic Advisories, Para 2-1-21

- a. The preceding aircraft has departed and passed the intersection, has crossed the departure runway, or is turning to avert any conflict. (See FIG 3-9-5 and FIG 3-9-6.)

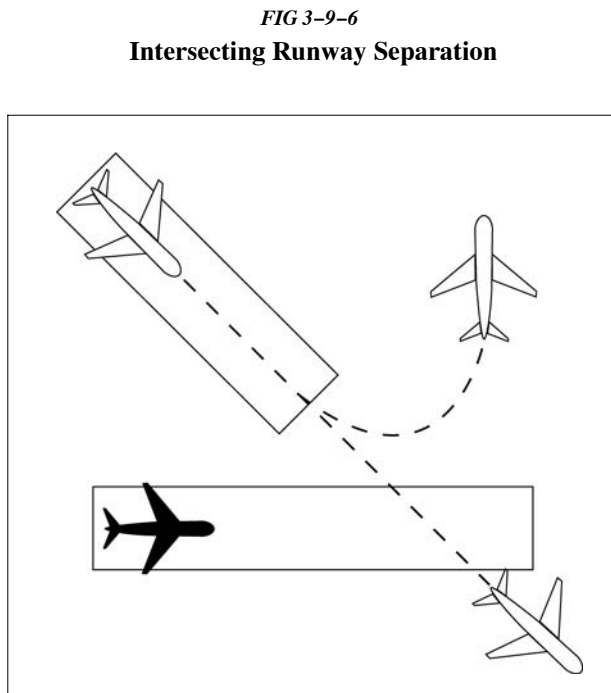
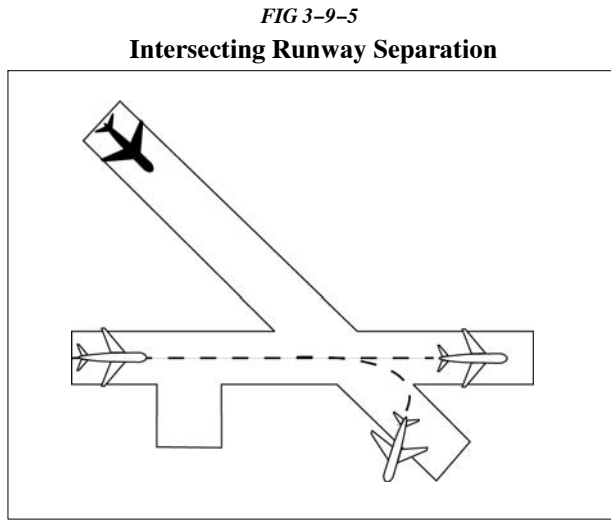

- b. A preceding arriving aircraft is clear of the landing runway, completed the landing roll and will hold short of the intersection, passed the intersection, or has crossed over the departure runway. (See FIG 3-9-7 and FIG 3-9-8.)

REFERENCE-

P/CG Term- Clear of the Runway.

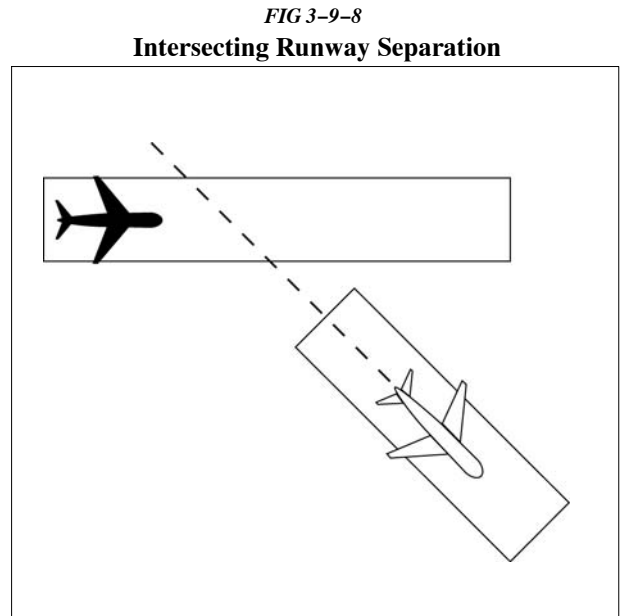
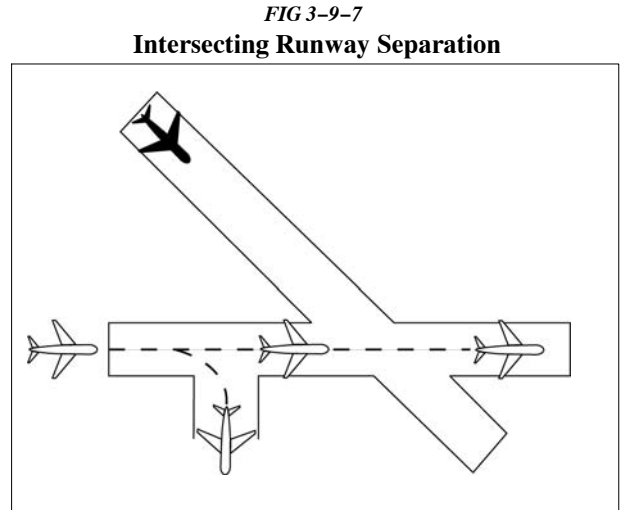

WAKE TURBULENCE APPLICATION

- c. Separate IFR/VFR aircraft taking off behind a heavy jet/B757 departure by 2 minutes when departing:

NOTE-

Takeoff clearance to the following aircraft should not be issued until 2 minutes after the heavy jet/B757 begins takeoff roll.

1. Crossing runways if projected flight paths will cross. (See FIG 3-9-9.)

FIG 3-9-9
Crossing Runways

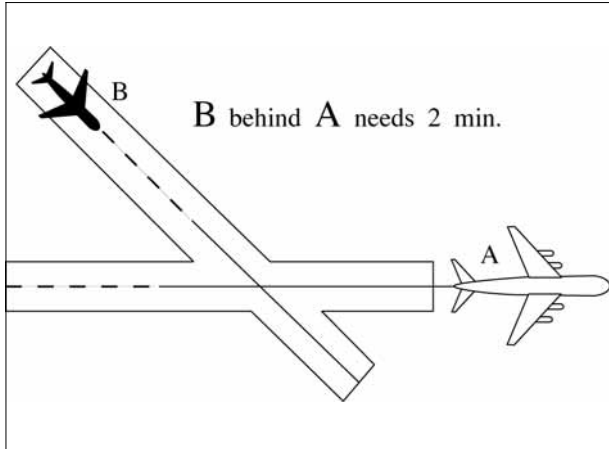

2. A parallel runway separated by 2,500 feet or more if projected flight paths will cross. (See FIG 3-9-10.)

FIG 3-9-10
Parallel Runway

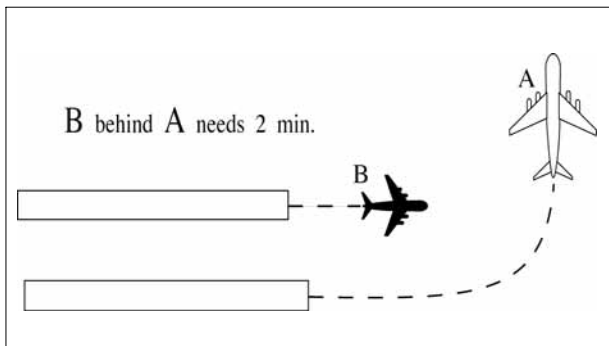

d. Separate IFR/VFR aircraft departing behind a landing heavy jet/B757 on a crossing runway if the departure will fly through the airborne path of the arrival—2 minutes. (See FIG 3-9-11.)

FIG 3-9-11
Departure on Crossing Runway

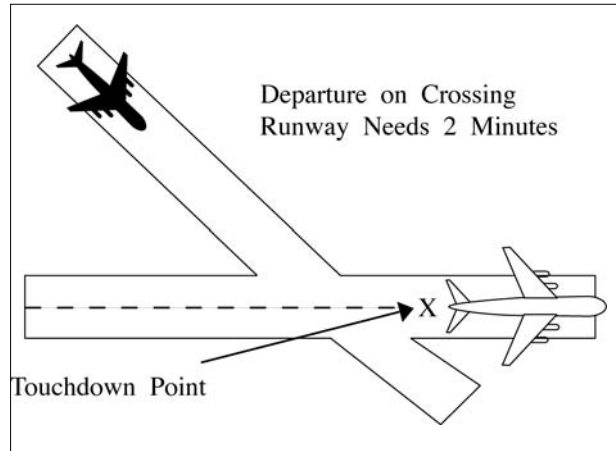

e. Air traffic controllers shall not approve pilot requests to deviate from the required wake turbulence time interval if the preceding aircraft is a heavy jet/B757.

REFERENCE—
FAAO 7110.65, Successive or Simultaneous Departures, Para 5-8-3
FAAO 7110.65, Departures and Arrivals on Parallel or Nonintersecting Diverging Runways, Para 5-8-5

3-9-9. TAKEOFF CLEARANCE

a. When only one runway is active, issue takeoff clearance.

PHRASEOLOGY—
CLEARED FOR TAKEOFF.

NOTE—
Turbine-powered aircraft may be considered ready for takeoff when they reach the runway unless they advise otherwise.

REFERENCE—
FAAO 7110.65, Departure Terminology, Para 4-3-1

b. When more than one runway is active, first state the runway number followed by the takeoff clearance.

PHRASEOLOGY—
RUNWAY (number), CLEARED FOR TAKEOFF.

EXAMPLE—
“RUNWAY TWO SEVEN, CLEARED FOR TAKEOFF.”

c. USA/USN. Issue surface wind and takeoff clearance to aircraft.

PHRASEOLOGY—
WIND (surface wind in direction and velocity).
CLEARED FOR TAKEOFF.

d. USAF. When an aircraft is cleared for takeoff, inform it of the closest traffic within 6 miles on final approach to the same runway. If the approaching aircraft is on a different frequency, inform it of the departing aircraft.

3-9-10. CANCELLATION OF TAKEOFF CLEARANCE

Cancel a previously issued clearance for takeoff and inform the pilot of the reason if circumstances

require. Once an aircraft has started takeoff roll, cancel the takeoff clearance only for the purpose of safety.

NOTE-

In no case should a takeoff clearance be canceled after an aircraft has started its takeoff roll solely for the purpose of meeting traffic management requirements/EDCT.

PHRASEOLOGY-

CANCEL TAKEOFF CLEARANCE (reason).

Section 10. Arrival Procedures and Separation

3-10-1. LANDING INFORMATION

Provide current landing information, as appropriate, to arriving aircraft. Landing information contained in the ATIS broadcast may be omitted if the pilot states the appropriate ATIS code. Runway, wind, and altimeter may be omitted if a pilot uses the phrase “have numbers.” Issue landing information by including the following:

NOTE-

Pilot use of “have numbers” does not indicate receipt of the ATIS broadcast.

a. Specific traffic pattern information (may be omitted if the aircraft is to circle the airport to the left).

PHRASEOLOGY-

ENTER LEFT/RIGHT BASE.

STRAIGHT-IN.

MAKE STRAIGHT-IN.

STRAIGHT-IN APPROVED.

RIGHT TRAFFIC.

MAKE RIGHT TRAFFIC.

RIGHT TRAFFIC APPROVED. CONTINUE.

- b. Runway in use.
- c. Surface wind.
- d. Altimeter setting.

REFERENCE-

FAAO 7110.65, Current Settings, Para 2-7-1

- e. Any supplementary information.
- f. Clearance to land.

g. Requests for additional position reports. Use prominent geographical fixes which can be easily recognized from the air, preferably those depicted on sectional charts. This does not preclude the use of the legs of the traffic pattern as reporting points.

NOTE-

At some locations, VFR checkpoints are depicted on sectional aeronautical and terminal area charts. In selecting geographical fixes, depicted VFR checkpoints are preferred unless the pilot exhibits a familiarity with the local area.

h. Ceiling and visibility if either is below basic VFR minima.

i. Low level wind shear or microburst advisories when available.

REFERENCE-

FAAO 7110.65, Low Level Wind Shear/Microburst Advisories, Para 3-1-8

j. Issue braking action for the runway in use as received from pilots or the airport management when Braking Action Advisories are in effect.

REFERENCE-

FAAO 7110.65, Braking Action Advisories, Para 3-3-5

3-10-2. FORWARDING APPROACH INFORMATION BY NONAPPROACH CONTROL FACILITIES

a. Forward the following, as appropriate, to the control facility having IFR jurisdiction in your area. You may eliminate those items that, because of local conditions or situations, are fully covered in a letter of agreement or a facility directive.

1. When you clear an arriving aircraft for a visual approach.

REFERENCE-

FAAO 7110.65, Visual Approach, Para 7-4-1

- 2. Aircraft arrival time.
- 3. Cancellation of IFR flight plan.
- 4. Information on a missed approach, unreported, or overdue aircraft.
- 5. Runway in use.
- 6. Weather as required.

REFERENCE-

FAAO 7110.65, Reporting Weather Conditions, Para 2-6-6

b. When the weather is below 1,000 feet or 3 miles or the highest circling minimums, whichever is greater, issue current weather to aircraft executing an instrument approach if it changes from that on the ATIS or that previously forwarded to the center/approach control.

3-10-3. SAME RUNWAY SEPARATION

a. Separate an arriving aircraft from another aircraft using the same runway by ensuring that the arriving aircraft does not cross the landing threshold until one of the following conditions exists or unless authorized in para 3-10-10, Altitude Restricted Low Approach.

1. The other aircraft has landed and is clear of the runway. (See FIG 3-10-1.) Between sunrise and sunset, if you can determine distances by reference to suitable landmarks and the other aircraft has landed, it need not be clear of the runway if the following minimum distance from the landing threshold exists:

REFERENCE-
P/CG Term- *Clear of the Runway.*

FIG 3-10-1

Same Runway Separation

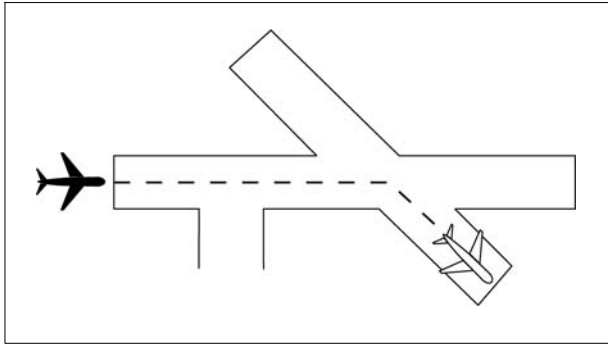

(a) When a Category I aircraft is landing behind a Category I or II- 3,000 feet. (See FIG 3-10-2.)

FIG 3-10-2

Same Runway Separation

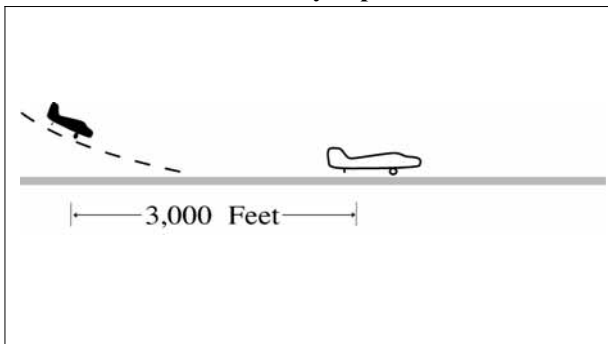

(b) When a Category II aircraft is landing behind a Category I or II- 4,500 feet. (See FIG 3-10-3.)

FIG 3-10-3

Same Runway Separation

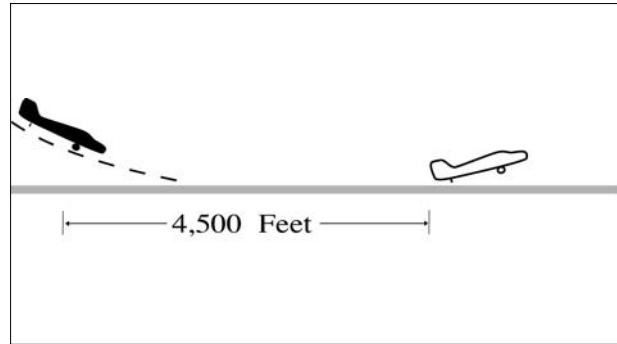

2. The other aircraft has departed and crossed the runway end. (See FIG 3-10-4). If you can determine distances by reference to suitable landmarks and the other aircraft is airborne, it need not have crossed the runway end if the following minimum distance from the landing threshold exists:

(a) Category I aircraft landing behind Category I or II- 3,000 feet.

(b) Category II aircraft landing behind Category I or II- 4,500 feet.

(c) When either is a category III aircraft- 6,000 feet. (See FIG 3-10-5.)

FIG 3-10-4

Same Runway Separation

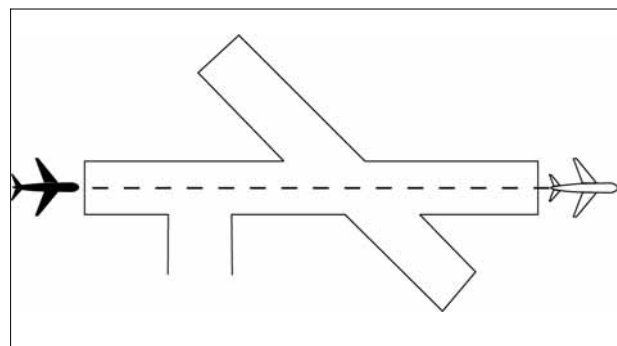

**FIG 3-10-5
Same Runway Separation**

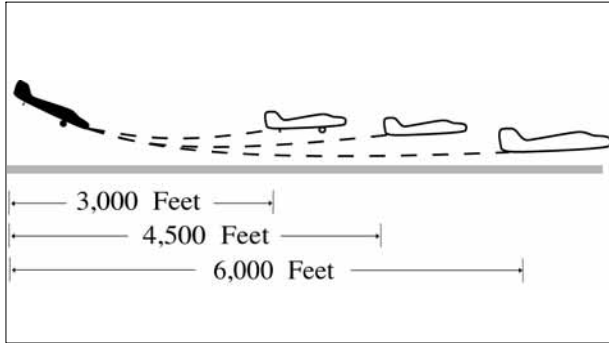

3. When the succeeding aircraft is a helicopter, visual separation may be applied in lieu of using distance minima.

WAKE TURBULENCE APPLICATION

b. Issue wake turbulence advisories, and the position, altitude if known, and the direction of flight of:

1. The heavy jet/B757 to aircraft landing behind a departing/arriving heavy jet/B757 on the same or parallel runways separated by less than 2,500 feet.
2. The large aircraft to a small aircraft landing behind a departing/arriving large aircraft on the same or parallel runways separated by less than 2,500 feet.

REFERENCE-
AC 90-23, Aircraft Wake Turbulence, Pilot Responsibility, Para 12.
FAAO 7110.65, Altitude Restricted Low Approach, Para 3-10-10

EXAMPLE-

1. "Runway two seven left cleared to land, caution wake turbulence, heavy Boeing 747 departing runway two seven right."
2. "Number two follow Boeing 757 on two-mile final. Caution wake turbulence."

3-10-4. INTERSECTING RUNWAY SEPARATION

a. Separate an arriving aircraft using one runway from another aircraft using an intersecting runway or a nonintersecting runway when the flight paths intersect by ensuring that the arriving aircraft does not cross the landing threshold or flight path of the

other aircraft until one of the following conditions exists:

REFERENCE-
FAAO 7110.65, Traffic Advisories, Para 2-1-21

1. The preceding aircraft has departed and passed the intersection/flight path or is airborne and turning to avert any conflict.
(See FIG 3-10-6 and FIG 3-10-7.)

**FIG 3-10-6
Intersecting Runway Separation**

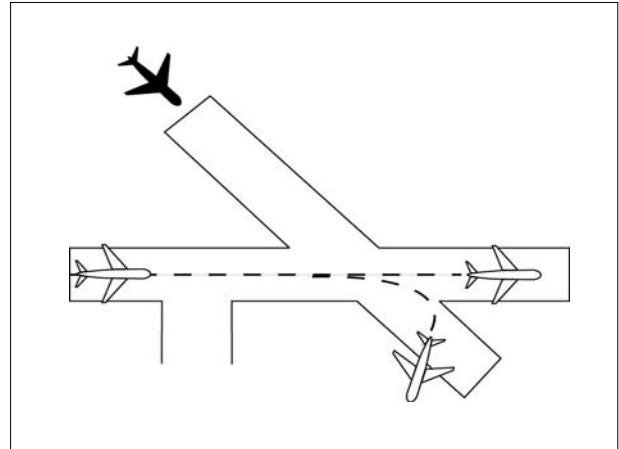

**FIG 3-10-7
Intersecting Runway Separation**

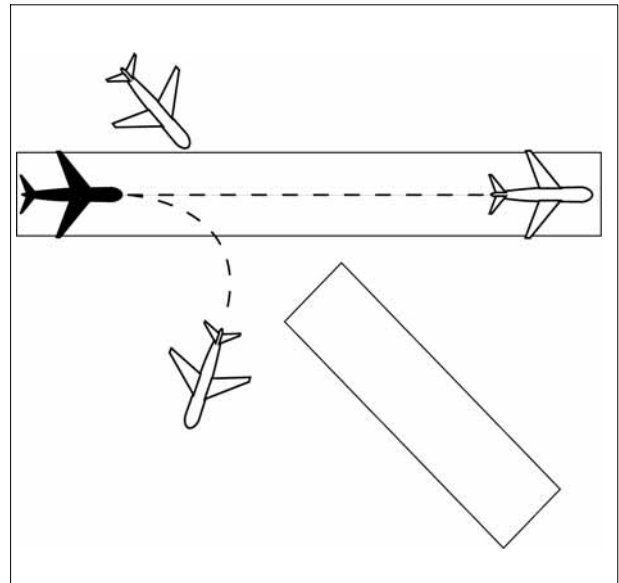

2. A preceding arriving aircraft is clear of the landing runway, completed landing roll and will hold short of the intersection/flight path, or has passed the intersection/flight path.

(See FIG 3-10-8 and FIG 3-10-9.)

FIG 3-10-8

Intersection Runway Separation

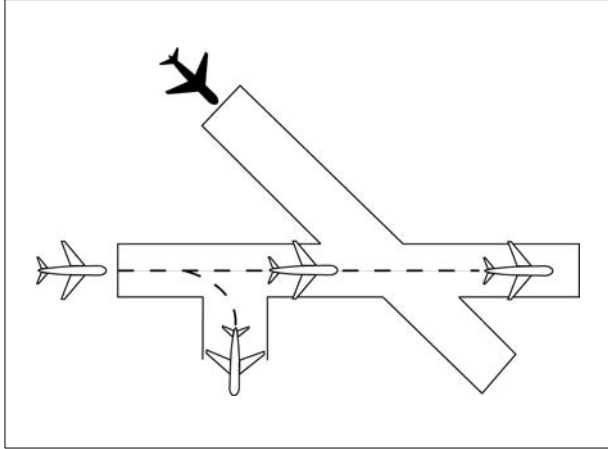
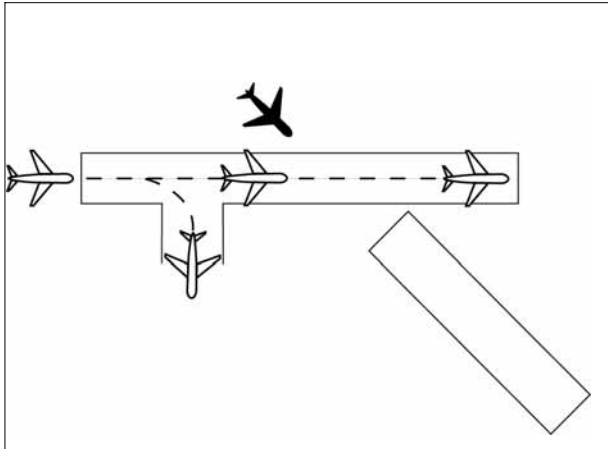

FIG 3-10-9

Intersection Runway Separation



b. "USA/USAF/USN NOT APPLICABLE." An aircraft may be authorized to takeoff from one runway while another aircraft lands simultaneously on an intersecting runway or an aircraft lands on one runway while another aircraft lands simultaneously on an intersecting runway, or an aircraft lands to hold short of an intersecting taxiway or some other predetermined point such as an approach/departure flight path using procedures specified in the current LAHSO directive. The procedure shall be approved by the air traffic manager and be in accordance with a facility directive. The following conditions apply:

NOTE-

Application of these procedures does not relieve controllers from the responsibility of providing other appropriate separation contained in this order.

REFERENCE-

FAAO 7210.3, Land and Hold Short Operations (LAHSO), Para 10-3-7.

1. A simultaneous takeoff and landing operation shall only be conducted in VFR conditions.

2. Instruct the landing aircraft to hold short of the intersecting runway being used by the aircraft taking off. In the case of simultaneous landings and no operational benefit is lost, restrict the aircraft of the lesser weight category (if known). LAHSO clearances shall only be issued to aircraft that are listed in the current LAHSO directive, whose Available Landing Distance (ALD) does not exceed the landing distance requirement for the runway condition.

PHRASEOLOGY-

HOLD SHORT OF RUNWAY (runway number), (traffic, type aircraft or other information).

NOTE-

Pilots who prefer to use the full length of the runway or a runway different from that specified are expected to advise ATC prior to landing.

3. Issue traffic information to both aircraft involved and obtain an acknowledgment from each. Request a read back of hold short instructions when they are not received from the pilot of the restricted aircraft.

EXAMPLE-

1. "Runway one eight cleared to land, hold short of runway one four left, traffic, (type aircraft) landing runway one four left."

(When pilot of restricted aircraft responds with only acknowledgment):

"Runway one four left cleared to land, traffic, (type aircraft) landing runway one eight will hold short of the intersection."

"Read back hold short instructions."

2. "Runway three six cleared to land, hold short of runway three three, traffic, (type aircraft) departing runway three three."

"Traffic, (type aircraft) landing runway three six will hold short of the intersection, runway three three cleared for takeoff."

4. Issue the measured distance from the landing threshold to the hold short point rounded “down” to the nearest 50-foot increment if requested by either aircraft.

EXAMPLE-
 “Five thousand fifty feet available.”

5. The conditions in subparas b2, 3, and 4 shall be met in sufficient time for the pilots to take other action, if desired, and no later than the time landing clearance is issued.

6. Land and Hold Short runways must be free of any contamination as described in the current LAHSO directive, with no reports that braking action is less than good.

7. There is no tailwind for the landing aircraft restricted to hold short of the intersection. The wind may be described as “calm” when appropriate.

REFERENCE-
 FAAO 7110.65, *Calm Wind Conditions, Para 2-6-5*

8. The aircraft required landing distances are listed in the current LAHSO directive.

9. STOL aircraft operations are in accordance with a letter of agreement with the aircraft operator/pilot or the pilot confirms that it is a STOL aircraft.

WAKE TURBULENCE APPLICATION

c. Separate IFR/VFR aircraft landing behind a departing heavy jet/B757 on a crossing runway if the arrival will fly through the airborne path of the departure— 2 minutes or the appropriate radar separation minima. (See FIG 3-10-10.)

d. Issue wake turbulence cautionary advisories, the position, altitude if known, and direction of flight of the heavy jet/B757 to:

REFERENCE-
 AC 90-23, *Aircraft Wake Turbulence, Pilot Responsibility, Para 12.*

FIG 3-10-10
Intersecting Runway Separation

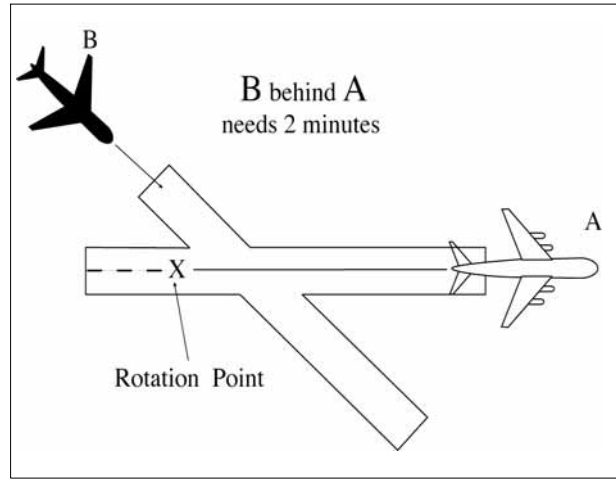

1. IFR/VFR aircraft landing on crossing runways behind a departing heavy jet/B757; if the arrival flight path will cross the takeoff path behind the heavy jet/B757 and behind the heavy jet/B757 rotation point. (See FIG 3-10-11.)

FIG 3-10-11
Intersecting Runway Separation

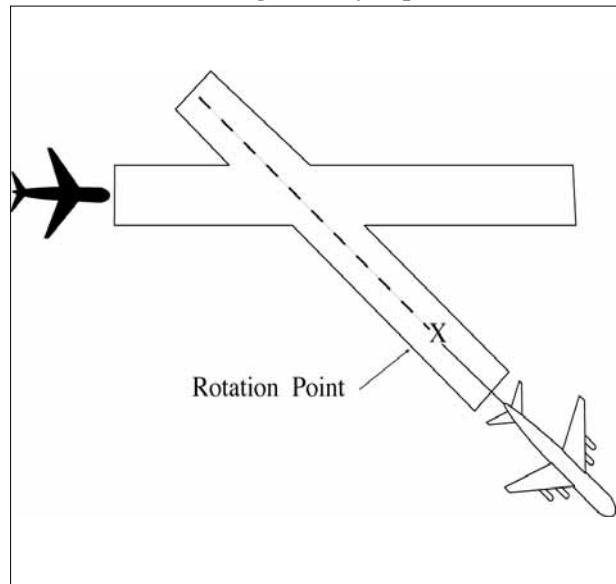

EXAMPLE-
 “Runway niner cleared to land. Caution wake turbulence, heavy C-One Forty One departing runway one five.”

2. VFR aircraft landing on a crossing runway behind an arriving heavy jet/B757 if the arrival flight path will cross. (See FIG 3-10-12.)

FIG 3-10-12

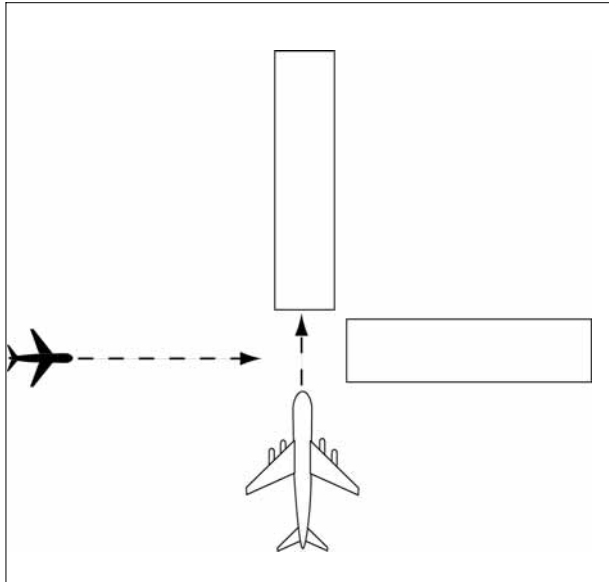
Intersecting Runway Separation**EXAMPLE-**

“Runway niner cleared to land. Caution wake turbulence, Boeing Seven Fifty Seven landing runway three six.”

REFERENCE-

FAAO 7110.65, *Approaches to Multiple Runways*, Para 7-4-4

3-10-5. LANDING CLEARANCE

a. Issue landing clearance. Restate the landing runway whenever more than one runway is active, or an instrument approach is being conducted to a closed runway.

PHRASEOLOGY-
CLEARED TO LAND,

or

RUNWAY (designator) CLEARED TO LAND.

b. “USN NOT APPLICABLE.” Inform the closest aircraft that is cleared to land, touch-and-go, stop-and-go, or unrestricted low approaches when there is traffic holding on the same runway.

EXAMPLE-

“Delta One, cleared to land. Traffic holding in position.”

or

“Delta One, runway one eight, cleared to land. Traffic holding in position.”

c. USA/USN. Issue surface wind when clearing an aircraft to land, touch-and-go, stop-and-go, low approach, or the option. Restate the landing runway whenever there is a possibility of a conflict with another aircraft which is using or is planning to use another runway.

PHRASEOLOGY-

WIND (surface wind direction and velocity), CLEARED TO LAND,

or

WIND (surface wind direction and velocity), RUNWAY (designator) CLEARED TO LAND.

NOTE-

A clearance to land means that appropriate separation on the landing runway will be ensured. A landing clearance does not relieve the pilot from compliance with any previously issued restriction.

3-10-6. ANTICIPATING SEPARATION

Landing clearance to succeeding aircraft in a landing sequence need not be withheld if you observe the positions of the aircraft and determine that prescribed runway separation will exist when the aircraft cross the landing threshold. Issue traffic information to the succeeding aircraft if not previously reported and appropriate traffic holding in position or departing prior to their arrival.

EXAMPLE-

“American Two Forty-Five cleared to land, number two following United Boeing Seven-Thirty-Seven two mile final, traffic will depart prior to your arrival.”

“American Two Forty-Five cleared to land, number two following United Boeing Seven-Thirty-Seven two mile final, traffic will be an MD 88 holding in position.”

“American Two Forty-Five cleared to land, following United Boeing Seven-Thirty-Seven two mile final, traffic will depart prior to your arrival.”

NOTE-

Landing sequence number is optional at tower facilities where arrivals are sequenced by the approach control.

REFERENCE-

FAAO 7110.65, *Closed/Unsafe Runway Information*, Para 3-3-2

FAAO 7110.65, *Landing Clearance*, Para 3-10-5b, not required if utilizing the provisions of Para 3-10-6.

3-10-7. LANDING CLEARANCE WITHOUT VISUAL OBSERVATION

When an arriving aircraft reports at a position where he/she should be seen but has not been visually observed, advise the aircraft as a part of the landing clearance that it is not in sight and restate the landing runway.

PHRASEOLOGY-

NOT IN SIGHT, RUNWAY (number) CLEARED TO LAND.

NOTE-

Aircraft observance on the CTRD satisfies the visually observed requirement.

3-10-8. WITHHOLDING LANDING CLEARANCE

Do not withhold a landing clearance indefinitely even though it appears a violation of Title 14 of the Code of Federal Regulations has been committed. The apparent violation might be the result of an emergency situation. In any event, assist the pilot to the extent possible.

3-10-9. RUNWAY EXITING

a. Instruct aircraft where to turn-off the runway after landing, when appropriate, and advise the aircraft to hold short of a runway or taxiway if required for traffic.

PHRASEOLOGY-

TURN LEFT/RIGHT (taxiway/runway),

or

IF ABLE, TURN LEFT/RIGHT (taxiway/runway)

and if required

HOLD SHORT OF (runway).

NOTE-

Runway exiting or taxi instructions should not normally be issued to an aircraft prior to, or immediately after, touchdown.

b. Taxi instructions shall be provided to the aircraft by the local controller when:

1. Compliance with ATC instructions will be required before the aircraft can change to ground control, or

2. The aircraft will be required to enter an active runway in order to taxi clear of the landing runway.

EXAMPLE-

“U.S. Air Ten Forty Two, turn right next taxiway, cross runway two one, contact ground point seven.”

“U.S. Air Ten Forty Two, turn right on Alfa/next taxiway, cross Bravo, hold short of Charlie, contact ground point seven.”

NOTE-

1. An aircraft is expected to taxi clear of the runway unless otherwise directed by ATC. Pilots shall not exit the landing runway on to an intersecting runway unless authorized by ATC. In the absence of ATC instructions, an aircraft should taxi clear of the landing runway by clearing the hold position marking associated with the landing runway even if that requires the aircraft to protrude into or enter another taxiway/ramp area. This does not authorize an aircraft to cross a subsequent taxiway or ramp after clearing the landing runway.

2. The pilot is responsible for ascertaining when the aircraft is clear of the runway by clearing the hold position marking associated with the landing runway.

c. Ground control and local control shall protect a taxiway/runway/ramp intersection if an aircraft is required to enter that intersection to clear the landing runway.

REFERENCE-

FAAO 7210.3, Use of Active Runways, Para 10-1-7.

d. Request a read back of runway hold short instructions when not received from the pilot.

EXAMPLE-

“American Four Ninety-two, turn left at Taxiway Charlie, hold short of Runway 27 Right.”

or

“American Four Ninety-two, turn left at Charlie, hold short of Runway 27 Right.”

“American Four Ninety Two, Roger.”

“American Four Ninety-two, read back hold instructions.”

NOTE-

Read back hold instructions phraseology may be initiated for any point on a movement area when the controller believes the read back is necessary.

3-10-10. ALTITUDE RESTRICTED LOW APPROACH

A low approach with an altitude restriction of not less than 500 feet above the airport may be authorized except over an aircraft in takeoff position or a departure aircraft. Do not clear aircraft for restricted altitude low approaches over personnel unless airport authorities have advised these personnel that the approaches will be conducted. Advise the approaching aircraft of the location of applicable ground traffic, personnel, or equipment.

NOTE-

1. The 500 feet restriction is a minimum. Higher altitudes should be used when warranted. For example, 1,000 feet is more appropriate for heavy aircraft operating over unprotected personnel or small aircraft on or near the runway.

2. This authorization includes altitude restricted low approaches over preceding landing or taxiing aircraft. Restricted low approaches are not authorized over aircraft in takeoff position or departing aircraft.

PHRASEOLOGY-

CLEARED LOW APPROACH AT OR ABOVE (altitude). TRAFFIC (description and location).

REFERENCE-

FAAO 7110.65, Vehicles/Equipment/Personnel on Runways, Para 3-1-5
FAAO 7110.65, Traffic Information, Para 3-1-6
FAAO 7110.65, Light Signals, Para 3-2-1
FAAO 7110.65, Timely Information, Para 3-3-3
FAAO 7110.65, Taxi into Position and Hold (TIPH), Para 3-9-4
FAAO 7110.65, Same Runway Separation, Para 3-10-3

3-10-11. CLOSED TRAFFIC

Approve/disapprove pilot requests to remain in closed traffic for successive operations subject to local traffic conditions.

PHRASEOLOGY-

LEFT/RIGHT (if required) CLOSED TRAFFIC APPROVED. REPORT (position if required),

or

UNABLE CLOSED TRAFFIC, (additional information as required).

NOTE-

Segregated traffic patterns for helicopters to runways and other areas may be established by letter of agreement or other local operating procedures.

REFERENCE-

FAAO 7110.65, Runway Proximity, Para 3-7-4
FAAO 7110.65, Taxi into Position and Hold (TIPH), Para 3-9-4
FAAO 7110.65, Same Runway Separation, Para 3-10-3

3-10-12. OVERHEAD MANEUVER

Issue the following to arriving aircraft that will conduct an overhead maneuver:

a. Pattern altitude and direction of traffic. Omit either or both if standard or when you know the pilot is familiar with a nonstandard procedure.

PHRASEOLOGY-

PATTERN ALTITUDE (altitude). RIGHT TURNS.

b. Request for report on initial approach.

PHRASEOLOGY-

REPORT INITIAL.

c. "Break" information and request for pilot report. Specify the point of "break" only if nonstandard. Request the pilot to report "break" if required for traffic or other reasons.

PHRASEOLOGY-

BREAK AT (specified point).

REPORT BREAK.

d. Overhead maneuver patterns are developed at airports where aircraft have an operational need to conduct the maneuver. An aircraft conducting an overhead maneuver is on VFR and the IFR flight plan is cancelled when the aircraft reaches the "initial point" on the initial approach portion of the maneuver. The existence of a standard overhead maneuver pattern does not eliminate the possible requirement for an aircraft to conform to conventional rectangular patterns if an overhead maneuver cannot be approved.

NOTE-

Aircraft operating to an airport without a functioning control tower must initiate cancellation of the IFR flight plan prior to executing the overhead maneuver or after landing.

FIG 3-10-13
Overhead Maneuver

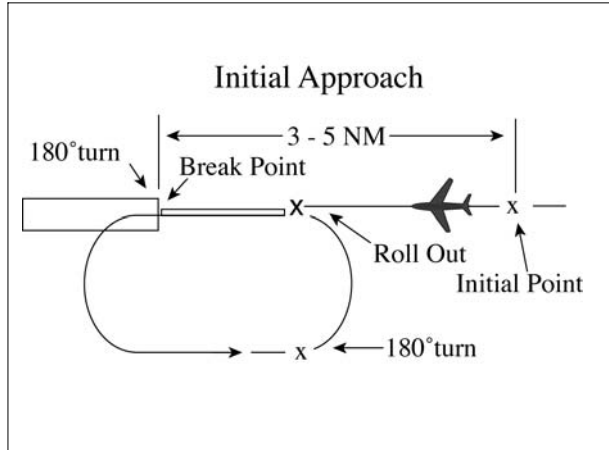

EXAMPLE-

“Air Force Three Six Eight, Runway Six, wind zero seven zero at eight, pattern altitude six thousand, report initial.”

“Air Force Three Six Eight, break at midfield, report break.”

“Air Force Three Six Eight, cleared to land.”

“Alfa Kilo Two Two, Runway Three One, wind three three zero at one four, right turns, report initial.”

“Alfa Kilo Two Two, report break.”

“Alfa Kilo Two Two, cleared to land.”

e. Timely and positive controller action is required to prevent a conflict when an overhead pattern could extend into the path of a departing or a missed approach aircraft. Local procedures and/or coordination requirements should be set forth in an appropriate letter of agreement, facility directive, base flying manual etc., when the frequency of occurrence warrants.

3-10-13. SIMULATED FLAMEOUT (SFO) APPROACHES/EMERGENCY LANDING PATTERN (ELP) OPERATIONS/PRACTICE PRECAUTIONARY APPROACHES

a. Authorize military aircraft to make SFO/ELP/practice precautionary approaches if the following conditions are met:

1. A letter of agreement or local operating procedure is in effect between the military flying organization and affected ATC facility.

(a) Include specific coordination, execution, and approval procedures for the operation.

(b) The exchange or issuance of traffic information as agreed to in any interfacility letter of agreement is accomplished.

(c) Include a statement in the procedure that clarifies at which points SFOs/ELPs may/may not be terminated. (See FIG 3-10-14 and FIG 3-10-16.)

2. Traffic information regarding aircraft in radio communication with or visible to tower controllers which are operating within or adjacent to the flameout maneuvering area is provided to the SFO/ELP aircraft and other concerned aircraft.

3. The high-key altitude or practice precautionary approach maneuvering altitudes of the aircraft concerned are obtained prior to approving the approach. (See FIG 3-10-14 and FIG 3-10-16.)

NOTE-

1. Practice precautionary/SFO/ELP approaches are authorized only for specific aircraft. Any aircraft, however, might make precautionary approaches, when engine failure is considered possible. The practice precautionary approach maneuvering area/altitudes may not conform to the standard SFO/ELP maneuvering area/altitudes.

2. SFO/ELP approaches generally require high descent rates. Visibility ahead and beneath the aircraft is greatly restricted.

3. Pattern adjustments for aircraft conducting SFOs and ELPs may impact the effectiveness of SFO and ELP training.

REFERENCE-

FAAO 7110.65, Low Approach and Touch-and-Go, Para 4-8-12
FAAO 7610.4, Simulated Flameout (SFO)/Emergency Landing Pattern (ELP) Operations, Para 9-3-7.

b. For overhead SFO/ELP approaches:

1. Request a report at the entry point.

PHRASEOLOGY-

REPORT (high or low) KEY (as appropriate).

2. Request a report at low key.

PHRASEOLOGY-

REPORT LOW KEY.

3. At low key, issue low approach clearance or alternate instructions.

REFERENCE-

FAAO 7110.65, Sequence/Spacing Application, Para 3-8-1
FAAO 7110.65, Inflight Emergencies Involving Military Fighter-type Aircraft, Para 10-1-7
FAAO 7610.4, Simulated Flameout (SFO)/Emergency Landing Pattern (ELP) Operations, Para 9-3-7.

c. For straight-in simulation flameout approaches:

1. Request a position report from aircraft conducting straight-in SFO approaches.

PHRASEOLOGY-
REPORT (distance) MILE SIMULATED FLAMEOUT FINAL.

FIG 3-10-14
Simulated Flameout [1]

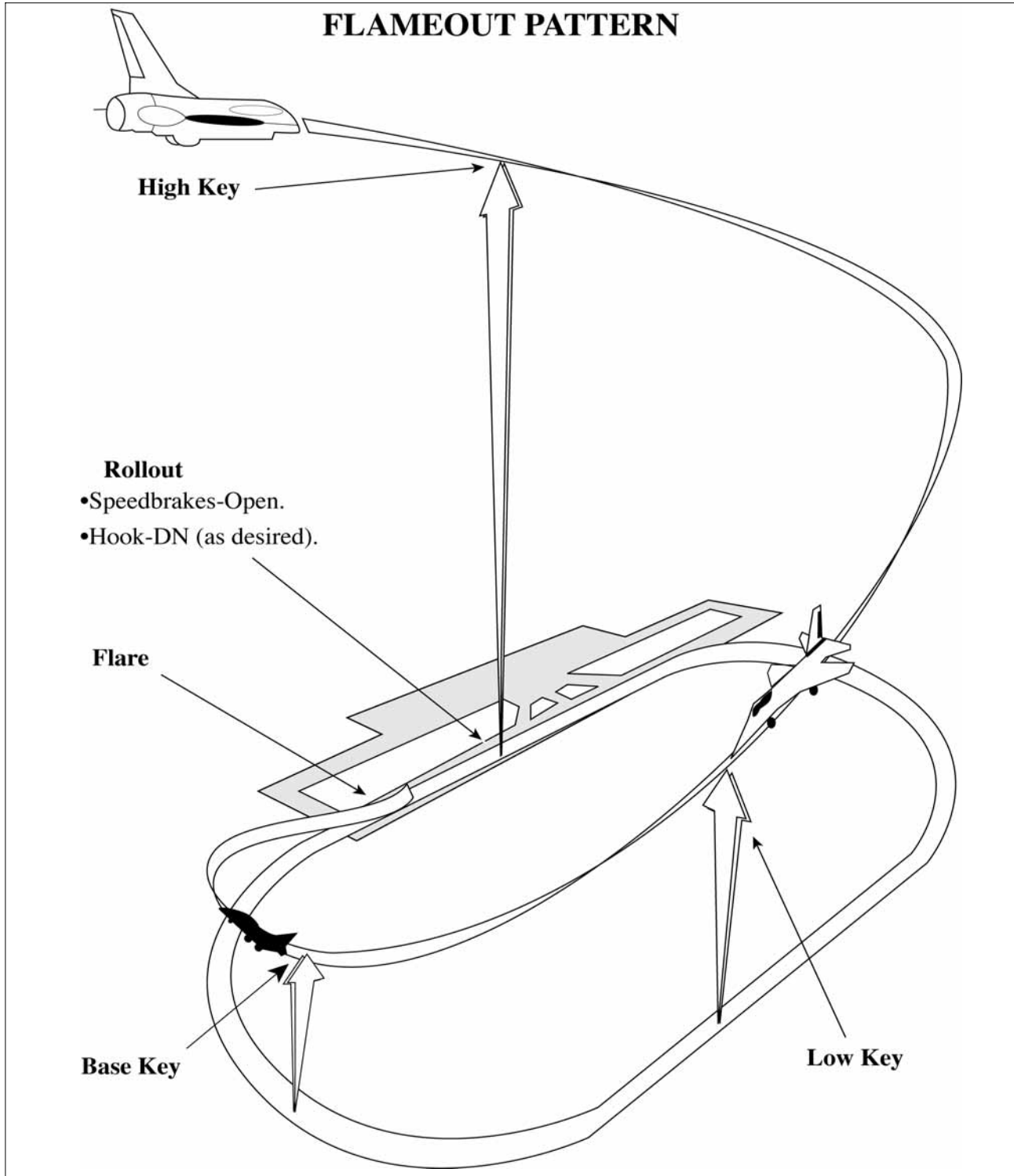

2. At the appropriate position on final (normally no closer than 3 miles), issue low approach clearance or alternate instruction. (See FIG 3-10-15.)

FIG 3-10-15
Simulated Flameout [2]

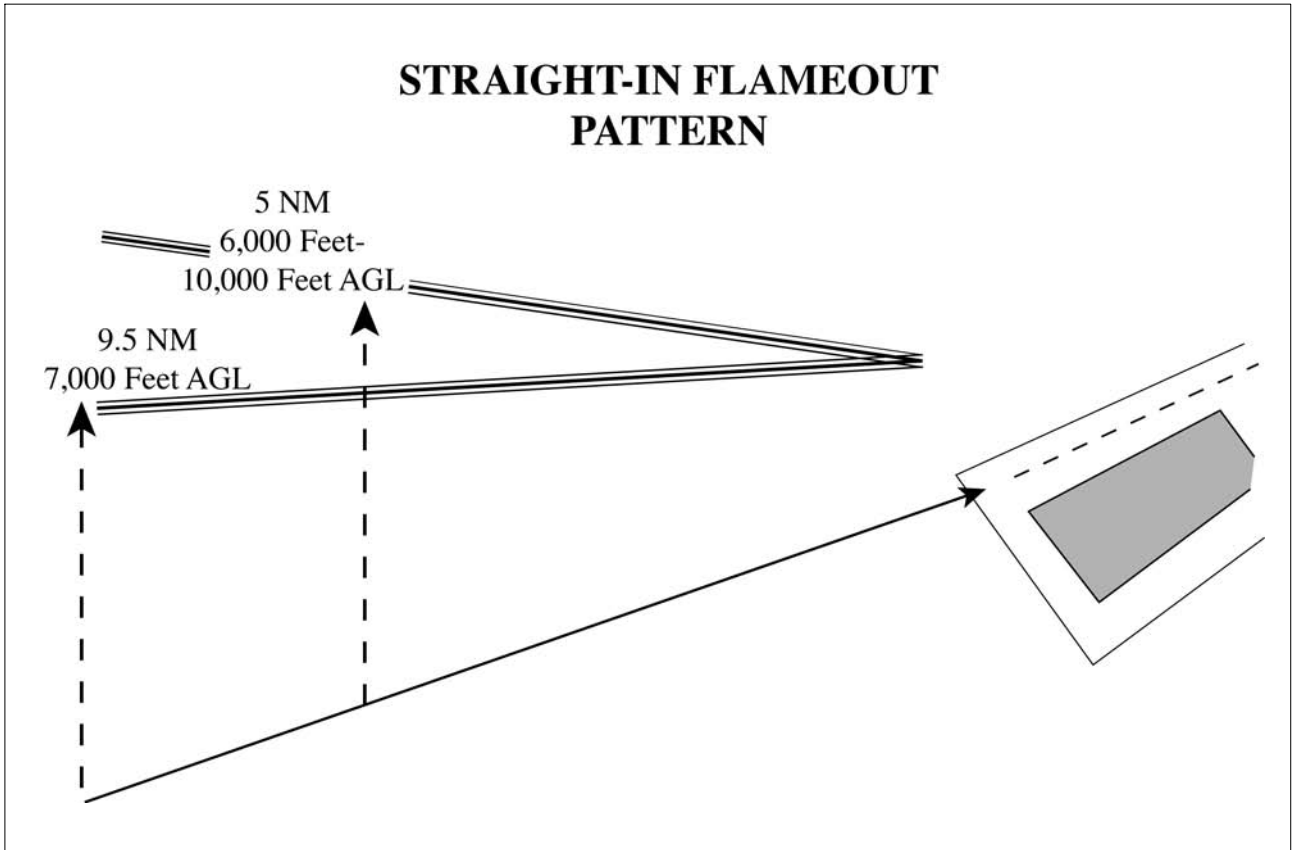
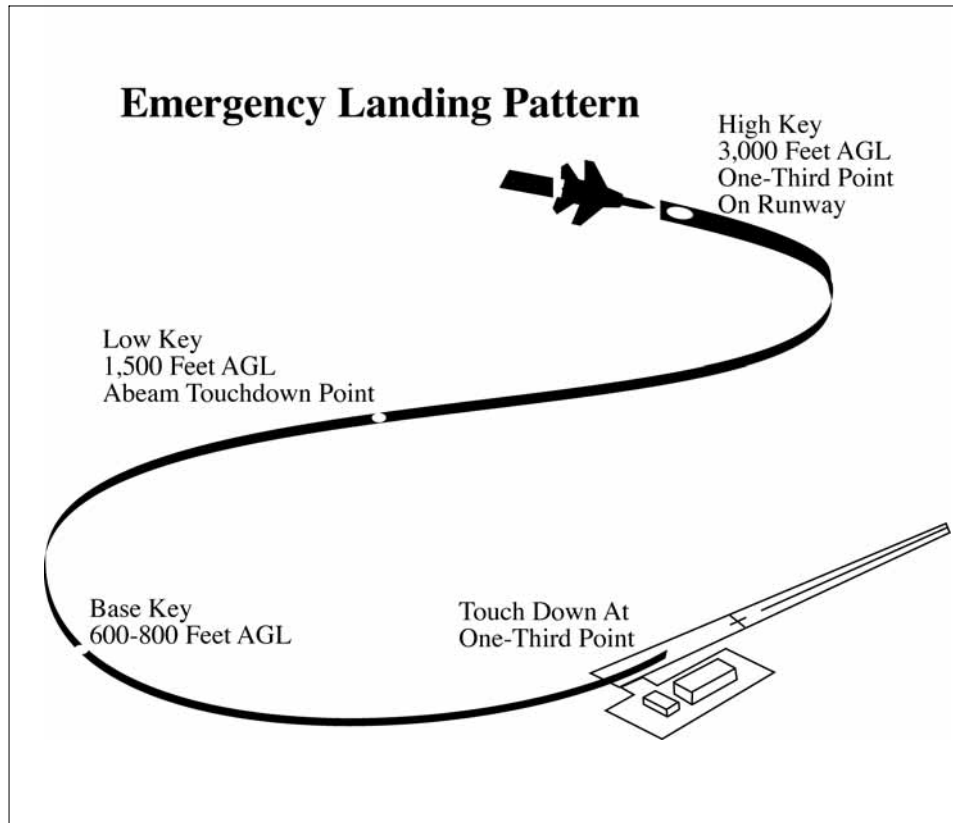

FIG 3-10-16
Emergency Landing Pattern



Section 11. Helicopter Operations

3-11-1. TAXI AND GROUND MOVEMENT OPERATION

a. When necessary for a wheeled helicopter to taxi on the surface, use the phraseology in para 3-7-2, Taxi and Ground Movement Operations.

NOTE-

Ground taxiing uses less fuel than hover-taxiing and minimizes air turbulence. However, under certain conditions, such as rough, soft, or uneven terrain, it may become necessary to hover/air-taxi for safety considerations. Helicopters with articulating rotors (usually designs with three or more main rotor blades) are subject to "ground resonance" and may, on rare occasions, suddenly lift off the ground to avoid severe damage or destruction.

b. When requested or necessary for a helicopter/VTOL aircraft to proceed at a slow speed above the surface, normally below 20 knots and in ground effect, use the following phraseology, supplemented as appropriate with the phraseology in para 3-7-2, Taxi and Ground Movement Operations.

PHRASEOLOGY-

HOVER-TAXI (supplemented, as appropriate, from para 3-7-2 Taxi and Ground Movement Operations.)

CAUTION (dust, blowing snow, loose debris, taxiing light aircraft, personnel, etc.).

NOTE-

Hover-taxiing consumes fuel at a high burn rate, and helicopter downwash turbulence (produced in ground effect) increases significantly with larger and heavier helicopters.

REFERENCE-

P/CG Term- Hover Taxi.

AIM, VFR Helicopter Operations at Controlled Airports, Para 4-3-17.

c. When requested or necessary for a helicopter to proceed expeditiously from one point to another, normally below 100 feet AGL and at airspeeds above 20 knots, use the following phraseology, supplemented as appropriate with the phraseology in para 3-7-2, Taxi and Ground Movement Operations.

PHRASEOLOGY-

AIR-TAXI:

VIA (direct, as requested, or specified route)

TO (location, heliport, helipad, operating/movement area, active/inactive runway).

*AVOID (aircraft/vehicles/personnel).
If required,*

REMAIN AT OR BELOW (altitude).

CAUTION (wake turbulence or other reasons above).

LAND AND CONTACT TOWER,

or

HOLD FOR (reason- takeoff clearance, release, landing/taxiing aircraft, etc.).

NOTE-

Air-taxi is the preferred method for helicopter movements on airports provided ground operations/conditions permit. Air-taxi authorizes the pilot to proceed above the surface either via hover-taxi or flight at speeds more than 20 knots. Unless otherwise requested or instructed, the pilot is expected to remain below 100 feet AGL. The pilot is solely responsible for selecting a safe airspeed for the altitude/operation being conducted.

REFERENCE-

P/CG Term- Air Taxi.

AIM, VFR Helicopter Operations at Controlled Airports, Para 4-3-17.

WAKE TURBULENCE APPLICATION

d. Avoid clearances which require small aircraft or helicopters to taxi in close proximity to taxiing or hover-taxi helicopters.

REFERENCE-

AC 90-23, Aircraft Wake Turbulence, Para 10 and Para 11.

3-11-2. HELICOPTER TAKEOFF CLEARANCE

a. Issue takeoff clearance from movement areas other than active runways, or in diverse directions from active runways, with additional instructions, as necessary. Whenever possible, issue takeoff clearance in lieu of extended hover-taxi or air-taxi operations.

PHRASEOLOGY–

(Present position, taxiway, helipad, numbers) **MAKE RIGHT/LEFT TURN FOR** (direction, points of compass, heading, NAVAID radial) **DEPARTURE/DEPARTURE ROUTE** (number, name, or code), **AVOID** (aircraft/vehicles/personnel),

or

REMAIN (direction) **OF** (active runways, parking areas, passenger terminals, etc.).

CAUTION (power lines, unlighted obstructions, trees, wake turbulence, etc.).

CLEARED FOR TAKEOFF.

b. If takeoff is requested from nonmovement areas and, in your judgment, the operation appears to be reasonable, use the following phraseology instead of the takeoff clearance in subpara a.

PHRASEOLOGY–

PROCEED AS REQUESTED, USE CAUTION (reason and additional instructions, as appropriate).

c. If takeoff is requested from an area not visible, an area not authorized for helicopter use, an unlighted nonmovement area at night, or an area off the airport, and traffic is not a factor, use the following phraseology.

PHRASEOLOGY–

DEPARTURE FROM (requested location) **WILL BE AT YOUR OWN RISK** (reason and additional instructions, as necessary).

d. Unless requested by the pilot, do not issue downwind takeoffs if the tailwind exceeds 5 knots.

NOTE–

A pilot request to takeoff from a given point in a given direction constitutes such a request.

3-11-3. HELICOPTER DEPARTURE SEPARATION

Separate a departing helicopter from other helicopters by ensuring that it does not takeoff until one of the following conditions exists:

NOTE–

Helicopters performing air-taxiing operations within the boundary of the airport are considered to be taxiing aircraft.

a. A preceding, departing helicopter has left the takeoff area. (See FIG 3-11-1.)

FIG 3-11-1

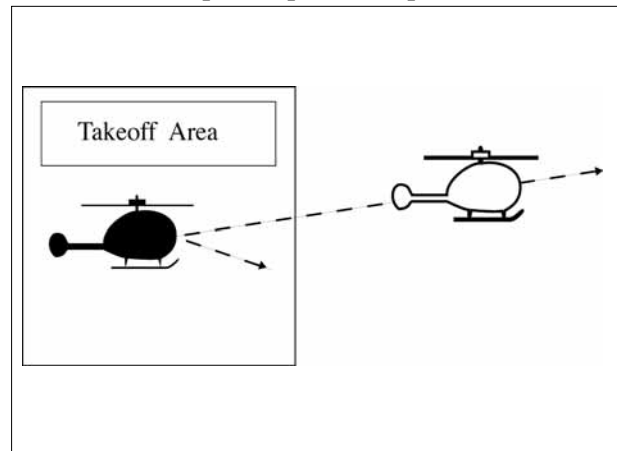
Helicopter Departure Separation

b. A preceding, arriving helicopter has taxied off the landing area. (See FIG 3-11-2.)

FIG 3-11-2

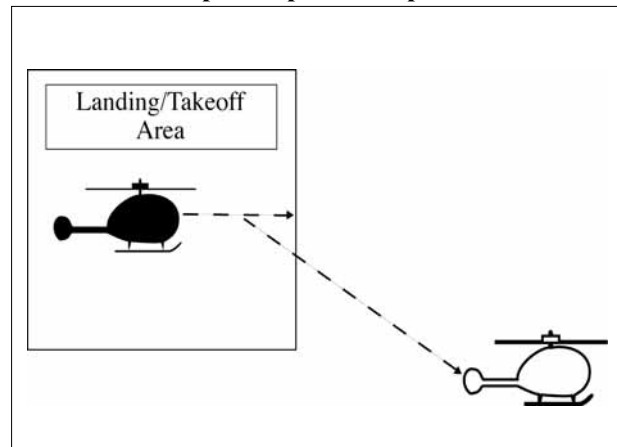
Helicopter Departure Separation

3-11-4. HELICOPTER ARRIVAL SEPARATION

Separate an arriving helicopter from other helicopters by ensuring that it does not land until one of the following conditions exists:

- a. A preceding, arriving helicopter has come to a stop or taxied off the landing area.
(See FIG 3-11-3 and FIG 3-11-4.)

FIG 3-11-3

Helicopter Arrival Separation

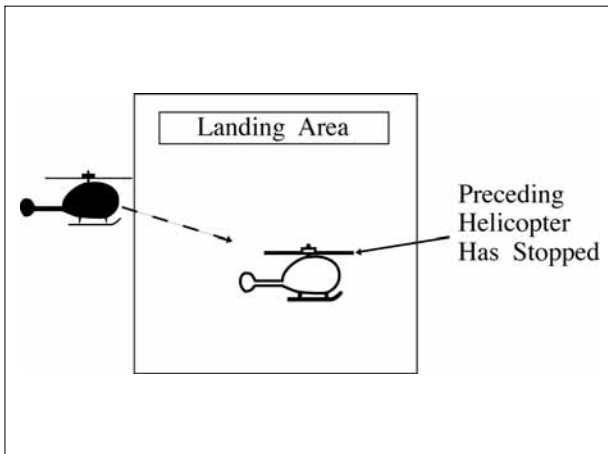
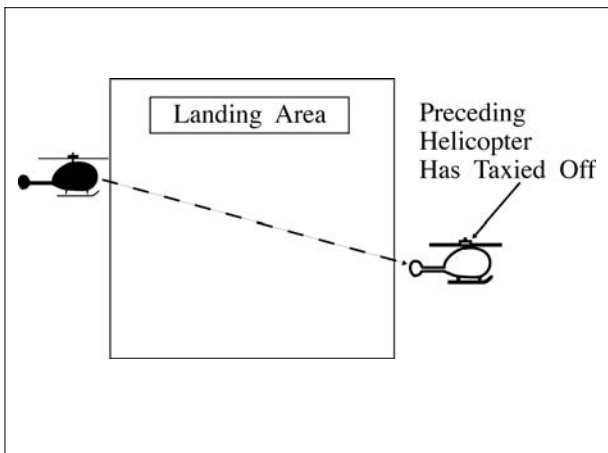

FIG 3-11-4

Helicopter Arrival Separation



- b. A preceding, departing helicopter has left the landing area. (See FIG 3-11-5.)

FIG 3-11-5

Helicopter Arrival Separation

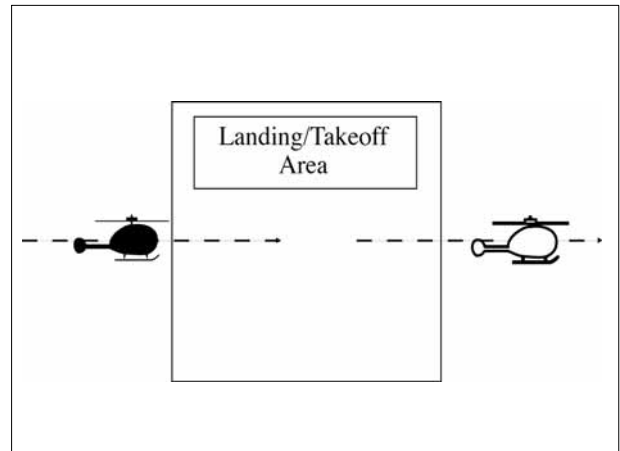

3-11-5. SIMULTANEOUS LANDINGS OR TAKEOFFS

Authorize helicopters to conduct simultaneous landings or takeoffs if the distance between the landing or takeoff points is at least 200 feet and the courses to be flown do not conflict. Refer to surface markings to determine the 200 foot minimum, or instruct a helicopter to remain at least 200 feet from another helicopter. (See FIG 3-11-6.)

FIG 3-11-6

Simultaneous Helicopter Landings or Takeoffs

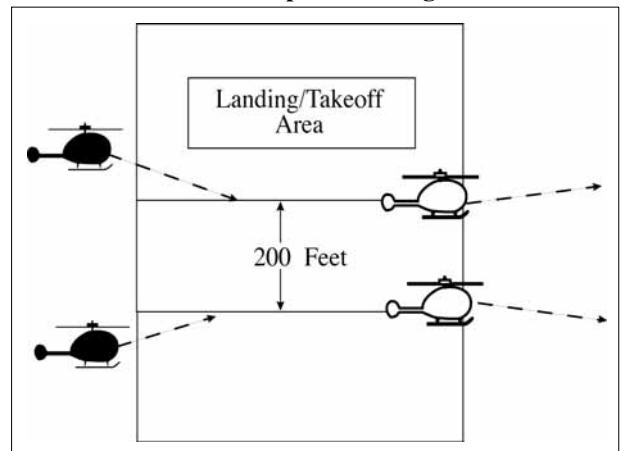

3-11-6. HELICOPTER LANDING CLEARANCE

a. Issue landing clearance for helicopters to movement areas other than active runways, or from diverse directions to points on active runways, with additional instructions, as necessary. Whenever possible, issue landing clearance in lieu of extended hover-taxi or air-taxi operations.

PHRASEOLOGY-

MAKE APPROACH STRAIGHT-IN/CIRCLING LEFT/RIGHT TURN TO (location, runway, taxiway, helipad, Maltese cross) ARRIVAL/ARRIVAL ROUTE (number, name, or code).

HOLD SHORT OF (active runway, extended runway centerline, other).

REMAIN (direction/distance; e.g., 700 feet, 1 1/2 miles) FROM (runway, runway centerline, other helicopter/aircraft).

CAUTION (power lines, unlighted obstructions, wake turbulence, etc.).

CLEARED TO LAND.

CONTACT GROUND.

AIR TAXI TO RAMP.

b. If landing is requested to nonmovement areas and, in your judgment, the operation appears to be reasonable, use the following phraseology instead of the landing clearance in subpara a above.

PHRASEOLOGY-

PROCEED AS REQUESTED, USE CAUTION (reason and additional instructions, as appropriate).

c. If landing is requested to an area not visible, an area not authorized for helicopter use, an unlighted nonmovement area at night, or an area off the airport, and traffic is not a factor, use the following phraseology.

PHRASEOLOGY-

LANDING AT (requested location) WILL BE AT YOUR OWN RISK (reason and additional instructions, as necessary).

TRAFFIC (as applicable),

or

TRAFFIC NOT A FACTOR.

d. Unless requested by the pilot, do not issue downwind landings if the tailwind exceeds 5 knots.

NOTE-

A pilot request to land at a given point from a given direction constitutes such a request.

Section 12. Sea Lane Operations

3-12-1. APPLICATION

Where sea lanes are established and controlled, apply the provisions of this section.

3-12-2. DEPARTURE SEPARATION

Separate a departing aircraft from a preceding departing or arriving aircraft using the same sea lane by ensuring that it does not commence takeoff until:

a. The other aircraft has departed and crossed the end of the sea lane or turned to avert any conflict. (See FIG 3-12-1). If you can determine distances by reference to suitable landmarks, the other aircraft need only be airborne if the following minimum distance exists between aircraft:

1. When only Category I aircraft are involved- 1,500 feet.
2. When a Category I aircraft is preceded by a Category II aircraft- 3,000 feet.
3. When either the succeeding or both are Category II aircraft- 3,000 feet.
4. When either is a Category III aircraft- 6,000 feet. (See FIG 3-12-2.)

FIG 3-12-1

Sea Lane Departure Operations

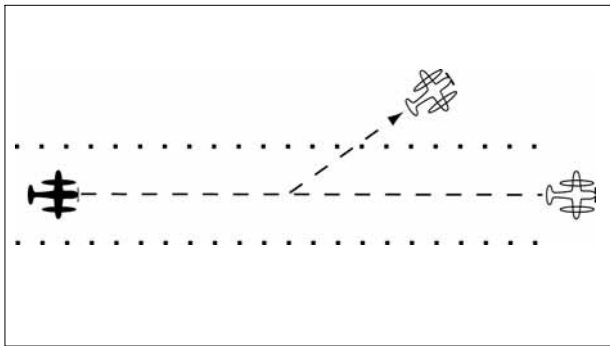
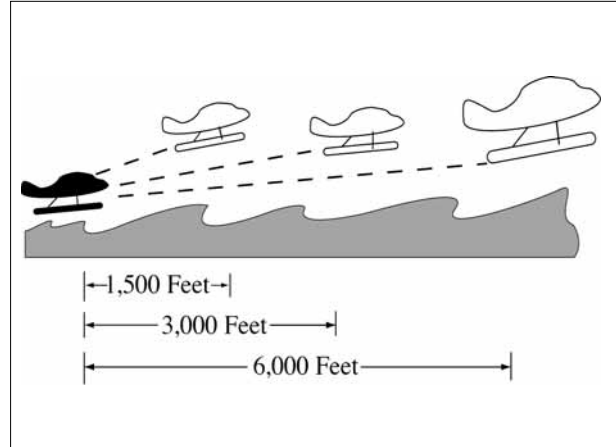

FIG 3-12-2

Sea Lane Departure Operations



b. A preceding landing aircraft has taxied out of the sea lane.

NOTE-

Due to the absence of braking capability, caution should be exercised when instructing a float plane to hold a position as the aircraft will continue to move because of prop generated thrust. Clearance to taxi into position and hold should, therefore, be followed by takeoff or other clearance as soon as practicable.

3-12-3. ARRIVAL SEPARATION

Separate an arriving aircraft from another aircraft using the same sea lane by ensuring that the arriving aircraft does not cross the landing threshold until one of the following conditions exists:

a. The other aircraft has landed and taxied out of the sea lane. Between sunrise and sunset, if you can determine distances by reference to suitable landmarks and the other aircraft has landed, it need not be clear of the sea lane if the following minimum distance from the landing threshold exists:

1. When a Category I aircraft is landing behind a Category I or II— 2,000 feet. (See FIG 3-12-3.)

FIG 3-12-3
Sea Lane Arrival Operations

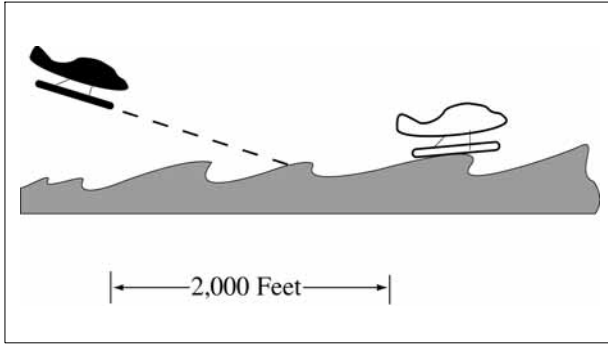

2. When a Category II aircraft is landing behind a Category I or II— 2,500 feet. (See FIG 3-12-4.)

FIG 3-12-4
Sea Lane Arrival Operations
[View 2]

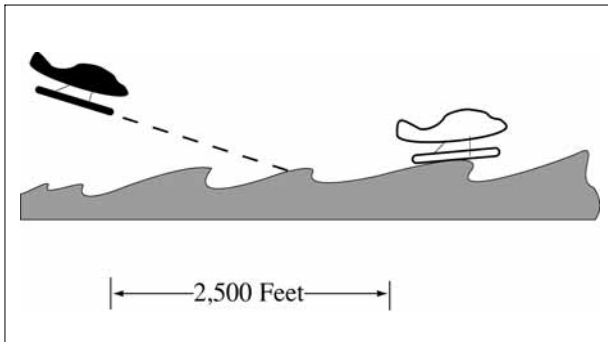

b. The other aircraft has departed and crossed the end of the sea lane or turned to avert any conflict. (See FIG 3-12-5.) If you can determine distances by reference to suitable landmarks and the other aircraft is airborne, it need not have crossed the end of the sea

lane if the following minimum distance from the landing threshold exists:

1. When only Category I aircraft are involved— 1,500 feet.
2. When either is a Category II aircraft— 3,000 feet.
3. When either is a Category III aircraft— 6,000 feet. (See FIG 3-12-6.)

FIG 3-12-5
Sea Lane Arrival Operations

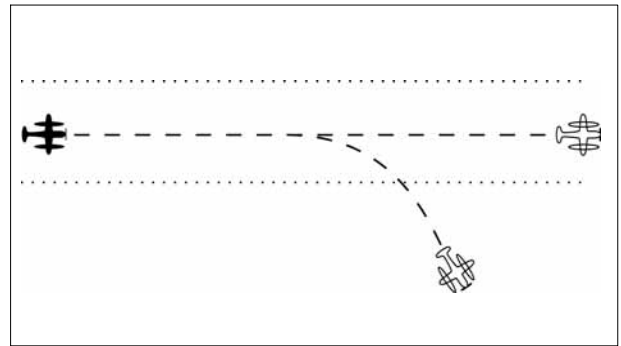
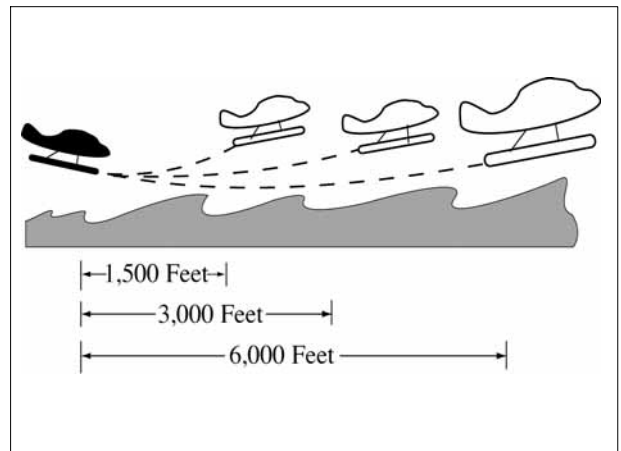

FIG 3-12-6
Sea Lane Arrival Operations



Chapter 4. IFR

Section 1. NAVAID Use Limitations

4-1-1. ALTITUDE AND DISTANCE LIMITATIONS

When specifying a route other than an established airway or route, do not exceed the limitations in the table on any portion of the route which lies within controlled airspace. (For altitude and distance limitations, see TBL 4-1-1, TBL 4-1-2, TBL 4-1-3, and TBL 4-1-4.) (For correct application of altitude and distance limitations see FIG 4-1-1 and FIG 4-1-2.)

REFERENCE-

FAAO 7110.65, Fix Use, Para 4-1-5
 FAAO 7110.65, Methods, Para 5-6-2

TBL 4-1-1

VOR/VORTAC/TACAN NAVAIDS
 Normal Usable Altitudes and Radius Distances

Class	Altitude	Distance (miles)
T	12,000 and below	25
L	Below 18,000	40
H	Below 14,500	40
H	14,500 – 17,999	100
H	18,000 – FL 450	130
H	Above FL 450	100

TBL 4-1-2

L/MF Radio Beacon (RBN)
 Usable Radius Distances for All Altitudes

Class	Power (watts)	Distance (miles)
CL	Under 25	15
MH	Under 50	25
H	50 – 1,999	50
HH	2,000 or more	75

TBL 4-1-3

ILS
 Usable Height and Distance*

Height (feet) above transmitter	Distance (miles from transmitter)
4,500	10 (for glideslope)
4,500	18 (for localizer)

*Use the current flight check height/altitude limitations if different from the above minima.

TBL 4-1-4

MLS
 Usable Height and Distance*

Height (feet) above transmitter	Distance (miles from transmitter)
20,000	20 (for glideslope)
20,000	20 (for azimuth)

*Use the current flight check height/altitude limitations if different from the above minima.

FIG 4-1-1

Application of Altitude and Distance Limitations [Application 1]

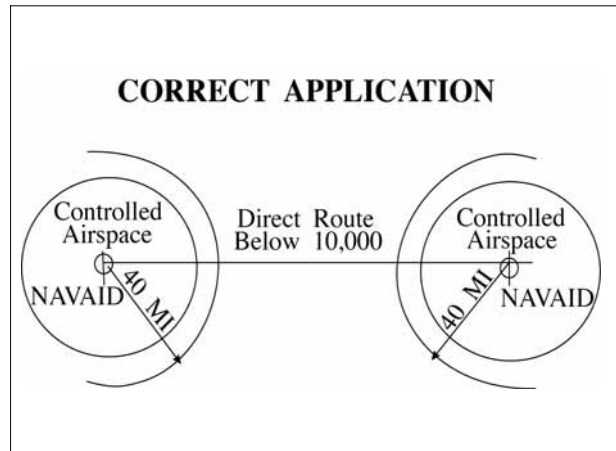
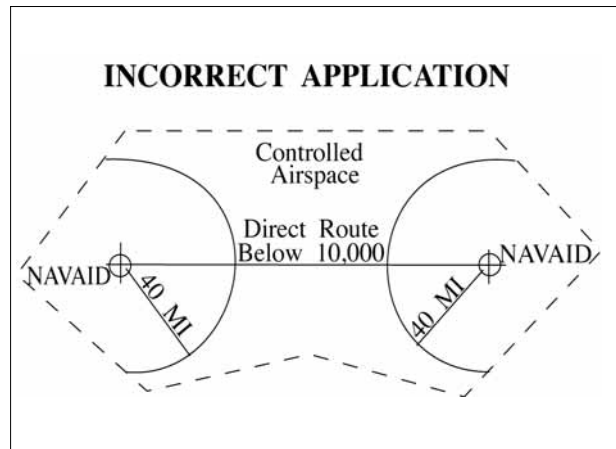

FIG 4-1-2

Application of Altitude and Distance Limitations [Application 2]



4-1-2. EXCEPTIONS

Altitude and distance limitations need not be applied when any of the following conditions are met:

a. Routing is initiated by ATC or requested by the pilot and the following is provided:

1. Radar monitoring.

2. As necessary, course guidance unless the aircraft is /E, /F, /G, or /R equipped.

NOTE-

1. *Para 5-5-1 Application, requires radar separation be provided to RNAV aircraft on random (impromptu) routes at FL 450 and below.*

2. *When a clearance is issued beyond the altitude and/or distance limitations of a NAVAID, in addition to being responsible for maintaining separation from other aircraft and airspace, the controller is responsible for providing aircraft with information and advice related to significant deviations from the expected flight path.*

REFERENCE-

P/CG Term- Radar Monitoring.

b. Operational necessity requires and approval has been obtained from the Frequency Management and Flight Inspection Offices to exceed them.

c. Requested routing is via an MTR.

REFERENCE-

FAAO 7110.65, Methods, Para 5-6-2

4-1-3. CROSSING ALTITUDE

Use an altitude consistent with the limitations of the aid when clearing an aircraft to cross or hold at a fix.

REFERENCE-

FAAO 7110.65, Methods, Para 5-6-2

4-1-4. VFR-ON-TOP

Use a route not meeting service volume limitations only if an aircraft requests to operate "VFR-on-top" on this route.

NOTE-

Aircraft equipped with TACAN only are expected to:

a. *Define route of flight between TACAN or VORTAC NAVAIDs in the same manner as VOR-equipped aircraft.*

b. *Except in Class A airspace, submit requests for "VFR-on-top" flight where insufficient TACAN or VORTAC NAVAIDs exist to define the route.*

REFERENCE-

FAAO 7110.65, Methods, Para 5-6-2

4-1-5. FIX USE

Request aircraft position reports only over fixes shown on charts used for the altitude being flown, except as follows:

NOTE-

Waypoints filed in random RNAV routes automatically become compulsory reporting points for the flight unless otherwise advised by ATC.

a. Unless the pilot requests otherwise, use only those fixes shown on high altitude en route charts, high altitude instrument approach procedures charts, and DP charts when clearing military turbojet single-piloted aircraft.

b. Except for military single-piloted turbojet aircraft, unpublished fixes may be used if the name of the NAVAID and, if appropriate, the radial/course/azimuth and frequency/channel are given to the pilot. An unpublished fix is defined as one approved and planned for publication which is not yet depicted on the charts or one which is used in accord with the following:

REFERENCE-

FAAO 7130.3, Holding Pattern Criteria.

1. Unpublished fixes are formed by the en route radial and either a DME distance from the same NAVAID or an intersecting radial from an off-route VOR/VORTAC/TACAN. DME shall be used in lieu of off-route radials, whenever possible.

2. Except where known signal coverage restrictions exist, an unpublished fix may be used for ATC purposes if its location does not exceed NAVAID altitude and distance limitation, and when off-route radials are used, the angle of divergence meets the criteria prescribed below.

NOTE-

Unpublished fixes should not negate the normal use of published intersections. Frequent routine use of an unpublished fix would justify establishing a fix.

REFERENCE-

FAAO 7110.65, Altitude and Distance Limitations, Para 4-1-1

3. Do not hold aircraft at unpublished fixes below the lowest assignable altitude dictated by terrain clearance for the appropriate holding pattern airspace area (template) regardless of the MEA for the route being flown.

4. When the unpublished fix is located on an off-route radial and the radial providing course guidance, it shall be used consistent with the following divergence angles:

(a) When holding operations are involved with respect to subparas (b) and (c) below, the angle of divergence shall be at least 45 degrees.

(b) When both NAVAIDs involved are located within 30 NM of the unpublished fix, the minimum divergence angle is 30 degrees.

(c) When the unpublished fix is located over 30 NM from the NAVAID generating the off-course radial, the minimum divergence angle shall increase 1 degree per NM up to 45 NM; e.g., 45 NM would require 45 degrees.

(d) When the unpublished fix is located beyond 45 NM from the NAVAID generating the off-course radial, the minimum divergence angle

shall increase $\frac{1}{2}$ degree per NM; e.g., 130 NM would require 88 degrees.

c. Fixes contained in the route description of MTRs are considered filed fixes.

d. TACAN-only aircraft (type suffix M, N, or P) possess TACAN with DME, but no VOR or LF navigation system capability. Assign fixes based on TACAN or VORTAC facilities only.

NOTE-

TACAN-only aircraft can never be held overhead the NAVAID, be it TACAN or VORTAC.

e. DME fixes shall not be established within the no-course signal zone of the NAVAID from which inbound holding course information would be derived.

REFERENCE-

FAAO 7110.65, NAVAID Fixes, Para 2-5-3
FAAO 7110.65, Methods, Para 5-6-2

Section 2. Clearances

4-2-1. CLEARANCE ITEMS

Issue the following clearance items, as appropriate, in the order listed below:

- a. Aircraft identification.
- b. Clearance limit.
- c. Standard Instrument Departure (SID).
- d. Route of flight including PDR/PDAR/PAR when applied.
- e. Altitude data in the order flown.
- f. Mach number, if applicable.
- g. *USAF*. When issuing a clearance to an airborne aircraft containing an altitude assignment, do not include more than one of the following in the same transmission:
 - 1. Frequency change.
 - 2. Transponder change.
 - 3. Heading.
 - 4. Altimeter setting.
 - 5. Traffic information containing an altitude.

- h. Holding instructions.
- i. Any special information.
- j. Frequency and beacon code information.

REFERENCE-

FAAO 7110.65, *IFR-VFR and VFR-IFR Flights*, Para 4-2-8
FAAO 7110.65, *Altitude Information*, Para 4-5-7

4-2-2. CLEARANCE PREFIX

a. Prefix a clearance, information, or a request for information which will be relayed to an aircraft through a non-ATC facility by stating “A-T-C clears,” “A-T-C advises,” or “A-T-C requests.”

b. Flight service stations shall prefix a clearance with the appropriate phrase: “ATC clears,” “ATC advises,” etc.

4-2-3. DELIVERY INSTRUCTIONS

Issue specific clearance delivery instructions, if appropriate.

4-2-4. CLEARANCE RELAY

Relay clearances verbatim.

REFERENCE-

FAAO 7110.65, *Communications Failure*, Para 10-4-4

4-2-5. ROUTE OR ALTITUDE AMENDMENTS

a. Amend route of flight in a previously issued clearance by one of the following:

1. State which portion of the route is being amended and then state the amendment.

PHRASEOLOGY-

CHANGE (portion of route) TO READ (new portion of route).

2. State the amendment to the route and then state that the rest of the route is unchanged.

PHRASEOLOGY-

(Amendment to route), REST OF ROUTE UNCHANGED.

3. Issue a clearance “direct” to a point on the previously issued route.

PHRASEOLOGY-

CLEARED DIRECT (fix).

NOTE-

Clearances authorizing “direct” to a point on a previously issued route do not require the phrase “rest of route unchanged.” However, it must be understood where the previously cleared route is resumed. When necessary, “rest of route unchanged” may be used to clarify routing.

4. Issue the entire route by stating the amendment.

EXAMPLE-

(Cessna 21A has been cleared to the Airville Airport via V41 Delta VOR V174 Alfa VOR, direct Airville Airport, maintain 9000. After takeoff, the aircraft is rerouted via V41 Frank intersection, V71 Delta VOR, V174 Alfa VOR. The controller issues one of the following as an amended clearance):

1. *“Cessna Two One Alfa change Victor Forty-One Delta to read Victor Forty-One Frank, Victor Seventy-One Delta.”*

2. *“Cessna Two One Alfa cleared via Victor Forty-One Frank, Victor Seventy-One Delta, rest of route unchanged.”*

3. *“Cessna Two One Alfa cleared via Victor Forty-One Frank, Victor Seventy-One Delta, Victor One*

Seventy-Four Alfa V-O-R, direct Airville airport, maintain Niner Thousand.”

b. When route or altitude in a previously issued clearance is amended, restate all applicable altitude restrictions.

EXAMPLE-

(A departing aircraft is cleared to cross Ollis intersection at or above 3,000; Gordonsville VOR at or above 12,000; maintain FL 200. Shortly after departure the altitude to be maintained is changed to FL 240. Because altitude restrictions remain in effect, the controller issues an amended clearance as follows):

“Amend altitude. Cross Ollis intersection at or above Three Thousand; cross Gordonsville V-O-R at or above One Two Thousand; maintain Flight Level Two Four Zero.”

(Shortly after departure, altitude restrictions are no longer applicable, the controller issues an amended clearance as follows):

“Climb and maintain Flight Level Two Four Zero.”

NOTE-

Restating previously issued altitude to “maintain” is an amended clearance. If altitude to “maintain” is changed or restated, whether prior to departure or while airborne, and previously issued altitude restrictions are omitted, altitude restrictions are canceled, including DP/FMSP/STAR altitude restrictions if any.

c. Issue an amended clearance if a speed restriction is declined because it cannot be complied with concurrently with a previously issued altitude restriction.

EXAMPLE-

(An aircraft is cleared to cross Gordonsville VOR at 11,000. Shortly thereafter he/she is cleared to reduce his/her airspeed to 300 knots. The pilot informs the controller he/she is unable to comply with both clearances simultaneously. The controller issues an amended clearance as follows):

“Cross Gordonsville VOR at One One Thousand. Then, reduce speed to Three Zero Zero.”

NOTE-

The phrase “do the best you can” or comparable phrases are not valid substitutes for an amended clearance with altitude or speed restrictions.

REFERENCE-

*FAAO 7110.65, Operational Requests, Para 2-1-18
FAAO 7110.65, Section 6, Vectoring, Methods, Para 5-6-2
FAAO 7110.65, Section 7, Speed Adjustment, Methods, Para 5-7-2*

d. Air traffic control specialists should avoid route and/or altitude changes for aircraft participating in the North American Route Program (NRP) and that are displaying “NRP” in the remarks section of their flight plan. Specialists at facilities actively participating in the High Altitude Redesign (HAR) program should avoid route and/or altitude changes for aircraft participating in full HAR and high altitude Point-to-point (PTP), and that are displaying “HAR,” or “PTP” in the remarks section of their flight plan.

NOTE-

Air traffic control specialists retain the latitude necessary to tactically resolve conflicts. Every effort should be made to ensure the aircraft is returned to the original filed flight plan/altitude as soon as conditions warrant.

REFERENCE-

*FAAO 7110.65, Operational Priority, Para 2-1-4
FAAO 7110.65, North American Route Program (NRP) Information, Para 2-2-15
FAAO 7110.65, En Route Data Entries, Para 2-3-2
FAAO 7210.3, Chapter 17, Section 14, North American Route Program.* ■

4-2-6. THROUGH CLEARANCES

You may clear an aircraft through intermediate stops.

PHRASEOLOGY-

CLEARED THROUGH (airport) TO (fix).

4-2-7. ALTRV CLEARANCE

Use the phrase “via approved altitude reservation flight plan,” if the aircraft will operate in an approved ALTRV.

PHRASEOLOGY-

VIA APPROVED ALTITUDE RESERVATION (mission name) FLIGHT PLAN.

NOTE-

An ALTRV normally includes the departure, climb, cruise, and arrival phases of flight up to and including holding pattern or point/time at which ATC provides separation between aircraft.

REFERENCE-

FAAO 7110.65, Abbreviated Departure Clearance, Para 4-3-3

4-2-8. IFR-VFR AND VFR-IFR FLIGHTS

a. Clear an aircraft planning IFR operations for the initial part of flight and VFR for the latter part to the fix at which the IFR part ends.

b. Treat an aircraft planning VFR for the initial part of flight and IFR for the latter part as a VFR departure. Issue a clearance to this aircraft when it requests IFR clearance approaching the fix where it proposes to start IFR operations. The phraseology CLEARED TO (destination) AIRPORT AS FILED may be used with abbreviated departure clearance procedures.

REFERENCE-

FAAO 7110.65, *Abbreviated Departure Clearance, Para 4-3-3*

c. When an aircraft changes from VFR to IFR, the controller shall assign a beacon code to Mode-C equipped aircraft that will allow MSAW alarms.

d. When a VFR aircraft, operating below the minimum altitude for IFR operations, requests an IFR clearance and you are aware that the pilot is unable to climb in VFR conditions to the minimum IFR altitude:

1. Before issuing a clearance, ask if the pilot is able to maintain terrain and obstruction clearance during a climb to the minimum IFR altitude.

NOTE-

Pilots of pop-up aircraft are responsible for terrain and obstacle clearance until reaching minimum instrument altitude (MIA) or minimum en route altitude (MEA). Pilot compliance with an approved FAA procedure or an ATC instruction transfers that responsibility to the FAA; therefore, do not assign (or imply) specific course guidance that will (or could) be in effect below the MIA or MEA.

EXAMPLE-

“November Eight Seven Six, are you able to provide your own terrain and obstruction clearance between your present altitude and six thousand feet?”

2. If the pilot is able to maintain terrain and obstruction separation, issue the appropriate clearance as prescribed in para 4-2-1, Clearance Items, and para 4-5-6, Minimum En Route Altitudes.

3. If unable to maintain terrain and obstruction separation, instruct the pilot to maintain VFR and to state intentions.

4. If appropriate, apply the provisions of para 10-2-7, VFR Aircraft In Weather Difficulty, or para 10-2-9, Radar Assistance Techniques, as necessary.

4-2-9. CLEARANCE ITEMS

The following guidelines shall be utilized to facilitate the processing of airfile aircraft:

a. Ensure the aircraft is within your area of jurisdiction unless otherwise coordinated.

b. Obtain necessary information needed to provide IFR service.

c. Issue clearance to destination, short range clearance, or an instruction to the pilot to contact a FSS or AFSS if the flight plan cannot be processed.

NOTE-

These procedures do not imply that the processing of airfiles has priority over another ATC duty to be performed.

REFERENCE-

FAAO 7110.65, *Recording Information, Para 2-2-1*

Section 3. Departure Procedures

4-3-1. DEPARTURE TERMINOLOGY

Avoid using the term “takeoff” except to actually clear an aircraft for takeoff or to cancel a takeoff clearance. Use such terms as “depart,” “departure,” or “fly” in clearances when necessary.

REFERENCE-

FAAO 7110.65, *Takeoff Clearance, Para 3-9-9*

FAAO 7110.65, *Cancellation of Takeoff Clearance, Para 3-9-10*

4-3-2. DEPARTURE CLEARANCES

Include the following items in IFR departure clearances:

NOTE-

When considered necessary, controllers or pilots may initiate read backs of a clearance. Some pilots may be required by company rule to do so.

a. Always include the airport of departure when issuing a departure clearance for relay to an aircraft by an FSS, dispatcher, etc.

b. Clearance Limit.

1. Specify the destination airport when practicable, even though it is outside controlled airspace. Issue short range clearances as provided for in any procedures established for their use.

2. For Air Force One (A1) operations, do not specify the destination airport.

NOTE-

Presidential detail is responsible for ensuring the accuracy of the destination airport.

PHRASEOLOGY-

DESTINATION AS FILED.

c. Departure Procedures.

1. Specify direction of takeoff/turn or initial heading/azimuth to be flown after takeoff as follows:

(a) Locations with Airport Traffic Control Service– Specify these items as necessary.

(b) Locations without Airport Traffic Control Service, but within a Class E surface area– specify these items if necessary. Obtain/solicit the pilot’s concurrence concerning these items before issuing them in a clearance.

NOTE-

Direction of takeoff and turn after takeoff can be obtained/solicited directly from the pilot, or relayed by an FSS, dispatcher, etc., as obtained/solicited from the pilot.

(c) At all other airports– Do not specify direction of takeoff/turn after takeoff. If necessary to specify an initial heading/azimuth to be flown after takeoff, issue the initial heading/azimuth so as to apply only within controlled airspace.

2. Where only textually described instrument departure procedures have been published for a location and pilot compliance is necessary to insure separation, include the procedure as part of the ATC clearance.

EXAMPLE-

“Depart via the (airport name) (runway number) departure procedure.”

NOTE-

IFR takeoff minimums and departure procedures are prescribed for specific airports/runways and published in a tabular form supplement to the FAA instrument approach procedure chart and appropriate FAA Form 8260. These procedures are identified on instrument approach procedure charts with a symbol:



3. Compatibility with a procedure issued may be verified by asking the pilot if items obtained/solicited will allow him/her to comply with local traffic pattern, terrain, or obstruction avoidance.

PHRASEOLOGY-

FLY RUNWAY HEADING.

DEPART (direction or runway).

TURN LEFT/RIGHT.

WHEN ENTERING CONTROLLED AIRSPACE (instruction), FLY HEADING (degrees) UNTIL REACHING (altitude, point, or fix) BEFORE PROCEEDING ON COURSE.

FLY A (degree) BEARING/AZIMUTH FROM/TO (fix) UNTIL (time),

or

UNTIL REACHING (fix or altitude),

and if required,

BEFORE PROCEEDING ON COURSE.

EXAMPLE–

“Verify right turn after departure will allow compliance with local traffic pattern,” or “Verify this clearance will allow compliance with terrain or obstruction avoidance.”

NOTE–

If a published IFR departure procedure is not included in an ATC clearance, compliance with such a procedure is the pilot’s prerogative.

4. SIDs:

(a) Assign a SID (including transition if necessary). Assign a PDR or the route filed by the pilot, only when a SID is not established for the departure route to be flown, or the pilot has indicated that he/she does not wish to use a SID.

PHRASEOLOGY–

(SID name and number) DEPARTURE.

(SID name and number) DEPARTURE,
(transition name) TRANSITION.

EXAMPLE–

“Stroudsburg One Departure.”
“Stroudsburg One Departure, Sparta Transition.”
“Stroudsburg One RNAV Departure.”

NOTE–

If a pilot does not wish to use a SID issued in an ATC clearance, or any other SID published for that location, he/she is expected to advise ATC.

(b) If it is necessary to assign a crossing altitude which differs from the SID altitude, repeat the changed altitude to the pilot for emphasis.

PHRASEOLOGY–

(SID name) DEPARTURE, EXCEPT (revised altitude information). I SAY AGAIN (revised altitude information).

EXAMPLE–

“Stroudsburg One Departure, except cross Quaker at five thousand. I say again, cross Quaker at five thousand.”

“Astoria Two RNAV Departure, except cross Astor waypoint at six thousand. I say again, cross Astor waypoint at six thousand.”

(c) Specify altitudes when they are not included in the SID.

PHRASEOLOGY–

(SID name) DEPARTURE. CROSS (fix) AT (altitude).

EXAMPLE–

“Stroudsburg One Departure. Cross Jersey intersection at four thousand. Cross Range intersection at six thousand.”

“Engle Two RNAV departure. Cross Pilim waypoint at or above five thousand. Cross Engle waypoint at or above seven thousand. Cross Gorge waypoint at niner thousand.”

d. Route of flight. Specify one or more of the following:

1. Airway, route, course, heading, azimuth, arc, or vector.

2. The routing a pilot can expect if any part of the route beyond a short range clearance limit differs from that filed.

PHRASEOLOGY–

EXPECT FURTHER CLEARANCE VIA (airways, routes, or fixes.)

e. Altitude. Use one of the following in the order of preference listed:

NOTE–

Turbojet aircraft equipped with afterburner engines may occasionally be expected to use afterburning during their climb to the en route altitude. When so advised by the pilot, the controller may be able to plan his/her traffic to accommodate the high performance climb and allow the pilot to climb to his/her planned altitude without restriction.

1. To the maximum extent possible, Air Force One will be cleared unrestricted climb to:

(a) 9,000’ AGL or higher.

(b) If unable 9,000’ AGL or higher, then the highest available altitude below 9,000’ AGL.

2. Assign the altitude requested by the pilot.

3. Assign an altitude, as near as possible to the altitude requested by the pilot, and

(a) Inform the pilot when to expect clearance to the requested altitude unless instructions are contained in the specified DP, or

(b) If the requested altitude is not expected to be available, inform the pilot what altitude can be expected and when/where to expect it.

NOTE–

1. 14 CFR Section 91.185, says that in the event of a two-way radio communication failure, in VFR conditions or if VFR conditions are encountered after the failure, the pilot shall continue the flight under VFR and land as soon as practicable. That section also says that when the failure occurs in IFR conditions the pilot shall continue flight at

the highest of the following altitudes or flight levels for the route segment being flown:

a. The altitude or flight level assigned in the last ATC clearance received.

b. The minimum altitude (converted, if appropriate, to minimum flight level as prescribed in 14 CFR Section 91.121(c)) for IFR operations. (This altitude should be consistent with MEAs, MOCAs, etc.)

c. The altitude or flight level ATC has advised may be expected in a further clearance.

2. If the expected altitude is the highest of the preceding choices, the pilot should begin to climb to that expected altitude at the time or fix specified in the clearance. The choice to climb to the expected altitude is not applicable if the pilot has proceeded beyond the specified fix or if the time designated in the clearance has expired.

PHRASEOLOGY—

CLIMB AND MAINTAIN (the altitude as near as possible to the pilot's requested altitude). **EXPECT** (the requested altitude or an altitude different from the requested altitude) **AT** (time or fix),

and if applicable,

(pilot's requested altitude) **IS NOT AVAILABLE**.

EXAMPLE—

1. A pilot has requested flight level 350. Flight level 230 is immediately available and flight level 350 will be available at the Appleton zero five zero radial 35 mile fix. The clearance will read:

"Climb and maintain flight level two three zero. Expect flight level three five zero at Appleton zero five zero radial three five mile fix."

2. A pilot has requested 9,000 feet. An altitude restriction is required because of facility procedures or requirements. Assign the altitude and advise the pilot at what fix/time the pilot may expect the requested altitude. The clearance could read:

"Climb and maintain five thousand. Expect niner thousand one zero minutes after departure."

3. A pilot has requested 17,000 feet which is unavailable. You plan 15,000 feet to be the pilot's highest altitude prior to descent to the pilot's destination but only 13,000 feet is available until San Jose VOR. Advise the pilot of the expected altitude change and at what fix/time to expect clearance to 15,000 feet. The clearance will read:

"Climb and maintain one three thousand. Expect one five thousand at San Jose. One seven thousand is not available."

REFERENCE—

FAAO 7110.65, *Abbreviated Departure Clearance, Para 4-3-3*
FAAO 7110.65, *Initial Heading, Para 5-8-2*

4-3-3. ABBREVIATED DEPARTURE CLEARANCE

a. Issue an abbreviated departure clearance if its use reduces verbiage and the following conditions are met:

REFERENCE—

FAAO 7110.65, *IFR-VFR and VFR-IFR Flights, Para 4-2-8*

1. The route of flight filed with ATC has not been changed by the pilot, company, operations officer, input operator, or in the stored flight plan program prior to departure.

NOTE—

A pilot will not accept an abbreviated clearance if the route of flight filed with ATC has been changed by him/her or the company or the operations officer before departure. He/she is expected to inform the control facility on initial radio contact if he/she cannot accept the clearance. It is the responsibility of the company or operations officer to inform the pilot when they make a change.

2. All ATC facilities concerned have sufficient route of flight information to exercise their control responsibilities.

NOTE—

The route of flight information to be provided may be covered in letters of agreement.

3. When the flight will depart IFR, destination airport information is relayed between the facilities concerned prior to departure.

EXAMPLE—

1. A tower or flight service station relay of destination airport information to the center when requesting clearance:

"Request clearance for United Four Sixty-One to O'Hare."

2. A center relay to the tower or flight service station when initiating a clearance:

"Clearance for United Four Sixty-One to O'Hare."

NOTE—

Pilots are expected to furnish the facility concerned with destination airport information on initial radio call-up. This will provide the information necessary for detecting any destination airport differences on facility relay.

4. The assigned altitude, according to the provisions in para 4-3-2, Departure Clearances, subpara e, is stated in the clearance.

b. If it is necessary to modify a filed route of flight in order to achieve computer acceptance due, for example, to incorrect fix or airway identification, the contraction "FRC," meaning "Full Route Clearance

Necessary,” or “FRC/(fix),” will be added to the remarks. “FRC” or “FRC/(fix)” must always be the first item of intra-center remarks. When “FRC” or “FRC/(fix)” appears on a flight progress strip, the controller issuing the ATC clearance to the aircraft shall issue a full route clearance to the specified fix, or, if no fix is specified, for the entire route.

EXAMPLE–

“Cleared to Missoula International Airport, Chief Two Departure to Angley; direct Salina; then as filed; maintain one seven thousand.”

NOTE–

Changes, such as those made to conform with traffic flows and preferred routings, are only permitted to be made by the pilot (or his/her operations office) or the controller responsible for initiating the clearance to the aircraft.

c. Specify the destination airport in the clearance.

d. When no changes are required in the filed route, state the phrase: “Cleared to (destination) airport, (SID and SID transition, as appropriate); then, as filed.” If a SID is not assigned, follow with “As filed.” Specify the assigned altitude; and, if required, add any additional instructions or information.

PHRASEOLOGY–

CLEARED TO (destination) AIRPORT;

and as appropriate,

*(SID name and number) DEPARTURE,
THEN AS FILED.*

MAINTAIN (altitude); (additional instructions or information).

If a SID is not assigned,

*CLEARED TO (destination) AIRPORT AS FILED.
MAINTAIN (altitude);*

and if required,

(additional instructions or information).

EXAMPLE–

“Cleared to Reynolds Airport; David Two RNAV Departure, Kingham Transition; then, as filed. Maintain niner thousand. Expect flight level four one zero, one zero minutes after departure.”

“Cleared to Reynolds Airport as filed. Maintain niner thousand. Expect flight level four one zero, one zero minutes after departure.”

NOTE–

1. *SIDs are excluded from “cleared as filed” procedures.*

2. *If a pilot does not wish to accept an ATC clearance to fly a SID, he/she is expected to advise ATC or state “NO SID” in his/her flight plan remarks.*

e. When a filed route will require revisions, the controller responsible for initiating the clearance to the aircraft shall either:

1. Issue a FRC/FRC until a fix; or

2. If it reduces verbiage, state the phrase: “Cleared to (destination) airport, (SID and SID transition, as appropriate), then as filed, except . . .” Specify the necessary revision, then the assigned altitude; and if required, add any additional instructions or information. If a SID is not assigned, state: “Cleared to (destination) airport as filed, except . . .” Specify the necessary revision, the assigned altitude; and if required, add any additional instructions or information.

PHRASEOLOGY–

CLEARED TO (destination) AIRPORT;

and as appropriate,

(SID name and number) DEPARTURE,

(transition name) TRANSITION; THEN,

*AS FILED, EXCEPT CHANGE ROUTE TO READ
(amended route portion).*

MAINTAIN (altitude);

and if required,

(additional instructions or information).

If a SID is not assigned,

CLEARED TO (destination) AIRPORT AS FILED,

EXCEPT CHANGE ROUTE TO READ (amended route portion).

MAINTAIN (altitude);

and if required,

(additional instructions or information).

EXAMPLE-

“Cleared to Reynolds Airport; South Boston One Departure; then, as filed, except change route to read South Boston Victor Twenty Greensboro. Maintain eight thousand, report leaving four thousand.”

“Cleared to Reynolds Airport as filed, except change route to read South Boston Victor Twenty Greensboro. Maintain eight thousand, report leaving four thousand.”

“Cleared to Reynolds Airport via Victor Ninety-one Albany, then as filed. Maintain six thousand.”

f. In a nonradar environment specify one, two, or more fixes, as necessary, to identify the initial route of flight.

EXAMPLE-

The filed route of flight is from Hutchins V10 Emporia, thence V10N and V77 to St. Joseph. The clearance will read:

“Cleared to Watson Airport as filed via Emporia, maintain Seven Thousand.”

g. Do not apply these procedures when a pilot requests a detailed clearance or to military operations conducted within ALTRV, stereo routes, operations above FL 600, and other military operations requiring special handling.

NOTE-

Departure clearance procedures and phraseology for military operations within approved altitude reservations, military operations above FL 600, and other military operations requiring special handling are contained in separate procedures in this order or in a LOA, as appropriate.

REFERENCE-

FAAO 7110.65, ALTRV Clearance, Para 4-2-7

FAAO 7110.65, Military Operations Above FL 600, Para 9-3-13

4-3-4. DEPARTURE RESTRICTIONS, CLEARANCE VOID TIMES, HOLD FOR RELEASE, AND RELEASE TIMES

Assign departure restrictions, clearance void times, hold for release, or release times when necessary to separate departures from other traffic or to restrict or regulate the departure flow.

REFERENCE-

FAAO 7110.65, Overdue Aircraft, Para 10-3-1

FAAO 7110.65, Traffic Restrictions, Para 10-4-1

FAAO 7110.65, Traffic Resumption, Para 10-4-3

a. Clearance Void Times.

1. When issuing clearance void times at airports not served by control towers, provide alternative

instructions requiring the pilots to advise ATC of their intentions no later than 30 minutes after the clearance void time if not airborne.

2. The facility delivering a clearance void time to a pilot shall issue a time check.

PHRASEOLOGY-

CLEARANCE VOID IF NOT OFF BY (clearance void time),

and if required,

IF NOT OFF BY (clearance void time), ADVISE (facility) NOT LATER THAN (time) OF INTENTIONS.

TIME (time in hours, minutes, and the nearest quarter minute).

b. Hold For Release (HFR).

1. “Hold for release” instructions shall be used when necessary to inform a pilot or a controller that a departure clearance is not valid until additional instructions are received.

REFERENCE-

P/CG Term- Hold for Release.

2. When issuing hold for release instructions, include departure delay information.

PHRASEOLOGY-

(Aircraft identification) CLEARED TO (destination) AIRPORT AS FILED, MAINTAIN (altitude),

and if required,

(additional instructions or information).

HOLD FOR RELEASE, EXPECT (time in hours and/or minutes) DEPARTURE DELAY.

3. When conditions allow, release the aircraft as soon as possible.

PHRASEOLOGY-

To another controller,

(aircraft identification) RELEASED.

To a flight service specialist,

ADVISE (aircraft identification) RELEASED FOR DEPARTURE.

To a pilot at an airport not served by a control tower,

(aircraft identification) RELEASED FOR DEPARTURE.

c. Release Times.

1. Release times shall be issued to pilots when necessary to specify the earliest time an aircraft may depart.

NOTE–

A release time is a departure restriction issued to a pilot (either directly or through authorized relay) to separate a departing aircraft from other traffic.

2. The facility issuing a release time to a pilot shall include a time check.

PHRASEOLOGY–

(Aircraft identification) RELEASED FOR DEPARTURE AT (time in hours and/or minutes),

and if required,

IF NOT OFF BY (time), ADVISE (facility) NOT LATER THAN (time) OF INTENTIONS.

TIME (time in hours, minutes, and nearest quarter minute).

d. When expect departure clearance times (EDCT) are assigned through a ground delay program, the departure terminal shall, to the extent possible, plan ground movement of aircraft destined to the affected airport(s) so that flights are sequenced to depart no earlier than 5 minutes before, and no later than 5 minutes after the EDCT. Do not release aircraft on their assigned EDCT if a ground stop (GS) applicable to that aircraft is in effect, unless approval has been received from the originator of the GS.

1. If an aircraft has begun to taxi or requests taxi in a manner consistent with meeting the EDCT, the aircraft shall be released. Additional coordination is not required.

2. If an aircraft requests taxi or clearance for departure inconsistent with meeting the EDCT window, ask the pilot to verify the EDCT.

(a) If the pilot's EDCT is the same as the FAA EDCT, the aircraft is released consistent with the EDCT.

(b) If the pilot's EDCT is not the same as the FAA EDCT, refer to Trust and Verify Note below.

3. If an aircraft requests taxi too late to meet the EDCT, contact the ATCSCC through the appropriate TMU.

NOTE–

(Trust & Verify) EDCTs are revised by Air Carriers and Traffic Management for changing conditions en route or at affected airport(s). Terminal controllers use of aircraft reported EDCT for departure sequencing should be verified with the appropriate TMU prior to departure if this can be accomplished without the aircraft incurring delay beyond the EDCT reported by the aircraft. The preferred method for verification is the Flight Schedule Monitor (FSM). If the EDCT cannot be verified without incurring additional delay, the aircraft should be released based on the pilot reported EDCT. The aircraft operator is responsible for operating in a manner consistent to meet the EDCT.

4-3-5. GROUND STOP

Do not release an aircraft if a ground stop (GS) applicable to that aircraft is in effect, without the approval of the originator of the GS.

4-3-6. DELAY SEQUENCING

When aircraft elect to take delay on the ground before departure, issue departure clearances to them in the order in which the requests for clearance were originally made if practicable.

4-3-7. FORWARD DEPARTURE DELAY INFORMATION

Inform approach control facilities and/or towers of anticipated departure delays.

4-3-8. COORDINATION WITH RECEIVING FACILITY

a. Coordinate with the receiving facility before the departure of an aircraft if the departure point is less than 15 minutes flying time from the transferring facility's boundary unless an automatic transfer of data between automated systems will occur, in which case, the flying time requirement may be reduced to 5 minutes or replaced with a mileage from the boundary parameter when mutually agreeable to both facilities.

NOTE–

Agreements requiring additional time are encouraged between facilities that need earlier coordination. However, when agreements establish mandatory radar handoff procedures, coordination needs only be effected in a timely manner prior to transfer of control.

REFERENCE–

FAAO 7110.65, Chapter 5, Section 4, Transfer of Radar Identification, Application, Para 5-4-1

b. The actual departure time or a subsequent strip posting time shall be forwarded to the receiving facility unless assumed departure times are agreed upon and that time is within 3 minutes of the actual departure time.

■ 4-3-9. VFR RELEASE OF IFR DEPARTURE

When an aircraft which has filed an IFR flight plan requests a VFR departure through a terminal facility, FSS, or air/ground communications station:

a. After obtaining, if necessary, approval from the facility/sector responsible for issuing the IFR clearance, you may authorize an IFR flight planned aircraft to depart VFR. Inform the pilot of the proper frequency and, if appropriate, where or when to contact the facility responsible for issuing the clearance.

PHRASEOLOGY-

VFR DEPARTURE AUTHORIZED. CONTACT (facility) ON (frequency) AT (location or time if required) FOR CLEARANCE.

b. If the facility/sector responsible for issuing the clearance is unable to issue a clearance, inform the

pilot, and suggest that the delay be taken on the ground. If the pilot insists upon taking off VFR and obtaining an IFR clearance in the air, inform the facility/sector holding the flight plan of the pilot's intentions and, if possible, the VFR departure time.

4-3-10. FORWARDING DEPARTURE TIMES ■

TERMINAL

Unless alternate procedures are prescribed in a letter of agreement or automatic departure messages are being transmitted between automated facilities, forward departure times to the facility from which you received the clearance and also to the terminal departure controller when that position is involved in the departure sequence.

NOTE-

1. Letters of agreement prescribing assumed departure times or mandatory radar handoff procedures are alternatives for providing equivalent procedures.

2. The letters "DM" flashing in the data block signify unsuccessful transmission of a departure message.

REFERENCE-

FAAO 7210.3, *Automatic Acquisition/Termination Areas, Para 11-2-6.*

Section 4. Route Assignment

4-4-1. ROUTE USE

Clear aircraft via routes consistent with the altitude stratum in which the operation is to be conducted by one or more of the following:

NOTE-

Except for certain NAVAIDS/routes used by scheduled air carriers or authorized for specific uses in the control of IFR aircraft, Air Traffic Service (ATS) routes, and NAVAIDS established for use at specified altitudes are shown on U.S. government charts or DOD FLIP charts.

REFERENCE-

FAAO 7110.65, NAVAID Terms, Para 2-5-2

FAAO 7110.65, Exceptions, Para 4-1-2

FAAO 7110.65, Minimum En Route Altitudes, Para 4-5-6

FAAO 7110.65, Application, Para 5-6-1

- a. Designated ATS routes.

PHRASEOLOGY-

VIA:

VICTOR (color) (airway number)(the word Romeo when RNAV for existing Alaska routes),

or

J (route number) (the word Romeo when RNAV for existing Alaska routes),

or

SUBSTITUTE (ATS route) FROM (fix) to (fix),

or

IR (route number).

CROSS/JOIN VICTOR/(color) (airway number), (number of miles) MILES (direction) OF (fix).

b. Radials, courses, azimuths, or direct to or from NAVAIDs.

PHRASEOLOGY-

DIRECT.

VIA;

(name of NAVAID) (specified) RADIAL/COURSE/AZIMUTH,

or

(fix) AND (fix),

or

RADIALS OF (ATS route) AND (ATS route).

- c. DME arcs of VORTAC, MLS, or TACAN aids.

d. Radials, courses, azimuths, and headings of departure or arrival routes.

- e. DPs/STARs/FMSPs.

- f. Vectors.

g. Fixes defined in terms of degree-distance from NAVAIDs for special military operations.

h. Courses, azimuths, bearings, quadrants, or radials within a radius of a NAVAID.

PHRASEOLOGY-

CLEARED TO FLY (general direction from NAVAID) OF (NAVAID name and type) BETWEEN (specified) COURSES TO/BEARINGS FROM/RADIALS (NAVAID name when a NDB) WITHIN (number of miles) MILE RADIUS,

or

CLEARED TO FLY (specified) QUADRANT OF (NAVAID name and type) WITHIN (number of miles) MILE RADIUS.

or

CLEARED TO FLY (general direction from MLS) OF (name or MLS) BETWEEN (specified) AZIMUTHS WITHIN/BETWEEN (number of miles) MILE RADIUS.

EXAMPLE-

1. "Cleared to fly east of Allentown VORTAC between the zero four five and the one three five radials within four zero mile radius."

2. "Cleared to fly east of Crystal Lake radio beacon between the two two five and the three one five courses to Crystal Lake within three zero mile radius."

3. "Cleared to fly northeast quadrant of Philipsburg VORTAC within four zero mile radius."

"Cleared to fly east of the Montgomery M-L-S runway two eight left between the two seven zero and the two four zero azimuth within a 5 mile radius."

i. Fixes/waypoints defined in terms of:

1. Published name; or
2. Degree-distance from NAVAIDs; or

3. Latitude/longitude coordinates, state the latitude and longitude in degrees and minutes including the direction from the axis such as North or West; or

PHRASEOLOGY-

*“32 DEGREES, 45 MINUTES NORTH,
105 DEGREES, 37 MINUTES WEST.”*

4. Offset from published or established ATS route at a specified distance and direction for random (impromptu) RNAV Routes.

PHRASEOLOGY-

DIRECT (fix/waypoint)

DIRECT TO THE (facility) (radial) (distance) FIX.

OFFSET(distance) RIGHT/LEFT OF (route).

EXAMPLE-

“Direct SUNOL.”

“Direct to the Appleton three one zero radial two five mile fix.”

“Offset eight miles right of Victor six.”

j. RNAV aircraft transitioning to/from High Altitude Redesign (HAR) or Point-to-point (PTP) operations via pitch/catch points.

REFERENCE-

FAAO 7110.65, Aircraft Equipment Suffix, Para 2-3-7

FAAO 7110.65, NAVAID Fixes, Para 2-5-3

FAAO 7110.65, Chapter 5, Section 5, Radar Separation, Application, Para 5-5-1

4-4-2. ROUTE STRUCTURE TRANSITIONS

To effect transition within or between route structure, clear an aircraft by one or more of the following methods, based on VOR, VORTAC, TACAN, or MLS NAVAIDs (unless use of other NAVAIDs are essential to aircraft operation or ATC efficiency):

a. Vector aircraft to or from radials, courses, or azimuths of the ATS route assigned.

b. Assign a DP/STAR/FMSP.

c. Clear departing or arriving aircraft to climb or descend via radials, courses, or azimuths of the ATS route assigned.

d. Clear departing or arriving aircraft directly to or between the NAVAIDs forming the ATS route assigned.

e. Clear aircraft to climb or descend via the ATS route on which flight will be conducted.

f. Clear aircraft to climb or descend on specified radials, courses, or azimuths of NAVAIDs.

g. Provide radar monitor when transition to or from a designated or established RNAV route is made along random RNAV routes.

h. Clear RNAV aircraft transitioning to or between designated or established RNAV routes direct to a named waypoint on the new route.

4-4-3. DEGREE-DISTANCE ROUTE DEFINITION FOR MILITARY OPERATIONS

EN ROUTE

a. Do not accept a military flight plan whose route or route segments do not coincide with designated airways or jet routes or with a direct course between NAVAIDs unless it is authorized in subpara b and meets the following degree-distance route definition and procedural requirements:

1. The route or route segments shall be defined in the flight plan by degree-distance fixes composed of:

- (a) A location identifier;
- (b) Azimuth in degrees magnetic; and
- (c) Distance in miles from the NAVAID used.

EXAMPLE-

“MKE 030025.”

2. The NAVAIDs selected to define the degree-distance fixes shall be those authorized for use at the altitude being flown and at a distance within the published service volume area.

3. The distance between the fixes used to define the route shall not exceed:

- (a) Below FL 180- 80 miles;
- (b) FL 180 and above- 260 miles; and
- (c) For celestial navigation routes, all altitudes- 260 miles.

4. Degree-distance fixes used to define a route shall be considered compulsory reporting points except that an aircraft may be authorized by ATC to omit reports when traffic conditions permit.

5. Military aircraft using degree-distance route definition procedures shall conduct operations in accordance with the following:

(a) Unless prior coordination has been effected with the appropriate air traffic control facility, flight plan the departure and the arrival phases to conform with the routine flow of traffic when operating within 75 miles of the departure and the arrival airport. Use defined routes or airways or direct courses between NAVAIDs or as otherwise required to conform to the normal flow of traffic.

(b) Flight plans must be filed at least 2 hours before the estimated time of departure.

b. The following special military operations are authorized to define routes, or portions of routes, by degree-distance fixes:

1. Airborne radar navigation, radar bomb scoring (RBS), and airborne missile programming conducted by the USAF, USN, and RAF.

2. Celestial navigation conducted by the USAF, USN, and RAF.

3. Target aircraft operating in conjunction with air defense interceptors, and air defense interceptors while en route to and from assigned airspace.

4. Missions conducted above FL 450.

5. USN fighter and attack aircraft operating in positive control airspace.

6. USN/USMC aircraft, TACAN equipped, operating within the Honolulu FIR/Hawaiian airways area.

7. USAF/USN/USMC aircraft flight planned to operate on MTRs.

8. USAF Air Mobility Command (AMC) aircraft operating on approved station-keeping equipment (SKE) routes in accordance with the conditions and limitations listed in FAA Exemption No. 4371 to 14 CFR Section 91.177(a)(2) and 14 CFR Section 91.179(b)(1).

4-4-4. ALTERNATIVE ROUTES

When any part of an airway or route is unusable because of NAVAID status, clear aircraft other than /E, /F, /G, or /R, via one of the following alternative routes:

a. A route depicted on current U.S. Government charts/publications. Use the word “substitute” immediately preceding the alternative route in issuing the clearance.

b. A route defined by specifying NAVAID radials, courses, or azimuths.

c. A route defined as direct to or between NAVAIDs.

d. Vectors.

NOTE-

Inform area navigation aircraft that will proceed to the NAVAID location of the NAVAID outage.

4-4-5. CLASS G AIRSPACE

Include routes through Class G airspace only when requested by the pilot.

NOTE-

1. *Flight plans filed for random RNAV routes through Class G airspace are considered a request by the pilot.*

2. *Flight plans containing MTR segments in/through Class G airspace are considered a request by the pilot.*

4-4-6. DIRECT CLEARANCES

a. Do not issue a routing clearance that will take an aircraft off of its flight plan route if the destination airport is included in a ground delay program (GDP), ground stop (GS), or Playbook route, when known, unless operational necessity dictates.

b. *EN ROUTE*. Do not issue revised routing clearances that will take an aircraft off its flight plan route past the last fix in your facility’s airspace, unless requested by the pilot or operational necessity dictates.

NOTE-

Nothing in this paragraph shall preclude a controller from issuing a routing clearance that conforms to a letter of agreement or standard operating procedure within their own facility or between facilities, is required to maintain separation or comply with traffic flow management initiatives.

Section 5. Altitude Assignment and Verification

4-5-1. VERTICAL SEPARATION MINIMA

Separate instrument flight rules (IFR) aircraft using the following minima between altitudes:

- a. Up to and including FL 410– 1,000 feet.
- b. Apply 2,000 feet at or above FL 290 between non-RVSM aircraft and all other aircraft at or above FL 290.

NOTE-
Aircraft operating in a formation flight are considered non-RVSM aircraft regardless of their single-ship status.

REFERENCE-
FAAO 7110.65, Formation Flights, Para 2-1-13.
FAAO 7110.65, Additional Separation for Formation Flights, Para 5-5-8.
P/CG Term – Formation Flight.

- c. Above FL 410– 2,000 feet, except:
 - 1. In oceanic airspace, above FL 450 between a supersonic and any other aircraft– 4,000 feet.
 - 2. Above FL 600 between military aircraft– 5,000 feet.

NOTE-
Oceanic separation procedures are supplemented in Chapter 8; Section 7, Section 8, Section 9, and Section 10.

REFERENCE-
FAAO 7110.65, Vertical Application, Para 5-5-5
FAAO 7110.65, Application, Para 6-6-1
FAAO 7110.65, Military Operations Above FL 600, Para 9-3-13

4-5-2. FLIGHT DIRECTION

Clear aircraft at altitudes according to the TBL 4-5-1.

TBL 4-5-1
Altitude Assignment

Aircraft Operating	On course degrees magnetic	Assign	Examples
Below 3,000 feet above surface	Any course	Any altitude	
At and below FL 410	0 through 179	Odd cardinal altitude or flight levels at intervals of 2,000 feet	3,000, 5,000, FL 310, FL 330
	180 through 359	Even cardinal altitude or flight levels at intervals of 2,000 feet	4,000, 6,000, FL 320, FL 340
Above FL 410	0 through 179	Odd cardinal flight levels at intervals of 4,000 feet beginning with FL 450	FL 450, FL 490, FL 530
	180 through 359	Odd cardinal flight levels at intervals of 4,000 feet beginning with FL 430	FL 430, FL 470, FL 510
One way routes (except in composite systems)	Any course	Any cardinal altitude or flight level below FL 410 or any odd cardinal flight level above FL 410	FL 270, FL 280, FL 290, FL 300, FL 310, FL 410, FL 430, FL 450
Within an ALTRV	Any course	Any altitude or flight level	
In transition to/from or within Oceanic airspace where composite separation is authorized	Any course	Any odd or even cardinal flight level including those above FL 290	FL 280, FL 290, FL 300, FL 310, FL 320, FL 330, FL 340
In aerial refueling tracks and anchors	Any course	Altitude blocks as requested. Any altitude or flight level	050B080, FL 180B220, FL 280B310
Aircraft within Oceanic RVSM or RVSM transition airspace	Any course	Any designated cardinal altitude	FL 330, FL 340, FL 350, FL 360

NOTE-

Oceanic separation procedures are supplemented in Chapter 8; Section 7, Section 8, Section 9, and Section 10.

REFERENCE-

*FAAO 7110.65, Exceptions, Para 4-5-3
FAAO 7110.65, Altitude Assignments, Para 7-7-5
FAAO 7110.65, Separation Minima, Para 9-4-2*

4-5-3. EXCEPTIONS

When traffic, meteorological conditions, or aircraft operational limitations prevent assignment of altitudes prescribed in para 4-5-2, Flight Direction, assign any cardinal altitude or flight level below FL 410 or any odd cardinal flight level at or above FL 410 without regard to direction of flight as follows:

NOTE-

See para 2-3-9 Control Symbology, for control abbreviations and symbols to be used in conjunction with this paragraph.

a. For traffic conditions, take this action only if one of the following conditions exists:

1. Aircraft remain within a facility's area and prior approval is obtained from other affected positions or sectors or the operations are covered in a Facility Directive.

2. Aircraft will proceed beyond the facility's area and specific operations and procedures permitting random altitude assignment are covered in a letter of agreement between the appropriate facilities.

NOTE-

Those en route facilities using host software that provides capability for passing interim altitude shall include the specific operations and procedures for use of this procedure in a letter of agreement between the appropriate facilities.

b. Military aircraft are operating on random routes and prior approval is obtained from the facility concerned.

c. For meteorological conditions, take this action only if you obtain prior approval from other affected positions or sectors within your facility and, if necessary, from the adjacent facility concerned.

d. For aircraft operational limitations, take this action only if the pilot informs you the available appropriate altitude exceeds the operational limitations of his/her aircraft and only after you obtain prior approval from other affected positions or sectors within your facility and, if necessary, from the adjacent facility concerned.

e. For mission requirements, take this action only when the aircraft is operating on an MTR.

REFERENCE-

*FAAO 7110.65, Altitude Assignments, Para 7-7-5
FAAO 7110.65, Separation Minima, Para 9-4-2*

4-5-4. LOWEST USABLE FLIGHT LEVEL

If a change in atmospheric pressure affects a usable flight level in your area of jurisdiction, use TBL 4-5-2 to determine the lowest usable flight level to clear aircraft at or above 18,000 feet MSL.

TBL 4-5-2

Lowest Usable FL

Altimeter Setting	Lowest Usable FL
29.92" or higher	180
29.91" to 28.92"	190
28.91" to 27.92"	200

REFERENCE-

FAAO 7110.65, Separation Minima, Para 9-4-2

4-5-5. ADJUSTED MINIMUM FLIGHT LEVEL

When the prescribed minimum altitude for IFR operations is at or above 18,000 feet MSL and the atmospheric pressure is less than 29.92", add the appropriate adjustment factor from TBL 4-5-3 to the flight level equivalent of the minimum altitude in feet to determine the adjusted minimum flight level.

TBL 4-5-3

Minimum FL Adjustment

Altimeter Setting	Adjustment Factor
29.92" or higher	None
29.91" to 29.42"	500 feet
29.41" to 28.92"	1,000 feet
28.91" to 28.42"	1,500 feet
28.41" to 27.92"	2,000 feet

4-5-6. MINIMUM EN ROUTE ALTITUDES

Except as provided in subparas a and b below, assign altitudes at or above the MEA for the route segment being flown. When a lower MEA for subsequent segments of the route is applicable, issue the lower MEA only after the aircraft is over or past the Fix/NAVAID beyond which the lower MEA applies unless a crossing restriction at or above the higher MEA is issued.

a. An aircraft may be cleared below the MEA but not below the MOCA for the route segment being flown if the altitude assigned is at least 300 feet above the floor of controlled airspace and one of the following conditions are met:

NOTE-

Controllers must be aware that in the event of radio communications failure, a pilot will climb to the MEA for the route segment being flown.

1. Nonradar procedures are used only within 22 miles of a VOR, VORTAC, or TACAN.

2. Radar procedures are used only when an operational advantage is realized and the following actions are taken:

(a) Radar navigational guidance is provided until the aircraft is within 22 miles of the NAVAID, and

(b) Lost communications instructions are issued.

b. An aircraft may be cleared to operate on jet routes below the MEA (but not below the prescribed minimum altitude for IFR operations) or above the maximum authorized altitude if, in either case, radar service is provided.

NOTE-

Minimum en route and maximum authorized altitudes for certain jet route segments have been established above the floor of the jet route structure due to limitations on navigational signal coverage.

c. Where a higher altitude is required because of an MEA, the aircraft shall be cleared to begin climb to the higher MEA as follows:

1. If no MCA is specified, prior to or immediately after passing the fix where the higher MEA is designated. (See FIG 4-5-1.)

FIG 4-5-1

No MCA Specified

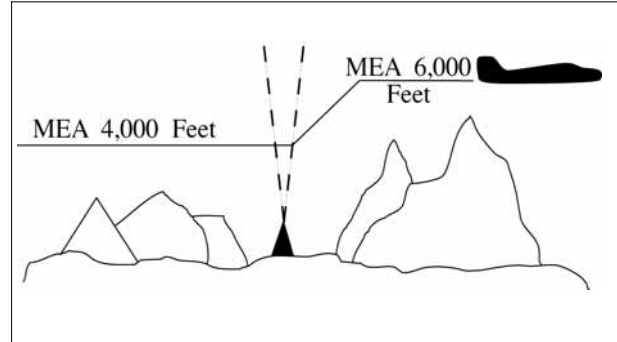

2. If a MCA is specified, prior to the fix so as to cross the fix at or above the MCA. (See FIG 4-5-2.)

FIG 4-5-2

MCA Specified

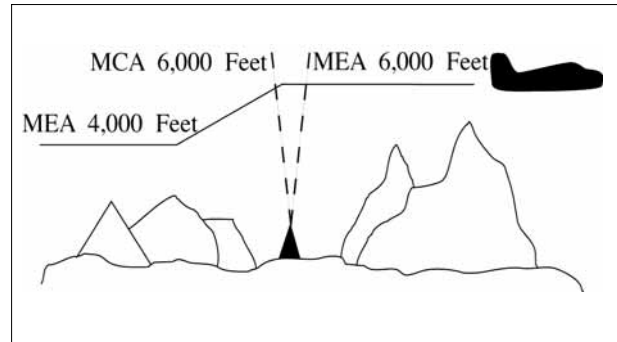

d. Where MEAs have not been established, clear an aircraft at or above the minimum altitude for IFR operations prescribed by 14 CFR Section 91.177.

REFERENCE-

- FAAO 7110.65, IFR-VFR and VFR-IFR Flights, Para 4-2-8
- FAAO 7110.65, Route Use, Para 4-4-1
- FAAO 7110.65, Chapter 5, Section 6, Application, Para 5-6-1
- FAAO 7110.65, Altitude Assignments, Para 7-7-5

4-5-7. ALTITUDE INFORMATION

Issue altitude instructions as follows:

REFERENCE-

- FAAO 7110.65, Clearance Items, Para 4-2-1

a. Altitude to maintain or cruise. When issuing cruise in conjunction with an airport clearance limit and an unpublished route will be used, issue an appropriate crossing altitude to ensure terrain clearance until the aircraft reaches a fix, point, or route where the altitude information is available to

the pilot. When issuing a cruise clearance to an airport which does not have a published instrument approach, a cruise clearance without a crossing restriction may be issued.

PHRASEOLOGY–

MAINTAIN/CRUISE (altitude). MAINTAIN (altitude) UNTIL (time, fix, waypoint),

or

(number of miles or minutes) MILES/MINUTES PAST (fix, waypoint).

CROSS (fix, point, waypoint),

or

INTERCEPT (route) AT OR ABOVE (altitude), CRUISE (altitude).

NOTE–

1. The crossing altitude must assure IFR obstruction clearance to the point where the aircraft is established on a segment of a published route or instrument approach procedure.

2. When an aircraft is issued a cruise clearance to an airport which does not have a published instrument approach procedure, it is not possible to satisfy the requirement for a crossing altitude that will ensure terrain clearance until the aircraft reaches a fix, point, or route where altitude information is available to the pilot. Under those conditions, a cruise clearance without a crossing restriction authorizes a pilot to determine the minimum IFR altitude as prescribed in 14 CFR Section 91.177 and descend to it at pilot discretion if it is lower than the altitude specified in the cruise clearance.

b. Instructions to climb or descend including restrictions, as required. Specify a time restriction reference the UTC clock reading with a time check. If you are relaying through an authorized communications provider, such as ARINC, FSS, etc., advise the radio operator to issue the current time to the aircraft when the clearance is relayed. The requirement to issue a time check shall be disregarded if the clearance is issued via Controller Pilot Data Link Communications (CPDLC).

EXAMPLE–

1. “United Four Seventeen, climb to reach one three thousand at two two one five.”

“Time two two one one and one-quarter.”

The pilot is expected to be level at 13,000 feet at 2215 UTC.

2. Through Relay – “Speedbid Five, climb to reach flight level three-five zero at one-two-one-five, time” (Issue a time check).

REFERENCE–

FAAO 7110.65, Word Meanings, Para 1-2-1

FAAO 7110.65, Numbers Usage, Para 2-4-17

PHRASEOLOGY–

CLIMB/DESCEND AND MAINTAIN (altitude).

If required,

AFTER PASSING (fix, waypoint),

or

AT (time) (time in hours, minutes, and nearest quarter minute).

CLIMB/DESCEND TO REACH (altitude)

AT (time (issue time check) or fix, waypoint),

or

AT (time). CLIMB/DESCEND AND MAINTAIN (altitude) WHEN ESTABLISHED AT LEAST (number of miles or minutes) MILES/MINUTES PAST (fix, waypoint) ON THE (NAVAID) (specified) RADIAL.

CLIMB/DESCEND TO REACH (altitude) AT (time or fix, waypoint),

or

A POINT (number of miles) MILES (direction) OF (name of DME NAVAID),

or

MAINTAIN (altitude) UNTIL (time (issue time check), fix, waypoint), THEN CLIMB/DESCEND AND MAINTAIN (altitude).

Through relay:

CLIMB TO REACH (altitude) AT (time) (issue a time check).

c. Specified altitude over a specified fix, waypoint.

PHRASEOLOGY-

CROSS (fix, waypoint) AT (altitude).

CROSS (fix, waypoint) AT OR ABOVE/BELOW (altitude).

d. A specified altitude over a specified fix for that portion of a descent clearance where descent at pilot's discretion is permissible. At any other time it is practicable, authorize climb/descent at pilot's discretion.

PHRASEOLOGY-

CLIMB/DESCEND AT PILOT'S DISCRETION.

EXAMPLE-

"United Four Seventeen, descend and maintain six thousand."

NOTE-

The pilot is expected to commence descent upon receipt of the clearance and to descend at the suggested rates specified in the AIM, para 4-4-9, Adherence to Clearance, until reaching the assigned altitude of 6,000 feet.

EXAMPLE-

"United Four Seventeen, descend at pilot's discretion, maintain six thousand."

NOTE-

The pilot is authorized to conduct descent within the context of the term "at pilot's discretion" as described in the AIM.

EXAMPLE-

"United Four Seventeen cross Lakeview V-O-R at or above flight level two zero zero, descend and maintain six thousand."

NOTE-

The pilot is authorized to conduct descent "at pilot's discretion" until reaching Lakeview VOR. The pilot must comply with the clearance provision to cross the Lakeview VOR at or above FL 200, and after passing Lakeview VOR, the pilot is expected to descend at the rates specified in the AIM until reaching the assigned altitude of 6,000 feet.

EXAMPLE-

"United Four Seventeen, cross Lakeview V-O-R at and maintain six thousand."

NOTE-

The pilot is authorized to conduct descent "at pilot's discretion," but must comply with the clearance provision to cross Lakeview VOR at 6,000 feet.

EXAMPLE-

"United Four Seventeen, descend now to flight level two seven zero, cross Lakeview V-O-R at or below one zero thousand, descend and maintain six thousand."

NOTE-

The pilot is expected to promptly execute and complete descent to FL 270 upon receipt of the clearance. After reaching FL 270, the pilot is authorized to descend "at pilot's discretion" until reaching Lakeview VOR. The pilot must comply with the clearance provision to cross Lakeview VOR at or below 10,000 feet. After Lakeview VOR, the pilot is expected to descend at the rates specified in the AIM until reaching 6,000 feet.

NOTE-

1. *A descent clearance which specifies a crossing altitude authorizes descent at pilot's discretion for that portion of the flight to which the crossing altitude restriction applies.*

2. *Any other time that authorization to descend at pilot's discretion is intended, it must be specifically stated by the controller.*

3. *The pilot may need to know of any future restrictions that might affect the descent, including those that may be issued in another sector, in order to properly plan a descent at pilot's discretion.*

4. *Controllers need to be aware that the descent rates in the AIM are only suggested and aircraft will not always descend at those rates.*

REFERENCE-

P/CG Term- Pilot's Discretion.

e. *When a portion of a climb/descent may be authorized at the pilot's discretion, specify the altitude the aircraft must climb/descent to followed by the altitude to maintain at the pilot's discretion.*

PHRASEOLOGY-

CLIMB/DESCEND NOW TO (altitude), THEN CLIMB/DESCEND AT PILOT'S DISCRETION MAINTAIN (altitude).

EXAMPLE-

"United Three Ten, descend now to flight level two eight zero, then descend at pilot's discretion maintain flight level two four zero."

NOTE-

1. *The pilot is expected to commence descent upon receipt of the clearance and to descend at the suggested rates specified in the AIM, para 4-4-9, Adherence to Clearance, until reaching FL 280. At that point, the pilot is authorized to continue descent to FL 240 within the context of the term "at pilot's discretion" as described in the AIM.*

2. *Controllers need to be aware that the descent rates in the AIM are only suggested and aircraft will not always descend at those rates.*

f. When the “pilot’s discretion” portion of a climb/descent clearance is being canceled by assigning a new altitude, inform the pilot that the new altitude is an “amended altitude.”

EXAMPLE–

“American Eighty Three, amend altitude, descend and maintain Flight Level two six zero.”

NOTE–

American Eighty Three, at FL 280, has been cleared to descend at pilot’s discretion to FL 240. Subsequently, the altitude assignment is changed to FL 260. Therefore, pilot’s discretion is no longer authorized.

g. Altitude assignments involving more than one altitude.

PHRASEOLOGY–

MAINTAIN BLOCK (altitude) THROUGH (altitude).

h. Instructions to vertically navigate on a STAR/RNAV STAR/FMSP with published restrictions.

PHRASEOLOGY–

DESCEND VIA (STAR/RNAV STAR/FMSP name and number)

TERMINAL: DESCEND VIA (STAR/RNAV STAR/FMSP name and number and runway number).

EXAMPLE–

“Descend via the Mudde One Arrival.”

“Cross JCT at flight level two four zero, then descend via the Coast Two Arrival.”

TERMINAL: “Descend via the Lendy One Arrival, Runway 22 left.”

NOTE–

Clearance to “descend via” authorizes pilots:

1. To vertically and laterally navigate on a STAR/RNAV STAR/FMSP.
2. When cleared to a waypoint depicted on a STAR/RNAV STAR/FMSP, to descend from a previously assigned altitude at pilot’s discretion to the altitude depicted for that waypoint, and once established on the depicted arrival, to navigate laterally and vertically to meet all published restrictions. ATC is responsible for obstacle clearance when issuing a “descend via” clearance from a previously assigned altitude.

REFERENCE–

FAAO 7110.65, Minimum En Route Altitudes, Para 4–5–6.

FAAO 7110.65, Separation From Obstructions, Para 5–5–9.

NOTE–

3. Pilots navigating on a STAR/RNAV STAR/FMSP shall maintain last assigned altitude until receiving clearance to “descend via.”
4. Pilots cleared for vertical navigation using the phraseology “descend via” shall inform ATC upon initial contact.

EXAMPLE–

“Delta One Twenty One leaving FL 240, descending via the Civit One arrival.”

REFERENCE–

AIM, Standard Terminal Arrival (STAR), Area Navigation (RNAV) STAR, and Flight Management System Procedures (FMSP) for Arrivals, Para 5–4–1a2.

1. Assign an altitude to cross the waypoint/fix, if no altitude is depicted at the waypoint/fix, for aircraft on a direct routing to a STAR/RNAV STAR/FMSP.

EXAMPLE–

“Proceed direct Luxor, cross Luxor at or above flight level two zero zero, then descend via the Ksino One Arrival.”

2. A descend via clearance shall not be used where procedures contain published “expect” altitude restrictions.

NOTE–

Pilots are not expected to comply with published “expect” restrictions in the event of lost communications, unless ATC has specifically advised the pilot to expect these restrictions as part of a further clearance.

3. If it is necessary to assign a crossing altitude which differs from the STAR/RNAV STAR/FMSP altitude, emphasize the change to the pilot.

PHRASEOLOGY–

DESCEND VIA THE (STAR/FMSP) ARRIVAL EXCEPT CROSS (fix, point, waypoint) (revised altitude information).

EXAMPLE–

“United 454 descend via the Haris One Arrival, except cross Haris at or above one six thousand.”

NOTE–

The aircraft should track laterally and vertically on the Haris One Arrival and should descend so as to cross Haris at or above 16,000; remainder of the arrival shall be flown as published.

4. If it is necessary to assign an interim altitude, or assign a final altitude not contained on a STAR/RNAV STAR/FMSP, the provisions of subpara 4–5–7h may be used in conjunction with subpara 4–5–7a.

PHRASEOLOGY–

DESCEND VIA THE (STAR/RNAV STAR/FMSP) ARRIVAL EXCEPT AFTER (fix) MAINTAIN (revised altitude information).

EXAMPLE–

“United 454 descend via the Haris One Arrival, except after Bruno, maintain one zero thousand.”

NOTE-

The aircraft should track laterally and vertically on the Haris One Arrival and should descend so as to comply with all speed and altitude restrictions until reaching Bruno and then maintain 10,000. Upon reaching 10,000, aircraft should maintain 10,000 until cleared by ATC to continue to descend.

REFERENCE-

FAAO 7110.65 Clearance Information, Para 4-7-1
AIM, Standard Terminal Arrival (STAR), Area Navigation (RNAV) STAR, and Flight Management System Procedures (FMSP) for Arrivals, Para 5-4-1.

i. When a pilot is unable to accept a clearance, issue revised instructions to ensure positive control and standard separation.

NOTE-

1. 14 CFR Section 91.123 states that a pilot is not allowed to deviate from an ATC clearance "that has been obtained...unless an amended clearance is obtained" (except when an emergency exists).

2. A pilot is therefore expected to advise the controller if a clearance cannot be accepted when the clearance is issued. "We will try" and other such acknowledgements do not constitute pilot acceptance of an ATC clearance.

3. Controllers are expected to issue ATC clearances which conform with normal aircraft operational capabilities and do not require "last minute" amendments to ensure standard separation.

4. "Expedite" is not to be used in lieu of appropriate restrictions to ensure separation.

REFERENCE-

FAAO 7110.65, Providing Assistance, Para 10-1-3

4-5-8. ANTICIPATED ALTITUDE CHANGES

If practicable, inform an aircraft when to expect climb or descent clearance or to request altitude change from another facility.

PHRASEOLOGY-

EXPECT HIGHER/LOWER IN (number of miles or minutes) **MILES/MINUTES**,

or

AT (fix). REQUEST ALTITUDE/FLIGHT LEVEL CHANGE FROM (name of facility).

If required,

AT (time, fix, or altitude).

REFERENCE-

FAAO 7110.65, IFR Flight Progress Data, Para 2-2-6

4-5-9. ALTITUDE CONFIRMATION-NONRADAR

a. Request a pilot to confirm assigned altitude on initial contact and when position reports are received unless:

NOTE-

For the purpose of this paragraph, "initial contact" means a pilot's first radio contact with each sector/position.

1. The pilot states the assigned altitude, or

2. You assign a new altitude to a climbing or descending aircraft, or

3. **TERMINAL**. The aircraft was transferred to you from another sector/position within your facility (intrafacility).

PHRASEOLOGY-

(In level flight situations),

VERIFY AT (altitude/flight level).

(In climbing/descending situations),

(if aircraft has been assigned an altitude below the lowest useable flight level),

VERIFY ASSIGNED ALTITUDE (altitude).

(If aircraft has been assigned a flight level at or above the lowest useable flight level),

VERIFY ASSIGNED FLIGHT LEVEL (flight level).

b. **USA**. Reconfirm all pilot altitude read backs.

PHRASEOLOGY-

(If altitude read back is correct),

AFFIRMATIVE (altitude).

(If altitude read back is not correct),

NEGATIVE. CLIMB/DESCEND AND MAINTAIN (altitude),

or

NEGATIVE. MAINTAIN (altitude).

Section 6. Holding Aircraft

4-6-1. CLEARANCE TO HOLDING FIX

Consider operational factors such as length of delay, holding airspace limitations, navigational aids, altitude, meteorological conditions when necessary to clear an aircraft to a fix other than the destination airport. Issue the following:

a. Clearance limit (if any part of the route beyond a clearance limit differs from the last routing cleared, issue the route the pilot can expect beyond the clearance limit).

PHRASEOLOGY-

EXPECT FURTHER CLEARANCE VIA (routing).

EXAMPLE-

“Expect further clearance via direct Stillwater V-O-R, Victor Two Twenty-Six Snapy intersection, direct Newark.”

b. Holding instructions.

1. Holding instructions may be eliminated when you inform the pilot that no delay is expected.

2. When the pattern is charted, you may omit all holding instructions except the charted holding direction and the statement “as published.” Always issue complete holding instructions when the pilot requests them.

NOTE-

The most generally used holding patterns are depicted on U.S. Government or commercially produced low/high altitude en route, area, and STAR Charts.

PHRASEOLOGY-

CLEARED TO (fix), HOLD (direction), AS PUBLISHED,

or

CLEARED TO (fix), NO DELAY EXPECTED.

c. EFC. Do not specify this item if no delay is expected.

1. When additional holding is expected at any other fix in your facility’s area, state the fix and your best estimate of the additional delay. When more than one fix is involved, state the total additional en route delay (omit specific fixes).

NOTE-

Additional delay information is not used to determine pilot action in the event of two-way communications failure. Pilots are expected to predicate their actions solely on the provisions of 14 CFR Section 91.185.

PHRASEOLOGY-

EXPECT FURTHER CLEARANCE (time),

and if required,

ANTICIPATE ADDITIONAL (time in minutes/hours)

MINUTE/HOUR DELAY AT (fix),

or

ANTICIPATE ADDITIONAL (time in minutes/hours)

MINUTE/HOUR EN ROUTE DELAY.

EXAMPLE-

1. *“Expect further clearance one niner two zero, anticipate additional three zero minute delay at Sweet.”*

2. *“Expect further clearance one five one zero, anticipate additional three zero minute en route delay.”*

2. When additional holding is expected in an approach control area, state the total additional terminal delay.

PHRASEOLOGY-

EXPECT FURTHER CLEARANCE (time),

and if required,

ANTICIPATE ADDITIONAL (time in minutes/hours)

MINUTE/HOUR TERMINAL DELAY.

3. TERMINAL. When terminal delays exist or are expected, inform the appropriate center or approach control facility so that the information can be forwarded to arrival aircraft.

4. When delay is expected, issue items in subparas a and b at least 5 minutes before the aircraft is estimated to reach the clearance limit. If the traffic situation requires holding an aircraft that is less than 5 minutes from the holding fix, issue these items immediately.

NOTE-

1. *The AIM indicates that pilots should start speed reduction when 3 minutes or less from the holding fix. The additional 2 minutes contained in the 5-minute requirement are necessary to compensate for different pilot/controller ETAS at the holding fix, minor differences in clock times, and provision for sufficient planning and reaction times.*

2. *When holding is necessary, the phrase “delay indefinite” should be used when an accurate estimate of the*

delay time and the reason for the delay cannot immediately be determined; i.e., disabled aircraft on the runway, terminal or center sector saturation, weather below landing minimums, etc. In any event, every attempt should be made to provide the pilot with the best possible estimate of his/her delay time and the reason for the delay. Controllers/supervisors should consult, as appropriate, with personnel (other sectors, weather forecasters, the airport management, other facilities, etc.) who can best provide this information.

PHRASEOLOGY–

DELAY INDEFINITE, (reason if known), EXPECT FURTHER CLEARANCE (time). (After determining the reason for the delay, advise the pilot as soon as possible.)

EXAMPLE–

“Cleared to Drewe, hold west, as published, expect further clearance via direct Sidney V–O–R one three one five, anticipate additional two zero minute delay at Woody.”

“Cleared to Aston, hold west on Victor two twenty-five, seven mile leg, left turns, expect further clearance one niner two zero, anticipate additional one five minute terminal delay.”

“Cleared to Wayne, no delay expected.”

“Cleared to Wally, hold north, as published, delay indefinite, snow removal in progress, expect further clearance one one three zero.”

4–6–2. CLEARANCE BEYOND FIX

a. If no delay is expected, issue a clearance beyond the clearance limit as soon as possible and, whenever possible, at least 5 minutes before the aircraft reaches the fix.

b. Include the following items when issuing clearance beyond a clearance limit:

1. Clearance limit or approach clearance.

2. Route of flight. Specify one of the following:

(a) Complete details of the route (airway, route, course, fix(es), azimuth course, heading, arc, or vector.)

(b) The phrase “via last routing cleared.” Use this phrase only when the most recently issued routing to the new clearance limit is valid and verbiage will be reduced.

PHRASEOLOGY–

VIA LAST ROUTING CLEARED.

3. Assigned altitude if different from present altitude.

NOTE–

Except in the event of a two-way communications failure, when a clearance beyond a fix has not been received, pilots are expected to hold as depicted on U.S. Government or commercially produced (meeting FAA requirements) low/high altitude en route and area or STAR charts. If no holding pattern is charted and holding instructions have not been issued, pilots should ask ATC for holding instructions prior to reaching the fix. If a pilot is unable to obtain holding instructions prior to reaching the fix, the pilot is expected to hold in a standard pattern on the course on which the aircraft approached the fix and request further clearance as soon as possible.

4–6–3. DELAYS

a. Advise your supervisor or flow controller as soon as possible when you delay or expect to delay aircraft.

b. When arrival delays reach or are anticipated to reach 30 minutes, take the following action:

1. EN ROUTE. The center responsible for transferring control to an approach control facility or, for a nonapproach control destination, the center in whose area the aircraft will land shall issue total delay information as soon as possible after the aircraft enters the center’s area. Whenever possible, the delay information shall be issued by the first center controller to communicate with the aircraft.

2. TERMINAL. When tower en route control service is being provided, the approach control facility whose area contains the destination airport shall issue total delay information as soon as possible after the aircraft enters its approach control area. Whenever possible, the delay information shall be issued by the first terminal controller to communicate with the aircraft.

3. Unless a pilot requests delay information, the actions specified in subparas 1 and 2 above may be omitted when total delay information is available to pilots via ATIS.

PHRASEOLOGY–

(Airport) ARRIVAL DELAYS (time in minutes/hours).

4-6-4. HOLDING INSTRUCTIONS

When issuing holding instructions, specify:

- a. Direction of holding from the fix/waypoint.
- b. Holding fix or waypoint.

NOTE-

The holding fix may be omitted if included at the beginning of the transmission as the clearance limit.

- c. Radial, course, bearing, track, azimuth, airway, or route on which the aircraft is to hold.
- d. Leg length in miles if DME or RNAV is to be used. Specify leg length in minutes if the pilot requests it or you consider it necessary.
- e. Direction of holding pattern turns only if left turns are to be made, the pilot requests it, or you consider it necessary.

PHRASEOLOGY-

HOLD (direction) OF (fix/waypoint) ON (specified radial, course, bearing, track, airway, azimuth(s), or route.)

If leg length is specified,

(number of minutes/miles) MINUTE/MILE LEG.

If direction of turn is specified,

LEFT/RIGHT TURNS.

NOTE-

It is mandatory for the controller to issue left or right turns every time a holding pattern is issued for MLS.

- f. Issue maximum holding airspeed advisories when an aircraft is:
 1. Approved to exceed the maximum airspeed of a pattern, and is cleared into a holding pattern that will protect for the greater speed; or
 2. Observed deviating from the holding pattern airspace area; or
 3. Cleared into an airspeed restricted holding pattern in which the icon has not been published.

EXAMPLE-

Due to turbulence, a turboprop requests to exceed the recommended maximum holding airspeed. ATCS may clear the aircraft into a pattern that protects for the airspeed request, and shall advise the pilot of the maximum holding airspeed for the holding pattern airspace area.

PHRASEOLOGY-

"MAXIMUM HOLDING AIRSPEED IS TWO ONE ZERO KNOTS."

4-6-5. VISUAL HOLDING POINTS

You may use as a holding fix a location which the pilot can determine by visual reference to the surface if he/she is familiar with it.

PHRASEOLOGY-

HOLD AT (location) UNTIL (time or other condition.)

REFERENCE-

FAAO 7110.65, Visual Holding of VFR Aircraft, Para 7-1-4

4-6-6. HOLDING FLIGHT PATH DEVIATION

Approve a pilot's request to deviate from the prescribed holding flight path if obstacles and traffic conditions permit.

4-6-7. UNMONITORED NAVAIDS

Separate an aircraft holding at an unmonitored NAVAID from any other aircraft occupying the course which the holding aircraft will follow if it does not receive signals from the NAVAID.

4-6-8. ILS PROTECTION/CRITICAL AREAS

When conditions are less than reported ceiling 800 feet or visibility of 2 miles, do not authorize aircraft to hold below 5,000 feet AGL inbound toward the airport on or within 1 statute mile of the localizer between the ILS OM or the fix used in lieu of the OM and the airport. *USAF*. The holding restriction applies only when an arriving aircraft is between the ILS OM or the fix used in lieu of the OM and the runway.

REFERENCE-

FAAO 7130.3, Holding Pattern Criteria, Para 54 and FIG 20.

Section 7. Arrival Procedures

4-7-1. CLEARANCE INFORMATION

Clear an arriving aircraft to a clearance limit by specifying the following:

a. Name of fix or airport.

b. Route of flight including a STAR/RNAV STAR/FMSP and STAR/RNAV STAR/FMSP transition, if appropriate. Assign a STAR/RNAV STAR/FMSP and STAR/RNAV STAR/FMSP transition to any aircraft in lieu of other routes; e.g., airways or preferential arrival routes when the routings are the same. The clearance shall include the name and transition, if necessary, of the STAR/RNAV STAR/FMSP to be flown.

TERMINAL: When the STAR/RNAV STAR/FMSP transition is designed to provide course guidance to multiple runways, the facility shall state intended runway number on initial contact, or as soon as practical. If the runway assignment, or any subsequent runway change, is not issued prior to 10 NM from the runway transition waypoint, radar vectors to final shall be provided.

PHRASEOLOGY-

(STAR/RNAV STAR/FMSP name and number) ARRIVAL.

(STAR/RNAV STAR/FMSP name and number) ARRIVAL,
(transition name) TRANSITION.

CHANGE/AMEND TRANSITION TO (runway number).

CHANGE/AMEND TRANSITION TO (runway number)

TURN LEFT/RIGHT or HEADING (heading) FOR
VECTOR TO FINAL APPROACH COURSE.

EXAMPLE-

“Rosewood One arrival.”

“Rosewood One arrival, Delta transition.”

“Change transition to Runway 09 right.”

“Amend transition to Runway 22 left, turn right heading 180 for vector to final approach course.”

NOTE-

If a civil pilot does not wish to use a STAR or FMSP issued in an ATC clearance or any other STAR or FMSP published for that location, the pilot is expected to advise ATC.

c. Altitude instructions, as follows:

1. Assigned altitude; or

2. Instructions to vertically navigate on the STAR/FMSP or STAR/FMSP transition.

EXAMPLE-

“Bayview Three R-NAV Arrival, Helen Transition, maintain Flight Level Three Three Zero.”

“Descend via the Civit One Arrival.”

“Descend via the Lendy One R-NAV Arrival, Runway 22 left.”

“Cross JCT at Flight Level Two Four Zero.”

“Descend via the Coast Two Arrival.”

“Civit One Arrival, Descend and Maintain Flight Level Two Four Zero.”

REFERENCE-

FAAO 7110.65, Altitude Information, Para 4-5-7

AIM, Standard Terminal Arrival (STAR), Area Navigation (RNAV) STAR, and Flight Management System Procedures (FMSP) for Arrivals, Para 5-4-1.

d. Issue holding instructions, EFC, and additional delay information as required.

e. Instructions regarding further communications as appropriate.

REFERENCE-

FAAO 7110.65, Radio Communications Transfer, Para 2-1-17

4-7-2. ADVANCE DESCENT CLEARANCE

EN ROUTE

Take the following action when exercising control of aircraft landing at an airport located in an adjacent center’s control area near the common boundary:

a. Coordinate with the receiving facility for a lower altitude and issue a clearance to the aircraft as appropriate.

b. Initiate this action at a distance sufficient from destination to allow for normal descent and speed reduction.

4-7-3. SINGLE FREQUENCY APPROACHES (SFA)

TERMINAL

Where SFA procedures for military single-piloted turbojet aircraft on an IFR flight plan are contained in a letter of agreement, do not require a radio frequency change after the aircraft begins approach or after initial contact during an en route descent until a landing or low approach has been completed except under the following conditions:

REFERENCE-

FAAO 7610.4, Special Military Operations, Single Frequency Approach (SFA), Para 9-3-6.

P/CG Term- Single-Piloted Aircraft.

- a. During daylight hours while the aircraft is in VFR conditions.
- b. On pilot request.
- c. When pilot cancels IFR flight plan.
- d. In an emergency situation.
- e. When aircraft is cleared for visual approach.

4-7-4. RADIO FREQUENCY AND RADAR BEACON CHANGES FOR MILITARY AIRCRAFT

When military single-piloted turbojet aircraft will conduct an approach wholly or partly in IFR conditions or at night, take the following action:

NOTE-

It is known that the mental distraction and the inadvertent movement of aircraft controls resulting from the pilot's turning, reaching, or leaning to change frequencies can induce spatial disorientation (vertigo).

a. Avoid radio frequency and radar beacon changes to the maximum extent that communications capabilities and traffic will permit. However, when changes are required:

1. Give instructions early enough to allow the change before the aircraft reaches the approach fix or handoff point.
 2. Keep frequency/radar beacon changes to a minimum below 2,500 feet above the surface.
 3. Avoid requiring frequency/radar beacon changes during the time the aircraft is making a turn.
- b. When traffic volume requires, a frequency other than the one used by aircraft making approaches may be assigned for use in transferring control to the approach control facility.

TERMINAL

- c. If practicable, use a frequency common to both the GCA unit and approach control to minimize frequency changes.
- d. When a GCA unit is not able to communicate on a common frequency, a change to a GCA frequency may be authorized.
- e. When a nonradar approach will be made, aircraft may be instructed to change to tower frequency when:
 1. The reported ceiling is at or above 1,500 feet and visibility is 5 statute miles or more.

2. The aircraft reports able to proceed by visual reference to the surface.

3. The aircraft requests and is cleared for a contact approach.

4. The aircraft is cleared for a visual approach.

f. Avoid making frequency/radar beacon changes after an aircraft begins a high altitude approach.

g. In the event of a missed approach, do not require a frequency/radar beacon change before the aircraft reaches the missed approach altitude, the MEA, or the MVA.

REFERENCE-

FAAO 7110.65, Function Code Assignments, Para 5-2-6

4-7-5. MILITARY TURBOJET EN ROUTE DESCENT

Provide military turbojet aircraft the same arrival procedures that are provided for nonmilitary turbojet aircraft except:

NOTE-

It is the responsibility of the pilot to request a high altitude approach if he/she does not want normal arrival handling.

a. An en route descent may be used in a nonradar environment; however, radar capability should exist which will permit the aircraft to be vectored to the final approach course of a published high altitude instrument approach procedure or PAR/ASR approach. Do not use this procedure if other than normal vectoring delays are anticipated.

b. Prior to issuance of a descent clearance below the highest initial approach fix altitude established for any high altitude instrument approach procedure for the destination airport inform the aircraft:

1. Type of approach to expect.

EXAMPLE-

"Expect V-O-R approach to runway three two."

2. Radar vectors will be provided to the final approach course.

EXAMPLE-

"Expect surveillance/precision approach to runway one seven; radar vectors to final approach course."

3. Current weather whenever the ceiling is below 1,000 feet (**USAF:** 1,500 feet) or the highest circling minimum whichever is greater, or when the visibility is less than 3 miles.

EXAMPLE-

"Expect ILS/MLS approach to runway eight; radar vectors to localizer/azimuth course. Weather (reported weather)."

c. If ATIS is provided and the pilot advises he/she has received the current ATIS broadcast before the descent clearance in subpara b is issued, omit those items in subpara b that are contained in the broadcast.

d. To avoid requiring an aircraft to fly at low altitudes for an excessive distance, descent clearance should be issued at a point determined by adding 10 to the first two digits of the flight level.

EXAMPLE-

For FL 370, 37 + 10 = 47 miles.

NOTE-

Turbojet en route descents are based on a rate of descent of 4,000 to 6,000 feet per minute.

e. Do not terminate the en route descent of an aircraft without the consent of the pilot except as required by radar outage or an emergency situation.

REFERENCE-

FAAO 7110.65, Altitude Assignment for Military High Altitude Instrument Approaches, Para 4-8-4

4-7-6. ARRIVAL INFORMATION

EN ROUTE

a. Forward the following information to nonapproach control towers soon enough to permit adjustment of the traffic flow or to FSSs soon enough to provide local airport advisory where applicable:

1. Aircraft identification.
2. Type of aircraft.
3. ETA.

4. Type of instrument approach procedure the aircraft will execute; or

5. For SVFR, the direction from which the aircraft will enter Class B, Class C, Class D, or Class E surface area and any altitude restrictions that were issued; or

6. For aircraft executing a contact approach the position of the aircraft.

NOTE-

Specific time requirements are usually stated in a letter of agreement.

b. Forward the following information to approach control facilities before transfer of control jurisdiction:

NOTE-

Transfer points are usually specified in a letter of agreement.

1. Aircraft identification.

2. Type of aircraft and appropriate aircraft equipment suffix.

3. ETA or actual time, and proposed or actual altitude over clearance limit. The ETA need not be given if the arrival information is being forwarded during a radar handoff.

4. Clearance limit (when other than the destination airport) and EFC issued to the aircraft. Clearance limit may be omitted when provided for in a letter of agreement.

5. Time, fix, or altitude when control responsibility is transferred to the approach control facility. This information may be omitted when provided for in a letter of agreement.

PHRASEOLOGY-

(Identification), (type of aircraft), ESTIMATED/OVER (clearance limit), (time), (altitude), EFC (time).

If required,

YOUR CONTROL,

or

YOUR CONTROL AT (time, fix or altitude).

4-7-7. WEATHER INFORMATION

EN ROUTE

When an available official weather report indicates weather conditions are below a 1,000-foot (USAF: 1,500-foot) ceiling or below the highest circling minimum, whichever is higher, or less than three-miles visibility for the airport concerned, transmit the weather report and changes classified as special weather observations to an arriving aircraft prior to or as part of the approach clearance when:

a. It is transmitted directly to the pilot via center controller-to-pilot communications.

b. It is relayed through a communications station other than an air carrier company radio or through a nonapproach control facility. You may do this by telling the station or nonapproach control facility to issue current weather.

4-7-8. BELOW MINIMA REPORT BY PILOT

If an arriving aircraft reports weather conditions are below his/her landing minima:

NOTE-

Determination that existing weather/visibility is adequate for approach/landing is the responsibility of the pilot/aircraft operator.

- a. Issue appropriate instructions to the aircraft to hold or proceed to another airport.
- b. Adjust, as necessary, the position in the landing sequence of any other aircraft desiring to make approaches and issue approach clearances accordingly.

4-7-9. TRANSFER OF JURISDICTION

Transfer radio communications and control responsibility early enough to allow the receiving facility to clear an aircraft beyond the clearance limit before the aircraft reaches it.

4-7-10. APPROACH INFORMATION

a. Both en route and terminal approach control sectors shall provide current approach information to aircraft destined to airports for which they provide approach control services. This information shall be provided on initial contact or as soon as possible thereafter. Approach information contained in the ATIS broadcast may be omitted if the pilot states the appropriate ATIS code. For pilots destined to an airport without ATIS, items 3-5 below may be omitted after the pilot advises receipt of the automated weather; otherwise, issue approach information by including the following:

1. Approach clearance or type approach to be expected if two or more approaches are published and the clearance limit does not indicate which will be used.
2. Runway if different from that to which the instrument approach is made.
3. Surface wind.
4. Ceiling and visibility if the reported ceiling at the airport of intended landing is below 1,000 feet or below the highest circling minimum, whichever is greater, or the visibility is less than 3 miles.
5. Altimeter setting for the airport of intended landing.

REFERENCE-

FAAO 7110.65, Chapter 2, Section 7, Altimeter Settings.

b. Upon pilot request, controllers shall inform pilots of the frequency where automated weather data may be obtained and, if appropriate, that airport weather is not available.

PHRASEOLOGY-

(Airport) AWOS/ASOS WEATHER AVAILABLE ON (frequency).

1. ASOS/AWOS shall be set to provide one minute weather at uncontrolled airports that are without ground-to-air weather broadcast capability by a CWO, NWS or FSS observer.

2. Controllers will consider the long-line disseminated weather from an automated weather system at an uncontrolled airport as trend information only and shall rely on the pilot for the current weather information for that airport.

3. Controllers shall issue the last long-line disseminated weather to the pilot if the pilot is unable to receive the ASOS/AWOS broadcast.

NOTE-

Aircraft destined to uncontrolled airports, which have automated weather data with broadcast capability, should monitor the ASOS/AWOS frequency to ascertain the current weather at the airport. The pilot should advise the controller when he/she has received the broadcast weather and state his/her intentions.

c. Issue any known changes classified as special weather observations as soon as possible. Special weather observations need not be issued after they are included in the ATIS broadcast and the pilot states the appropriate ATIS code.

d. Advise pilots when the ILS/MLS on the runway in use is not operational if that ILS/MLS is on the same frequency as an operational ILS/MLS serving another runway.

EXAMPLE-

“Expect visual approach runway two five right, runway two five right I-L-S not operational.”

REFERENCE-

FAAO 7110.65, Altimeter Setting Issuance Below Lowest Usable FL, Para 2-7-2

FAAO 7110.65, Approach Information, Para 5-10-2

14 CFR Section 91.129 Operations in Class D Airspace, Subpara (d)(2).

e. **TERMINAL:** If multiple runway transitions are depicted on a STAR procedure, advise pilots of the runway assignment on initial contact or as soon as possible thereafter.

4-7-11. ARRIVAL INFORMATION BY APPROACH CONTROL FACILITIES

TERMINAL

a. Forward the following information to nonapproach control towers soon enough to permit adjustment of the traffic flow or to FSSs soon enough to provide local airport advisory where applicable:

1. Aircraft identification.
2. Type of aircraft.
3. ETA.
4. Type of instrument approach procedure the aircraft will execute; or
5. For SVFR, the direction from which the aircraft will enter Class B, Class C, Class D, or Class E surface area and any altitude restrictions that were issued; or
6. For aircraft executing a contact approach, the position of the aircraft.

NOTE-

Specific time requirements are usually stated in a letter of agreement.

b. Forward the following information to the tower when the tower and TRACON are part of the same facility:

1. Aircraft identification.
2. Type aircraft if required for separation purposes.
3. Type of instrument approach procedure and/or runway if differing from that in use.

NOTE-

The local controller has the responsibility to determine whether or not conditions are adequate for the use of ATTS data on the CTRD where a facility directive authorizes its use for the transfer of arrival data.

REFERENCE-

*FAAO 7210.3, Use of Modify and Quick Look Functions, Para 11-2-4.
FAAO 7210.3, Use of STARS Quick Look Functions, Para 11-8-4.*

c. Where the collocated or satellite tower has ATTS data displayed on its CTRD, the ATTS modify or quick look functions may be used to forward arrival data provided that a facility directive at the collocated tower or a letter of agreement with the satellite tower exists which outlines procedures for using ATTS for transferring this data.

d. Forward the following information to centers:

1. Where two or more instrument approach procedures are published for the airport, the particular procedure which an aircraft can expect or that it will be vectored toward the airport for a visual approach.
2. Highest altitude being used by the approach control facility at the holding fix.
3. Average time interval between successive approaches.
4. Arrival time of aircraft over the holding fix or, if control has been transferred to you before an aircraft has reached the fix, a statement or other indication acknowledging receipt of control responsibility.
5. Revised EFC if different by 10 minutes or more from that issued by the center.
6. Missed approaches if they affect center operations.
7. Information relating to an unreported or overdue aircraft.

4-7-12. AIRPORT CONDITIONS

a. *EN ROUTE.* Before issuing an approach clearance or en route descent, and subsequently as changes occur, inform an aircraft of any abnormal operation of approach and landing aids and of destination airport conditions that you know of which might restrict an approach or landing.

b. *TERMINAL.* On first contact or as soon as possible thereafter, and subsequently as changes occur, inform an aircraft of any abnormal operation of approach and landing aids and of destination airport conditions that you know of which might restrict an approach or landing. This information may be omitted if it is contained in the ATIS broadcast and the pilot states the appropriate ATIS code.

REFERENCE-

FAAO 7110.65, Chapter 3, Section 3, Airport Conditions.

c. *TERMINAL.* Where RCRs are provided, transmit this information to USAF and ANG aircraft in accordance with one of the following. Issue the RCR to other aircraft upon pilot request.

1. Before or when an approach clearance is issued.
2. Before an en route descent clearance is issued.

3. Prior to departure.

4. As soon as possible after receipt of any subsequent changes in previously issued RCR information.

NOTE-

1. USAF has established RCR procedures for determining the average deceleration readings of runways under conditions of water, slush, ice, or snow. The use of RCR code is dependent upon the pilot having a "stopping capability chart" specifically applicable to his/her aircraft.

2. USAF offices furnish RCR information at airports serving USAF and ANG aircraft.

REFERENCE-

FAAO 7110.65, Landing Area Condition, Para 3-3-1

4-7-13. SWITCHING ILS/MLS RUNWAYS

TERMINAL

When a change is made from one ILS to another or from one MLS to another at airports equipped with multiple systems which are not used simultaneously, coordinate with the facilities which use the fixes formed by reference to these NAVAIDS.

Section 8. Approach Clearance Procedures

4-8-1. APPROACH CLEARANCE

a. Clear aircraft for “standard” or “special” instrument approach procedures only. To require an aircraft to execute a particular instrument approach procedure, specify in the approach clearance the name of the approach as published on the approach chart. Where more than one procedure is published on a single chart and a specific procedure is to be flown, amend the approach clearance to specify execution of the specific approach to be flown. If only one instrument approach of a particular type is published, the approach needs not be identified by the runway reference. An aircraft conducting an ILS/MLS approach when the glideslope/glidepath is reported out of service shall be advised at the time an approach clearance is issued. Standard Instrument Approach Procedures shall commence at an Initial Approach Fix or an Intermediate Approach Fix if there is not an Initial Approach Fix. Where adequate radar coverage exists, radar facilities may vector aircraft to the final approach course in accordance with para 5-9-1, Vectors to Final Approach Course.

PHRASEOLOGY-

CLEARED (type) **APPROACH.**

(For a straight-in-approach- IFR),

CLEARED STRAIGHT-IN (type) **APPROACH.**

(To authorize a pilot to execute his/her choice of instrument approach),

CLEARED APPROACH.

(Where more than one procedure is published on a single chart and a specific procedure is to be flown),

CLEARED (specific procedure to be flown) **APPROACH.**

(To authorize a pilot to execute an ILS/MLS approach when the glideslope/glidepath is out of service),

CLEARED (type) **APPROACH, GLIDESLOPE/ GLIDEPATH UNUSABLE.**

EXAMPLE-

“Cleared Approach.”

“Cleared V-O-R Approach.”

“Cleared V-O-R Runway Three Six Approach.”

“Cleared F-M-S Approach.”

“Cleared F-M-S Runway Three Six Approach.”

“Cleared I-L-S Approach.”

“Cleared Localizer Back Course Runway One Three Approach.”

“Cleared R-NAV Runway Two Two Approach.”

“Cleared GPS Runway Two Approach.”

“Cleared BRANCH ONE R-NAV Arrival and R-NAV Runway One Three Approach.”

“Cleared I-L-S Runway Three Six Approach, glideslope unusable.”

“Cleared M-L-S Approach.”

“Cleared M-L-S Runway Three Six Approach.”

“Cleared M-L-S Runway Three Six Approach, glidepath unusable.”

NOTE-

1. Clearances authorizing instrument approaches are issued on the basis that, if visual contact with the ground is made before the approach is completed, the entire approach procedure will be followed unless the pilot receives approval for a contact approach, is cleared for a visual approach, or cancels their IFR flight plan.

2. Approach clearances are issued based on known traffic. The receipt of an approach clearance does not relieve the pilot of his/her responsibility to comply with applicable Parts of Title 14 of the Code of Federal Regulations and the notations on instrument approach charts which levy on the pilot the responsibility to comply with or act on an instruction; e.g., “Straight-in minima not authorized at night,” “Procedure not authorized when glideslope/glidepath not used,” “Use of procedure limited to aircraft authorized to use airport,” or “Procedure not authorized at night.”

3. The name of the approach, as published, is used to identify the approach, even though a component of the approach aid, other than the localizer on an ILS or the azimuth on an MLS is inoperative. Where more than one procedure to the same runway is published on a single chart, each must adhere to all final approach guidance contained on that chart, even though each procedure will be treated as a separate entity when authorized by ATC. For example, Instrument Approach Procedures published on a chart as either HI-VOR/DME or TACAN 1 would be stated as either “HI V-O-R/ D-M-E 1 Runway Six Left Approach” or “HI TACAN 1 Runway Six Left Approach.” The use of numerical identifiers in the approach name, or alphabetical identifiers with a letter from the end of the alphabet; e.g., X, Y, Z, such as “HI TACAN 1 Rwy 6L or HI TACAN 2 Rwy 6L,” or “RNAV (GPS) Z Rwy 04 or RNAV (GPS) Y Rwy 04,” denotes multiple straight-in approaches to the same runway that use the same approach aid.

Alphabetical suffixes with a letter from the beginning of the alphabet; e.g., A, B, C, denote a procedure that does not meet the criteria for straight-in landing minimums authorization.

4. 14 CFR Section 91.175(j) requires a pilot to receive a clearance for a procedure turn when vectored to a final approach fix or position, conducting a timed approach, or when the procedure specifies "NO PT."

5. An aircraft which has been cleared to a holding fix and prior to reaching that fix is issued a clearance for an approach, but not issued a revised routing; i.e., "proceed direct to. . ." may be expected to proceed via the last assigned route, a feeder route (if one is published on the approach chart), and then to commence the approach as published. If, by following the route of flight to the holding fix, the aircraft would overfly an IAF or the fix associated with the beginning of a feeder route to be used, the aircraft is expected to commence the approach using the published feeder route to the IAF or from the IAF as appropriate; i.e., the aircraft would not be expected to overfly and return to the IAF or feeder route.

6. Approach name items contained within parenthesis; e.g., RNAV (GPS) Rwy 04, are not included in approach clearance phraseology.

REFERENCE-

FAAO 8260.3, United States Standard for Terminal Instrument Procedures (TERPS).

b. For aircraft operating on unpublished routes, issue the approach clearance only after the aircraft is: (See FIG 4-8-1.)

1. Established on a segment of a published route or instrument approach procedure.

EXAMPLE-

Aircraft 1: The aircraft is established on a segment of a published route at 5,000 feet. "Cleared V-O-R Runway Three Four Approach."

2. Assigned an altitude to maintain until the aircraft is established on a segment of a published route or instrument approach procedure.

EXAMPLE-

Aircraft 2: The aircraft is inbound to the VOR on an unpublished direct route at 7,000 feet. The minimum IFR altitude for IFR operations (14 CFR Section 91.177) along this flight path to the VOR is 5,000 feet. "Cross the Redding V-O-Rat or above five thousand, cleared V-O-R Runway Three Four Approach."

NOTE-

1. The altitude assigned must assure IFR obstruction clearance from the point at which the approach clearance is issued until established on a segment of a published route or instrument approach procedure.

2. If the altitude assignment is VFR-on-top, it is conceivable that the pilot may elect to remain high until arrival over the final approach fix which may require the pilot to circle to descend so as to cross the final approach fix at an altitude that would permit landing.

3. Established on a heading or course that will intercept the initial segment at the initial approach fix, or intermediate segment at the intermediate fix when no initial approach fix is published, for a GPS or RNAV instrument approach procedure at an angle not greater than 90 degrees. Angles greater than 90 degrees may be used when a hold in lieu of procedure turn pattern is depicted at the fix for the instrument approach procedure. (See FIG 4-8-2.)

FIG 4-8-1
Approach Clearance Example

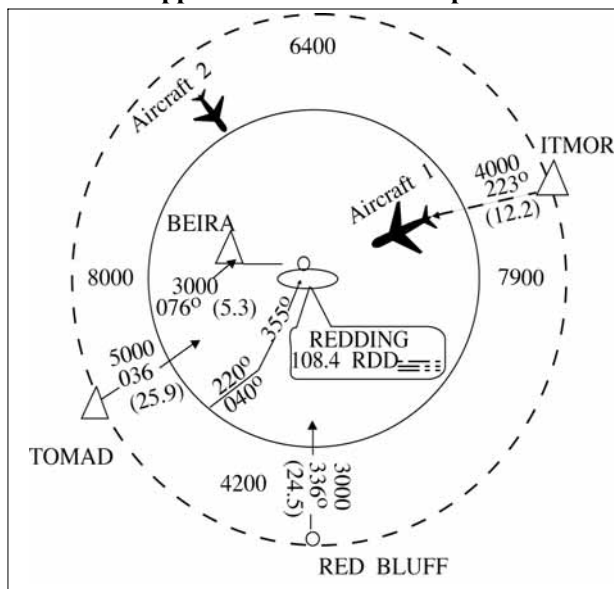
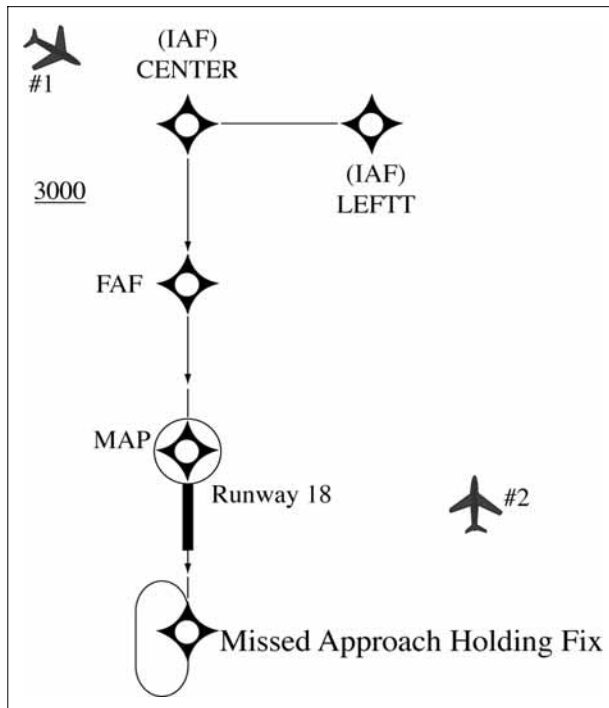

FIG 4-8-2

Approach Clearance Example For RNAV Aircraft



EXAMPLE-

Aircraft 1 can be cleared direct to CENTR. The intercept angle at that IAF is 90 degrees or less. The minimum altitude for IFR operations (14 CFR Section 91.177) along the flight path to the IAF is 3,000 feet. “Cleared direct CENTR, maintain at or above three thousand until CENTR, cleared R-NAV Runway One Eight approach.”

Aircraft 2 cannot be cleared direct to CENTR. The intercept angle is greater than 90 degrees and there is no hold in lieu of procedure turn pattern depicted. Aircraft 2 can be cleared direct to LEFTT. The intercept angle at that IAF is 90 degrees or less. The minimum altitude for IFR operations (14 CFR Section 91.177) along the flight path to the IAF is 3,000 feet. “Cleared direct LEFTT, maintain at or above three thousand until LEFTT, cleared R-NAV Runway One Eight approach.”

c. Except when applying radar procedures, timed or visual approaches, clear an aircraft for an approach to an airport when the preceding aircraft has landed or canceled IFR flight plan.

d. Where instrument approaches require radar monitoring and radar services are not available, do not use the phraseology “cleared approach,” which allows the pilot his/her choice of instrument approaches.

e. Where a Terminal Arrival Area (TAA) has been established to support RNAV approaches use the procedures under subpara b1 and b2 above. (See FIG 4-8-3.)

EXAMPLE-

Aircraft 1: The aircraft has crossed the TAA boundary and is established on a segment of the approach. “Cleared R-NAV Runway One Eight Approach.”

Aircraft 2: The aircraft is inbound to the CHARR (right corner) IAF on an unpublished direct route at 7,000 feet. The minimum IFR altitude for IFR operations (14 CFR Section 91.177) along this flight path to the IAF is 5,000 feet. “Cleared to CHARR, Maintain at or above five thousand until entering the TAA, Cleared R-NAV Runway One Eight Approach.”

f. For GPS UNRELIABLE NOTAMs, inform pilots requesting a GPS or RNAV approach that GPS is unreliable and clear the aircraft for the approach. This advisory may be omitted if contained in the Automated Terminal Information System (ATIS) broadcast.

g. For pilot reported GPS anomalies, advise subsequent aircraft requesting a GPS or RNAV approach that GPS is unreliable and clear the aircraft for the approach. This advisory may be discontinued after 15 minutes if no subsequent reports are received.

REFERENCE-

FAAO 7110.65, NAVAID Malfunction, Para 2-1-10.
FAAO 7110.65, Airport Conditions, Para 4-7-12.

PHRASEOLOGY-

CLEARED (approach), GPS UNRELIABLE.

h. For Wide Area Augmentation System (WAAS) UNAVAILABLE NOTAMs, advise aircraft requesting a GPS or RNAV approach that WAAS is unavailable and clear the aircraft for the approach. This advisory may be omitted if contained in the ATIS broadcast.

PHRASEOLOGY-

CLEARED (approach), WAAS UNAVAILABLE.

NOTE-

1. WAAS UNAVAILABLE NOTAMs indicate a failure of a WAAS system component. GPS/WAAS equipment reverts to GPS-only operation and satisfies the requirements for basic GPS equipment.

2. WAAS UNRELIABLE NOTAMs indicate predictive coverage, are published for pilot preflight planning, and do not require any controller action.

FIG 4-8-3

Basic "T" and TAA Design

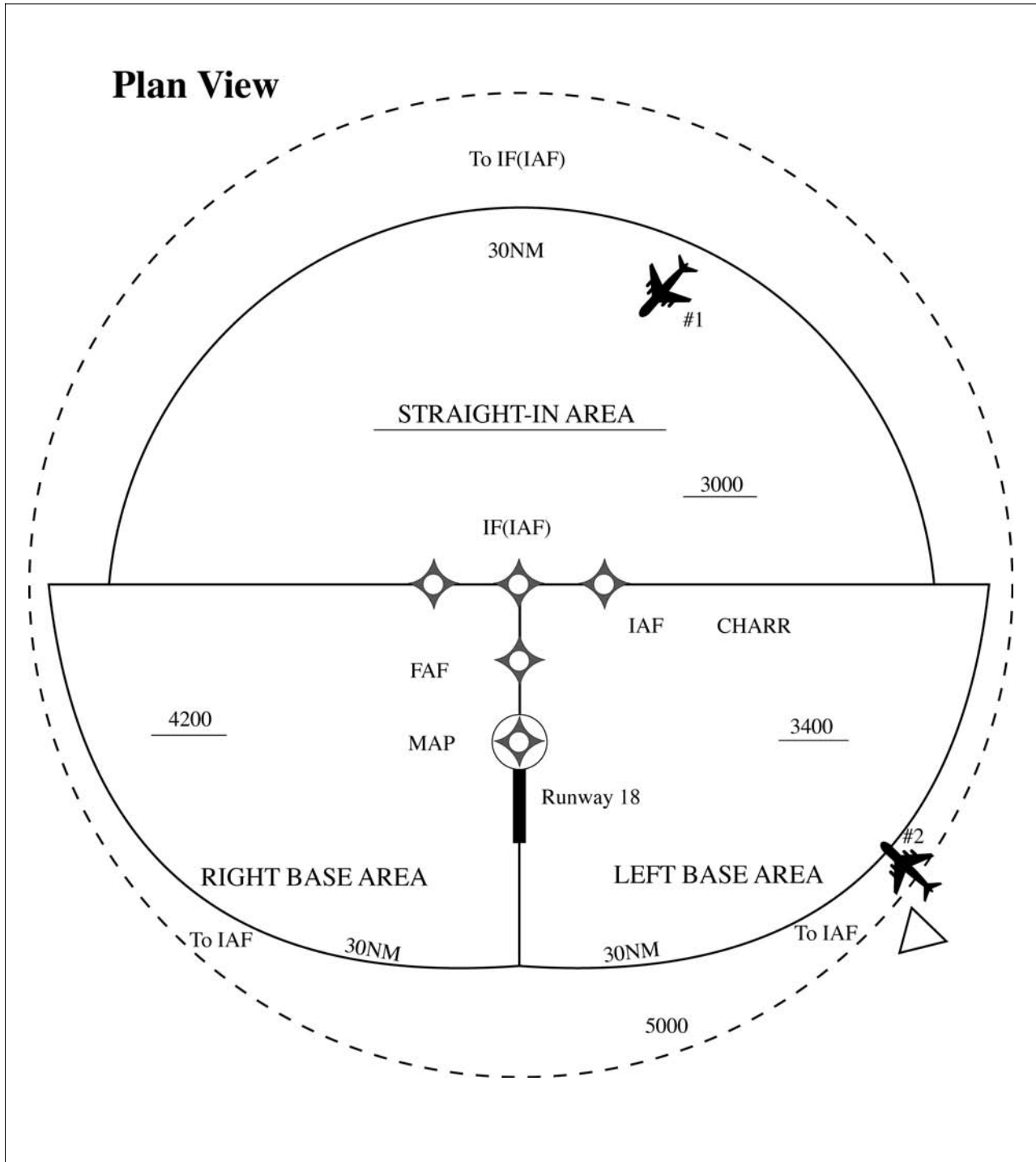

4-8-2. CLEARANCE LIMIT

Issue approach or other clearances, as required, specifying the destination airport as the clearance limit if airport traffic control service is not provided even though this is a repetition of the initial clearance.

4-8-3. RELAYED APPROACH CLEARANCE*TERMINAL*

Include the weather report, when it is required and available, when an approach clearance is relayed through a communication station other than an air carrier company radio. You may do this by telling the station to issue current weather.

4-8-4. ALTITUDE ASSIGNMENT FOR MILITARY HIGH ALTITUDE INSTRUMENT APPROACHES

Altitudes above those shown on the high altitude instrument approach procedures chart may be specified when required for separation.

NOTE-

To preclude the possibility of aircraft exceeding rate-of-descent or airspeed limitations, the maximum altitudes which may be assigned for any portion of the high altitude instrument approach procedure will be determined through coordination between the ATC facility concerned and the military authority which originated the high altitude instrument approach procedure.

REFERENCE-

FAAO 7110.65, Military Turbojet En Route Descent, Para 4-7-5

4-8-5. SPECIFYING ALTITUDE

Specify in the approach clearance the altitude shown in the approach procedures when adherence to that altitude is required for separation. When vertical separation will be provided from other aircraft by pilot adherence to the prescribed maximum, minimum, or mandatory altitudes, the controller may omit specifying the altitude in the approach clearance.

NOTE-

Use FAA or NIMA instrument approach procedures charts appropriate for the aircraft executing the approach.

4-8-6. CIRCLING APPROACH

a. Circling approach instructions may only be given for aircraft landing at airports with operational control towers.

b. Include in the approach clearance instructions to circle to the runway in use if landing will be made on a runway other than that aligned with the direction of instrument approach. When the direction of the circling maneuver in relation to the airport/runway is required, state the direction (eight cardinal compass points) and specify a left or right base/downwind leg as appropriate.

PHRASEOLOGY-

CIRCLE TO RUNWAY (number),

or

CIRCLE (direction using eight cardinal compass points) OF THE AIRPORT/RUNWAY FOR A LEFT/RIGHT BASE/DOWNWIND TO RUNWAY (number).

NOTE-

Where standard instrument approach procedures (SIAPs) authorize circling approaches, they provide a basic minimum of 300 feet of obstacle clearance at the MDA within the circling area considered. The dimensions of these areas, expressed in distances from the runways, vary for the different approach categories of aircraft. In some cases a SIAP may otherwise restrict circling approach maneuvers.

c. Do not issue clearances, such as “extend downwind leg,” which might cause an aircraft to exceed the circling approach area distance from the runways within which required circling approach obstacle clearance is assured.

4-8-7. SIDE-STEP MANEUVER*TERMINAL*

Side-Step Maneuver. When authorized by an instrument approach procedure, you may clear an aircraft for an approach to one runway and inform the aircraft that landing will be made on a parallel runway.

EXAMPLE-

“Cleared I-L-S Runway seven left approach. Side-step to runway seven right.”

NOTE-

Side-step maneuvers require higher weather minima/MDA. These higher minima/MDA are published on the instrument approach charts.

REFERENCE-

*FAAO 7110.65, Closed/Unsafe Runway Information, Para 3-3-2
P/CG Term- Sidestep Maneuver.*

4-8-8. COMMUNICATIONS RELEASE

If an IFR aircraft intends to land at an airport not served by a tower or FSS, approve a change to the advisory service frequency when you no longer require direct communications.

PHRASEOLOGY-
CHANGE TO ADVISORY FREQUENCY APPROVED.

NOTE-
An expeditious frequency change permits the aircraft to receive timely local airport traffic information in accordance with AC 90-42, Traffic Advisory Practices at Airports Without Operating Control Towers.

4-8-9. MISSED APPROACH

Except in the case of a VFR aircraft practicing an instrument approach, an approach clearance automatically authorizes the aircraft to execute the missed approach procedure depicted for the instrument approach being flown. An alternate missed approach procedure as published on the appropriate FAA Form 8260 or appropriate military form may be assigned when necessary. Once an aircraft commences a missed approach, it may be radar vectored.

NOTE-
1. *Alternate missed approach procedures are published on the appropriate FAA Form 8260 or appropriate military form and require a detailed clearance when they are issued to the pilot.*

2. *In the event of a missed approach involving a turn, unless otherwise cleared, the pilot will proceed to the missed approach point before starting that turn.*

REFERENCE-
FAAO 7110.65, Practice Approaches, Para 4-8-1.
FAAO 7110.65, Vectors Below Minimum Altitude, Para 5-6-3
FAAO 7110.65, Successive or Simultaneous Departures, Para 5-8-3
FAAO 8260.19, Flight Procedures and Airspace, Paras 404 and 815.
FAAO 8260.3, United States Standard for Terminal Instrument Procedures (TERPS), Paras 275, 278, 943, 957, and 997.

4-8-10. APPROACH INFORMATION

Specify the following in the approach clearance when the pilot says he/she is unfamiliar with the procedure:

- a. Initial approach altitude.
- b. Direction and distance from the holding fix within which procedure turn is to be completed.
- c. Altitude at which the procedure turn is to be made.
- d. Final approach course and altitude.

- e. Missed approach procedures if considered necessary.

PHRASEOLOGY-
INITIAL APPROACH AT (altitude), PROCEDURE TURN AT (altitude), (number) MINUTES/MILES (direction), FINAL APPROACH ON (name of NAVAID) (specified) COURSE/RADIAL/AZIMUTH AT (altitude).

4-8-11. PRACTICE APPROACHES

Except for military aircraft operating at military airfields, ensure that neither VFR nor IFR practice approaches disrupt the flow of other arriving and departing IFR or VFR aircraft. Authorize, withdraw authorization, or refuse to authorize practice approaches as traffic conditions require. Normally, approaches in progress should not be terminated.

NOTE-
The priority afforded other aircraft over practice instrument approaches is not intended to be so rigidly applied that it causes grossly inefficient application of services.

- a. Separation.

1. IFR aircraft practicing instrument approaches shall be afforded standard separation in accordance with Chapter 3, Chapter 4, Chapter 5, Chapter 6, and Chapter 7 minima until:

- (a) The aircraft lands, and the flight is terminated, or
- (b) The pilot cancels the flight plan.

2. Where procedures require application of IFR separation to VFR aircraft practicing instrument approaches, standard IFR separation in accordance with Chapter 3, Chapter 4, Chapter 5, Chapter 6, and Chapter 7 shall be provided. Controller responsibility for separation begins at the point where the approach clearance becomes effective. Except for heavy aircraft/B757, 500 feet vertical separation may be applied between VFR aircraft and between a VFR and an IFR aircraft.

REFERENCE-
FAAO 7210.3, Practice Instrument Approaches, Para 6-4-4.
FAAO 7210.3, Practice Instrument Approaches, Para 10-4-5.

3. Where separation services are not provided to VFR aircraft practicing instrument approaches, the controller shall;

- (a) Instruct the pilot to maintain VFR.
- (b) Advise the pilot that separation services are not provided.

PHRASEOLOGY–

“(Aircraft identification) MAINTAIN VFR, PRACTICE APPROACH APPROVED, NO SEPARATION SERVICES PROVIDED.”

(c) Provide traffic information or advise the pilot to contact the appropriate facility.

4. If an altitude is assigned, including at or above/below altitudes, the altitude specified must meet MVA, minimum safe altitude, or minimum IFR altitude criteria.

REFERENCE–

FAAO 7110.65, Altitude Assignments, Para 7–7–5

5. All VFR aircraft shall be instructed to maintain VFR on initial contact or as soon as possible thereafter.

NOTE–

This advisory is intended to remind the pilot that even though ATC is providing IFR-type instructions, the pilot is responsible for compliance with the applicable parts of the CFR governing VFR flight.

b. Missed Approaches.

1. Unless alternate instructions have been issued, IFR aircraft are automatically authorized to execute the missed approach depicted for the instrument approach being flown.

REFERENCE–

FAAO 7110.65, Missed Approach, Para 4–8–9

2. VFR aircraft are not automatically authorized to execute the missed approach procedure. This

authorization must be specifically requested by the pilot and approved by the controller. When a missed approach has been approved, separation shall be provided throughout the missed approach.

REFERENCE–

FAAO 7110.65, Visual Separation, Para 7–2–1

4–8–12. LOW APPROACH AND TOUCH-AND-GO

Consider an aircraft cleared for a touch-and-go, low approach, or practice approach as an arriving aircraft until that aircraft touches down or crosses the landing threshold; thereafter, consider the aircraft as a departing aircraft. Before the aircraft begins its final descent, issue the appropriate departure instructions the pilot is to follow upon completion of the approach (in accordance with para 4–3–2, Departure Clearances). Climb-out instructions must include a specific heading or a route of flight and altitude, except when the aircraft will maintain VFR and contact the tower.

EXAMPLE–

“After completing low approach, climb and maintain six thousand. Turn right, heading three six zero.”

“Maintain VFR, contact tower.”

(Issue other instructions as appropriate.)

NOTE–

Climb-out instructions may be omitted after the first approach if instructions remain the same.

Chapter 5. Radar

Section 1. General

5-1-1. PRESENTATION AND EQUIPMENT PERFORMANCE

Provide radar service only if you are personally satisfied that the radar presentation and equipment performance is adequate for the service being provided.

NOTE-

The provision of radar service is not limited to the distance and altitude parameters obtained during the commissioning flight check.

5-1-2. ALIGNMENT ACCURACY CHECK

During relief briefing, or as soon as possible after assuming responsibility for a control position, check the operating equipment for alignment accuracy and display acceptability. Recheck periodically throughout the watch.

REFERENCE-

*FAAO 7210.3, Chapter 3, Chapter 8, Chapter 9, Chapter 10, and Chapter 11.
Comparable Military Directives.*

TERMINAL

a. Check the alignment of the radar video display by assuring that the video/digital map or overlay is properly aligned with a permanent target of known range and azimuth on the radar display. Where possible, check one permanent target per quadrant.

b. Accuracy of the radar video display shall be verified for digitized radar systems by using the moving target indicator (MTI) reflectors, fixed location beacon transponders (Parrots), beacon real-time quality control (RTQC) symbols or calibration performance monitor equipment (CPME) beacon targets.

REFERENCE-

FAAO 7210.3, Tolerance for Radar Fix Accuracy, Para 3-8-1.

c. STARS equipment conducts continuous self-monitoring of alignment accuracy; therefore, controller alignment checks are not required.

EN ROUTE

d. Radar Data Processing (RDP) alignment checking is accomplished by the operational program as part of the certification procedures for system startup and then on a real-time basis during operational hours.

e. Ensure the situation display center and altitude limits for the system are appropriate for the operating position.

REFERENCE-

FAAO 7110.65, Selected Altitude Limits, Para 5-14-5

MEARTS

f. The operational program accomplishes alignment checking. Verification of accuracy shall be accomplished through the use of “targets of opportunity” over displayed fixes, navigational aids, etc., in accordance with provisions of FAAO 7210.3, para 8-3-1, Digital Map Verification.

5-1-3. RADAR USE

Use radar information derived from primary and secondary radar systems.

REFERENCE-

*FAAO 7110.65, Beacon Range Accuracy, Para 5-1-4
FAAO 7110.65, Inoperative or Malfunctioning Interrogator,
Para 5-2-15*

a. Secondary radar may be used as the sole display source as follows:

1. In Class A airspace.

REFERENCE-

*FAAO 7110.65, Failed Transponder in Class A Airspace, Para 5-2-16
14 CFR Section 91.135, Operations in Class A Airspace.*

2. Outside Class A airspace, or where mix of Class A airspace/non-Class A airspace exists, only when:

(a) Additional coverage is provided by secondary radar beyond that of the primary radar.

(b) The primary radar is temporarily unusable or out of service. Advise pilots when these conditions exist.

PHRASEOLOGY-

PRIMARY RADAR OUT OF SERVICE. RADAR TRAFFIC ADVISORIES AVAILABLE ON TRANSPONDER AIRCRAFT ONLY.

NOTE–

1. *Advisory may be omitted when provided on ATIS and pilot indicates having ATIS information.*

2. *Advisory may be omitted when there is overlapping primary radar coverage from multiple radar sites.*

(c) A secondary radar system is the only source of radar data for the area of service. When the system is used for separation, beacon range accuracy is assured, as provided in para 5-1-4, Beacon Range Accuracy.

NOTE–

1. *This provision is to authorize secondary radar only operations where there is no primary radar available and the condition is temporary.*

2. *Since Terminal facilities use Long Range Radar, this is applicable to En Route and Terminal Radar Facilities.*

b. **TERMINAL.** Do not use secondary radar to conduct surveillance (ASR) final approaches unless the system is fully digitized, or an emergency exists and the pilot concurs.

5-1-4. BEACON RANGE ACCURACY

a. You may use beacon targets for separation purposes if beacon range accuracy is verified by one of the following methods:

NOTE–

1. *The check for verification of beacon range accuracy accomplished by correlation of beacon and primary radar targets of the same aircraft is not a check of display accuracy. Therefore, it is not necessary that it be done using the same display with which separation is being provided, nor the same targets being separated.*

2. *Narrowband: Beacon range accuracy for automated narrowband display equipment is verified by AF personnel. Consequently, further verification by the controller is unnecessary.*

1. Correlate beacon and primary targets of the same aircraft (not necessarily the one being provided separation) to assure that they coincide.

2. When beacon and primary targets of the same aircraft do not coincide, correlate them to assure that any beacon displacement agrees with the specified distance and direction for that particular radar system.

3. Refer to beacon range monitoring equipment where so installed.

b. If beacon range accuracy cannot be verified, you may use beacon targets only for traffic information.

REFERENCE–

FAAO 7110.65, Radar Use, Para 5-1-3

5-1-5. ELECTRONIC ATTACK (EA) ACTIVITY

a. Refer all EA activity requests to the appropriate center supervisor.

REFERENCE–

FAAO 7610.4, Chapter 2, Section 7, Electronic Attack (EA) Missions/Exercises.

NOTE–

EA activity can subsequently result in a request to apply EA videos to the radar system which may necessitate the decertification of the narrowband search radar. The Systems Engineer should be consulted concerning the effect of EA on the operational use of the narrowband radar prior to approving/disapproving requests to conduct EA activity.

b. When EA activity interferes with the operational use of radar:

1. **EN ROUTE.** Request the responsible military unit or aircraft, if initial request was received directly from pilot, to suspend the activity.

2. **TERMINAL.** Request suspension of the activity through the ARTCC. If immediate cessation of the activity is required, broadcast the request directly to the EA aircraft on the emergency frequency. Notify the ARTCC of direct broadcast as soon as possible.

c. When previously suspended activity will no longer interfere:

1. **EN ROUTE.** Inform the NORAD unit or aircraft that it may be resumed.

2. **TERMINAL.** Inform the ARTCC or aircraft that it may be resumed. Obtain approval from the ARTCC prior to broadcasting a resume clearance directly to the aircraft.

d. In each stop request, include your facility name, type of EA activity (chaff dispensing– “stream”/ “burst” or electronic jamming– “buzzer”), radar band affected and, when feasible, expected duration of suspension.

PHRASEOLOGY–

BIG PHOTO (identification, if known) (name)
CENTER/TOWER/APPROACH CONTROL.

To stop EA activity:

STOP STREAM/BURST IN AREA (area name) (degree and distance from facility),

or

STOP BUZZER ON (frequency band or channel).

To resume EA activity:

RESUME STREAM/BURST,

or

RESUME BUZZER ON (frequency band or channel).

5-1-6. SERVICE LIMITATIONS

a. When radar mapping is not available, limit radar services to:

1. Separating identified aircraft targets.
2. Vectoring aircraft to intercept a PAR final approach course.
3. Providing radar service in areas that ensure no conflict with traffic on airways, other ATC areas of jurisdiction, restricted or prohibited areas, terrain, etc.

b. **EN ROUTE.** When the position symbol associated with the full data block falls more than one history behind the actual aircraft target or there is no target symbol displayed, the Mode C information in the full data block shall not be used for the purpose of determining separation.

c. Report radar malfunctions immediately for corrective action and for dispatch of a Notice to Airmen. Advise adjacent ATC facilities when appropriate.

REFERENCE–

FAAO 7110.65, *Reporting Essential Flight Information, Para 2-1-9*
FAAO 7210.3, *Chapter 3, Chapter 7, Chapter 10 Section 5, and Chapter 11 Section 2.*

5-1-7. ELECTRONIC CURSOR**TERMINAL**

a. An electronic cursor may be used to aid in identifying and vectoring an aircraft and to give finer delineation to a video map. Do not use it as a substitute for a video map or map overlay; e.g., to form intersections, airway boundaries, final approach courses, etc.

b. Fixed electronic cursors may be used to form the final approach course for surveillance approaches conducted by military operated mobile radar facilities.

5-1-8. MERGING TARGET PROCEDURES

a. Except while they are established in a holding pattern, apply merging target procedures to all radar identified:

1. Aircraft at 10,000 feet and above.
2. Turbojet aircraft regardless of altitude.

REFERENCE–

P/CG Term– Turbojet Aircraft.

3. Presidential aircraft regardless of altitude.

b. Issue traffic information to those aircraft listed in subpara a whose targets appear likely to merge unless the aircraft are separated by more than the appropriate vertical separation minima.

EXAMPLE–

“Traffic twelve o’clock, seven miles, eastbound, MD-80, at one seven thousand.”

“United Sixteen and American Twenty-five, traffic twelve o’clock, one zero miles, opposite direction, eastbound seven twenty seven at flight level three three zero, westbound MD-Eighty at flight level three one zero.”

c. When both aircraft in subpara b are in RVSM airspace, and vertically separated by 1,000 feet, if either pilot reports they are unable to maintain RVSM due to turbulence or mountain wave, vector either aircraft to avoid merging with the target of the other aircraft.

EXAMPLE–

“Delta One Twenty Three, fly heading two niner zero, vector for traffic. Traffic twelve o’clock, one zero miles, opposite direction, MD-80 eastbound at flight level three two zero.”

d. If the pilot requests, vector his/her aircraft to avoid merging with the target of previously issued traffic.

NOTE-

Aircraft closure rates are so rapid that when applying merging target procedures, controller issuance of traffic must be commenced in ample time for the pilot to decide if a vector is necessary.

- e.** If unable to provide vector service, inform the pilot.

NOTE-

The phraseology “Unable RVSM due turbulence (or mountain wave)” is only intended for severe turbulence or other weather encounters with altitude deviations of approximately 200 feet or more.

5-1-9. HOLDING PATTERN SURVEILLANCE

Provide radar surveillance of outer fix holding pattern airspace areas, or any portions thereof, shown on your radar scope (displayed on the video map or scribed on the map overlay) whenever aircraft are holding there. Attempt to detect any aircraft that stray outside the area. If you detect an aircraft straying outside the area, assist it to return to the assigned airspace.

5-1-10. DEVIATION ADVISORIES

Inform an aircraft when it is observed in a position and on a track which will obviously cause the aircraft to deviate from its protected airspace area. If necessary, assist the aircraft to return to the assigned protected airspace.

REFERENCE-

*FAAO 7110.65, Route or Altitude Amendments, Para 4-2-5
FAAO 7110.65, Methods, Para 7-9-3*

5-1-11. RADAR FIX POSTING**EN ROUTE**

A controller is required to manually record at least once the observed or reported time over a fix for each controlled aircraft in their sector of responsibility only when the flight progress recording components of the EAS FDP are not operational.

REFERENCE-

*FAAO 7210.3, Flight Progress Strip Usage, Para 6-1-6.
FAAO 7210.3, Flight Progress Strip Usage, Para 10-1-8.*

5-1-12. POSITION REPORTING

If necessary, you may request an aircraft to provide an estimate or report over a specific fix. After an aircraft receives the statement “radar contact” from ATC, it discontinues reporting over compulsory reporting points. It resumes normal position reporting when ATC informs it “radar contact lost” or “radar service terminated.”

REFERENCE-

P/CG Term- Radar Contact.

- a.** When required, inform an aircraft of its position with respect to a fix or airway.

PHRASEOLOGY-

OVER/PASSING (fix).

(Number of miles) MILES FROM (fix).

(Number of miles) MILES (direction) OF (fix, airway, or location).

CROSSING/JOINING/DEPARTING (airway or route).

*INTERCEPTING/CROSSING (name of NAVAID)
(specified) RADIAL.*

5-1-13. RADAR SERVICE TERMINATION

- a.** Inform aircraft when radar service is terminated.

PHRASEOLOGY-

RADAR SERVICE TERMINATED (nonradar routing if required).

- b.** Radar service is automatically terminated and the aircraft needs not be advised of termination when:

NOTE-

1. *Termination of radar monitoring when conducting simultaneous ILS/MLS approaches is prescribed in para 5-9-7 Simultaneous Independent ILS/MLS Approaches-Dual & Triple.*

2. *Termination of radar monitoring where PAR equipment is used to monitor approaches is prescribed in para 5-13-3 Monitor Information.*

1. An aircraft cancels its IFR flight plan, except within Class B airspace, Class C airspace, TRSA, or where basic radar service is provided.

2. An aircraft conducting an instrument, visual, or contact approach has landed or has been instructed to change to advisory frequency.

3. At tower-controlled airports where radar coverage does not exist to within $1/2$ mile of the end of the runway, arriving aircraft shall be informed when radar service is terminated.

REFERENCE-

FAAO 7210.3, Radar Tolerances, Para 10-5-6.

4. TERMINAL. An arriving VFR aircraft receiving radar service to a tower-controlled airport

within Class B airspace, Class C airspace, TRSA, or where basic radar service is provided has landed, or to all other airports, is instructed to change to tower or advisory frequency.

5. TERMINAL. An aircraft completes a radar approach.

REFERENCE-

FAAO 7110.65, Service Provided When Tower is Inoperative, Para 7-6-12

Section 2. Beacon Systems

5-2-1. ASSIGNMENT CRITERIA

a. General.

1. Mode 3/A is designated as the common military/civil mode for air traffic control use.

2. Make radar beacon code assignments to only Mode 3/A transponder-equipped aircraft.

b. Unless otherwise specified in a directive or a letter of agreement, make code assignments to departing, en route, and arrival aircraft in accordance with the procedures specified in this section for the radar beacon code environment in which you are providing ATC service. Give first preference to the use of discrete beacon codes.

PHRASEOLOGY-
SQUAWK THREE/ALFA (code),

or

SQUAWK (code).

NOTE-

A code environment is determined by an operating position's/sector's equipment capability to decode radar beacon targets using either the first and second or all four digits of a beacon code.

REFERENCE-

FAAO 7110.65, Beacon Identification Methods, Para 5-3-3

5-2-2. DISCRETE ENVIRONMENT

a. Issue discrete beacon codes assigned by the computer. Computer-assigned codes may be modified as required.

1. **TERMINAL.** Aircraft that will remain within the terminal facility's delegated airspace shall be assigned a code from the code subset allocated to the terminal facility.

2. **TERMINAL.** Unless otherwise specified in a facility directive or a letter of agreement, aircraft that will enter an adjacent ATTS facility's delegated airspace shall be assigned a beacon code assigned by the ARTCC computer.

NOTE-

1. *This will provide the adjacent facility advance information on the aircraft and will cause auto-acquisition of the aircraft prior to handoff.*

2. *When an IFR aircraft, or a VFR aircraft that has been assigned a beacon code by the host computer and whose flight plan will terminate in another facility's area, cancels ATC service or does not activate the flight plan, send a remove strips (RS) message on that aircraft via host keyboard, the FDIO keyboard, or call via service F.*

b. Make handoffs to other positions/sectors on the computer-assigned code.

c. Coastal facilities accepting "over" traffic that will subsequently be handed-off to an oceanic ARTCC shall reassign a new discrete beacon code to an aircraft when it first enters the receiving facility's airspace. The code reassignment shall be accomplished by inputting an appropriate message into the computer and issued to the pilot while operating in the first sector/position in the receiving facility's airspace.

NOTE-

Per an agreement between FAA and the Department of Defense, 17 Code subsets in the NBCAP have been reserved for exclusive military use outside NBCAP airspace. To maximize the use of these subsets, they have been allocated to ARTCC's underlying NBCAP airspace that do not abut an oceanic ARTCC's area. To preclude a potential situation where two aircraft might be in the same airspace at the same time on the same discrete code, it is necessary to reassign an aircraft another code as specified in subpara c.

REFERENCE-

FAAO 7110.65, Mixed Environment, Para 5-2-4

FAAO 7110.65, VFR Code Assignments, Para 5-2-9

FAAO 7110.65, Beacon Identification Methods, Para 5-3-3

5-2-3. NONDISCRETE ENVIRONMENT

a. Assign appropriate nondiscrete beacon codes from the function codes specified in para 5-2-6, Function Code Assignments.

b. Unless otherwise coordinated at the time of handoff, make handoffs to other positions/sectors on an appropriate nondiscrete function code.

REFERENCE-

FAAO 7110.65, Mixed Environment, Para 5-2-4

FAAO 7110.65, VFR Code Assignments, Para 5-2-9

FAAO 7110.65, Beacon Identification Methods, Para 5-3-3

5-2-4. MIXED ENVIRONMENT

a. When discrete beacon code capability does not exist in your area of responsibility, comply with the procedures specified in para 5-2-3, Nondiscrete Environment.

NOTE-

In a mixed code environment, a situation may exist where a discrete-equipped position/sector exchanges control of aircraft with nondiscrete-equipped facilities or vice versa.

b. When discrete beacon code capability exists in your area of responsibility:

1. Comply with the procedures specified in para 5-2-2, Discrete Environment, and

2. Unless otherwise coordinated at the time of handoff, assign aircraft that will enter the area of responsibility of a nondiscrete-equipped position/sector an appropriate nondiscrete function code from the codes specified in para 5-2-6, Function Code Assignments, prior to initiating a handoff.

REFERENCE-

FAAO 7110.65, IFR-VFR and VFR-IFR Flights, Para 4-2-8

FAAO 7110.65, VFR Code Assignments, Para 5-2-9

FAAO 7110.65, Beacon Identification Methods, Para 5-3-3

5-2-5. RADAR BEACON CODE CHANGES

Unless otherwise specified in a directive or a letter of agreement or coordinated at the time of handoff, do not request an aircraft to change from the code it was squawking in the transferring facility's area until the aircraft is within your area of responsibility.

REFERENCE-

FAAO 7110.65, IFR-VFR and VFR-IFR Flights, Para 4-2-8

FAAO 7110.65, Beacon Identification Methods, Para 5-3-3

5-2-6. FUNCTION CODE ASSIGNMENTS

Unless otherwise specified by a directive or a letter of agreement, make nondiscrete code assignments from the following categories:

a. Assign codes to departing IFR aircraft as follows:

1. Code 2000 to an aircraft which will climb to FL 240 or above or to an aircraft which will climb to FL 180 or above where the base of Class A airspace and the base of the operating sector are at FL 180, and for inter-facility handoff the receiving sector is also stratified at FL 180. The en route code shall not be assigned until the aircraft is established in the high altitude sector.

2. Code 1100 to an aircraft which will remain below FL 240 or below FL 180 as above.

3. For handoffs from terminal facilities when so specified in a letter of agreement as follows:

(a) Within NBCAP airspace- **Code 0100 to Code 0400** inclusive or any other code authorized by the regional air traffic division.

(b) Outside NBCAP airspace- **Code 1000** or one of the codes from **0100 to 0700** inclusive or any other code authorized by the regional air traffic division.

b. Assign codes to en route IFR aircraft as follows:

NOTE-

1. FL 180 may be used in lieu of FL 240 where the base of Class A airspace and the base of the operating sector are at FL 180, and for inter-facility handoff the receiving sector is also stratified at FL 180.

2. The provisions of subparas b2(b) and (c) may be modified by facility directive or letter of agreement when operational complexities or simplified sectorization indicate. Letters of agreement are mandatory when the operating sectors of two facilities are not stratified at identical levels. The general concept of utilizing Codes 2100 through 2500 within Class A airspace should be adhered to.

1. Aircraft operating below FL 240 or when control is transferred to a controller whose area includes the stratum involved.

(a) Code 1000 may be assigned to aircraft changing altitudes.

(b) Code 1100 to an aircraft operating at an assigned altitude below FL 240. Should an additional code be operationally desirable, **Code 1300** shall be assigned.

2. Aircraft operating at or above FL 240 or when control is transferred to a controller whose area includes the stratum involved.

(a) Code 2300 may be assigned to aircraft changing altitudes.

(b) Code 2100 to an aircraft operating at an assigned altitude from FL 240 to FL 330 inclusive. Should an additional code be operationally desirable, **Code 2200** shall be assigned.

(c) Code 2400 to an aircraft operating at an assigned altitude from FL 350 to FL 600 inclusive. Should an additional code be operationally desirable, **Code 2500** shall be assigned.

3. Code 4000 when aircraft are operating on a flight plan specifying frequent or rapid changes in assigned altitude in more than one stratum or other

conditions of flight not compatible with a stratified code assignment.

NOTE-

1. Categories of flight that can be assigned **Code 4000** include certain flight test aircraft, MTR missions, aerial refueling operation requiring descent involving more than one stratum, ALTRVs where continuous monitoring of ATC communications facilities is not required and frequent altitude changes are approved, and other aircraft operating on flight plans requiring special handling by ATC.

2. Military aircraft operating VFR or IFR in restricted/warning areas or VFR on VR routes will adjust their transponders to reply on **Code 4000** unless another code has been assigned by ATC or coordinated, if possible, with ATC.

c. Assign the following codes to arriving IFR aircraft, except military turbojet aircraft as specified in para 4-7-4, Radio Frequency and Radar Beacon Changes for Military Aircraft:

NOTE-

FL 180 may be used in lieu of FL 240 where the base of Class A airspace and the base of the operating sector are at FL 180, and for inter-facility handoff the receiving sector is also stratified at FL 180.

1. Code 2300 may be assigned for descents while above FL 240.

2. Code 1500 may be assigned for descents into and while within the strata below FL 240, or with prior coordination the specific code utilized by the destination controller, or the code currently assigned when descent clearance is issued.

3. The applicable en route code for the holding altitude if holding is necessary before entering the terminal area and the appropriate code in subparas 1 or 2.

REFERENCE-

FAAO 7110.65, IFR-VFR and VFR-IFR Flights, Para 4-2-8
FAAO 7110.65, Nondiscrete Environment, Para 5-2-3
FAAO 7110.65, Mixed Environment, Para 5-2-4
FAAO 7110.65, VFR Code Assignments, Para 5-2-9
FAAO 7110.65, Beacon Identification Methods, Para 5-3-3

5-2-7. EMERGENCY CODE ASSIGNMENT

Assign codes to emergency aircraft as follows:

a. Code 7700 when the pilot declares an emergency and the aircraft is not radar identified.

PHRASEOLOGY-

SQUAWK MAYDAY ON 7700.

b. After radio and radar contact have been established, you may request other than single-piloted helicopters and single-piloted turbojet aircraft to change from **Code 7700** to another code appropriate for your radar beacon code environment.

NOTE-

1. The code change, based on pilot concurrence, the nature of the emergency, and current flight conditions will signify to other radar facilities that the aircraft in distress is identified and under ATC control.

2. Pilots of single-piloted helicopters and single-piloted turbojet aircraft may be unable to reposition transponder controls during the emergency.

PHRASEOLOGY-

RADAR CONTACT (position). IF FEASIBLE, SQUAWK (code).

REFERENCE-

FAAO 7110.65, Beacon Identification Methods, Para 5-3-3

c. The following shall be accomplished on a Mode C equipped VFR aircraft which is in emergency but no longer requires the assignment of **Code 7700**:

1. TERMINAL. Assign a beacon code that will permit terminal minimum safe altitude warning (MSAW) alarm processing.

2. EN ROUTE. An appropriate keyboard entry shall be made to ensure en route MSAW (EMSAW) alarm processing.

5-2-8. RADIO FAILURE

When you observe a **Code 7600** display, apply the procedures in para 10-4-4, Communications Failure.

NOTE-

*Should a transponder-equipped aircraft experience a loss of two-way radio communications capability, the pilot can be expected to adjust his/her transponder to **Code 7600**.*

REFERENCE-

FAAO 7110.65, Beacon Identification Methods, Para 5-3-3

5-2-9. VFR CODE ASSIGNMENTS

a. For VFR aircraft receiving radar advisories, assign an appropriate function code or computer-assigned code for the code environment in which you are providing service.

NOTE-

1. Para 5-2-2 Discrete Environment; para 5-2-3 Nondiscrete Environment, and para 5-2-4 Mixed Environment, specify code assignment procedures to follow for the three code environments.

2. Para 5-2-6 Function Code Assignments, specifies the function code allocation from which an appropriate code for the aircraft indicated in subpara a should be selected. In the terminal environment, additional function codes may be authorized by the regional air traffic division.

1. If the aircraft is outside of your area of responsibility and an operational benefit will be gained by retaining the aircraft on your frequency for the purpose of providing services, ensure that coordination has been effected:

(a) As soon as possible after positive identification, and

(b) Prior to issuing a control instruction or providing a service other than a safety alert/traffic advisory.

NOTE-

Safety alerts/traffic advisories may be issued to an aircraft prior to coordination if an imminent situation may be averted by such action. Coordination should be effected as soon as possible thereafter.

b. Instruct IFR aircraft which cancel an IFR flight plan and are not requesting radar advisory service and VFR aircraft for which radar advisory service is being terminated to squawk the VFR code.

PHRASEOLOGY-
SQUAWK VFR.

or

SQUAWK 1200.

NOTE-

1. Aircraft not in contact with an ATC facility may squawk 1255 in lieu of 1200 while en route to/from or within the designated fire fighting area(s).

2. VFR aircraft which fly authorized SAR missions for the USAF or USCG may be advised to squawk 1277 in lieu of 1200 while en route to/from or within the designated search area.

REFERENCE-

FAAO 7110.66, National Beacon Code Allocation Plan.

c. When an aircraft changes from VFR to IFR, the controller shall assign a beacon code to Mode C equipped aircraft that will allow MSAW alarms.

REFERENCE-

FAAO 7110.65, Beacon Identification Methods, Para 5-3-3

5-2-10. BEACON CODE FOR PRESSURE SUIT FLIGHTS AND FLIGHTS ABOVE FL 600

a. Mode 3/A, **Code 4400**, and discrete **Codes 4401 through 4477** are reserved for use by R-71, F-12, U-2, B-57, pressure suit flights, and aircraft operations above FL 600.

NOTE-

The specific allocation of the special use codes in subset 4400 is in FAAO 7110.66, National Beacon Code Allocation Plan.

b. Ensure that aircraft remain on **Code 4400** or one of the special use discrete codes in the **4400** subset if filed as part of the flight plan. Except when unforeseen events, such as weather deviations, equipment failure, etc., cause more than one aircraft with same Mode 3/A discrete beacon codes to be in the same or adjacent ARTCC's airspace at the same time, a controller may request the pilot to make a code change, squawk standby, or to stop squawk as appropriate.

NOTE-

Due to the inaccessibility of certain equipment to the flight crews, **Code 4400** or a discrete code from the **4400** subset is preset on the ground and will be used throughout the flight profile including operations below FL 600. Controllers should be cognizant that not all aircraft may be able to accept the transponder changes identified in the exception. Emergency **Code 7700**, however, can be activated.

REFERENCE-

FAAO 7110.65, Beacon Identification Methods, Para 5-3-3

5-2-11. AIR DEFENSE EXERCISE BEACON CODE ASSIGNMENT

EN ROUTE

Ensure exercise FAKER aircraft remain on the exercise flight plan filed discrete beacon code.

NOTE-

1. NORAD will ensure exercise FAKER aircraft flight plans are filed containing discrete beacon codes from the Department of Defense code allocation specified in FAAO 7610.4, Special Military Operations, Appendix 8.

2. NORAD will ensure that those FAKER aircraft assigned the same discrete beacon code are not flight planned in the same or any adjacent ARTCC's airspace at the same time. (Simultaneous assignment of codes will only occur when operational requirements necessitate.)

REFERENCE-

FAAO 7110.65, Beacon Identification Methods, Para 5-3-3

5-2-12. STANDBY OR LOW SENSITIVITY OPERATION

You may instruct an aircraft operating on an assigned code to change transponder to “standby” or “low sensitivity” position:

NOTE-

National standards no longer require improved transponder to be equipped with the low sensitivity feature. Therefore, aircraft with late model transponders will be unable to respond to a request to “squawk low.”

a. When approximately 15 miles from its destination and you no longer desire operation of the transponder.

b. When necessary to reduce clutter in a multi-target area, or to reduce “ring-around” or other phenomena, provided you instruct the aircraft to return to “normal sensitivity” position as soon as possible thereafter.

PHRASEOLOGY-
SQUAWK STANDBY,

or

SQUAWK LOW/NORMAL.

REFERENCE-

FAAO 7110.65, *Beacon Identification Methods, Para 5-3-3*

5-2-13. CODE MONITOR

Continuously monitor the Mode 3/A radar beacon codes assigned for use by aircraft operating within your area of responsibility when nonautomated beacon decoding equipment (e.g., 10-channel decoder) is used to display the target symbol.

REFERENCE-

FAAO 7110.65, *Function Code Assignments, Para 5-2-6*

NOTE-

In addition to alphanumeric and control symbology processing enhancements, the MEARTS, STARS, and the TPX-42 systems are equipped with automatic beacon decoders. Therefore, in facilities where the automatic beacon decoders are providing the control slash video, there is no requirement to have the nonautomated decoding equipment operating simultaneously.

REFERENCE-

FAAO 7210.3, *Monitoring of Mode 3/A Radar Beacon Codes, Para 3-7-4.*

a. This includes the appropriate IFR code actually assigned and, additionally, **Code 1200, Code 1255,** and **Code 1277** unless your area of responsibility includes only Class A airspace. During periods when

ring-around or excessive VFR target presentations derogate the separation of IFR traffic, the monitoring of VFR **Code 1200, Code 1255, and Code 1277** may be temporarily discontinued.

b. Positions of operation which contain a restricted or warning area or VR route within or immediately adjacent to their area of jurisdiction shall monitor **Code 4000** and any other code used in lieu of **4000** within the warning/restricted area or VR route. If by local coordination with the restricted/warning area or VR route user a code other than 4000 is to be exclusively used, then this code shall be monitored.

c. If a normally assigned beacon code disappears, check for a response on the following codes in the order listed and take appropriate action:

NOTE-

When Codes 7500 and/or 7600 have been preselected, it will be necessary for the ID-SEL-OFF switches for these codes to be left in the off position so that beacon target for an aircraft changing to one of these codes will disappear, thereby alerting the controller to make the check. This check will not be required if automatic alerting capability exists.

1. Code 7500 (hijack code).

REFERENCE-

FAAO 7110.65, *Hijacked Aircraft, Para 10-2-6*

2. Code 7600 (loss of radio communications code).

5-2-14. FAILURE TO DISPLAY ASSIGNED BEACON CODE OR INOPERATIVE/MALFUNCTIONING TRANSPONDER

a. Inform an aircraft with an operable transponder that the assigned beacon code is not being displayed.

PHRASEOLOGY-

(Identification) RESET TRANSPONDER, SQUAWK (appropriate code).

b. Inform an aircraft when its transponder appears to be inoperative or malfunctioning.

PHRASEOLOGY-

(Identification) YOUR TRANSPONDER APPEARS INOPERATIVE/MALFUNCTIONING, RESET, SQUAWK (appropriate code).

c. Ensure that the subsequent control position in the facility or the next facility, as applicable, is notified when an aircraft transponder is malfunctioning/inoperative.

REFERENCE-

FAAO 7110.65, *Beacon Identification Methods, Para 5-3-3*

5-2-15. INOPERATIVE OR MALFUNCTIONING INTERROGATOR

Inform aircraft concerned when the ground interrogator appears to be inoperative or malfunctioning.

PHRASEOLOGY-

(Name of facility or control function) *BEACON INTERROGATOR INOPERATIVE/MALFUNCTIONING.*

REFERENCE-

FAAO 7110.65, *Radar Use, Para 5-1-3*

FAAO 7110.65, *Beacon Identification Methods, Para 5-3-3*

5-2-16. FAILED TRANSPONDER IN CLASS A AIRSPACE

Disapprove a request or withdraw previously issued approval to operate in Class A airspace with a failed transponder solely on the basis of traffic conditions or other operational factors.

REFERENCE-

FAAO 7110.65, *Radar Use, Para 5-1-3*

FAAO 7110.65, *Beacon Identification Methods, Para 5-3-3*

5-2-17. VALIDATION OF MODE C READOUT

Ensure that Mode C altitude readouts are valid after accepting an interfacility handoff, initial track start, track start from coast/suspend tabular list, missing, or unreasonable Mode C readouts. For TPX-42 and equivalent systems ensure that altitude readout is valid immediately after identification. (TCDD-/BANS-equipped tower cabs are not required to validate Mode C readouts after receiving interfacility handoffs from TRACONS according to the procedures in para 5-4-3, Methods, subpara a4.)

a. Consider an altitude readout valid when:

1. It varies less than 300 feet from the pilot reported altitude, or

PHRASEOLOGY-

(If aircraft is known to be operating below the lowest useable flight level),

SAY ALTITUDE.

or

(If aircraft is known to be operating at or above the lowest useable flight level),

SAY FLIGHT LEVEL.

2. You receive a continuous readout from an aircraft on the airport and the readout varies by less than 300 feet from the field elevation, or

NOTE-

A continuous readout exists only when the altitude filter limits are set to include the field elevation.

REFERENCE-

FAAO 7110.65, *Altitude Filters, Para 5-2-23*

FAAO 7110.65, *Selected Altitude Limits, Para 5-14-5*

FAAO 7210.3, *Display Data, Para 11-2-3.*

3. You have correlated the altitude information in your data block with the validated information in a data block generated in another facility (by verbally coordinating with the other controller) and your readout is exactly the same as the readout in the other data block.

b. When unable to validate the readout, do not use the Mode C altitude information for separation.

c. Whenever you observe an invalid Mode C readout below FL 180:

1. Issue the correct altimeter setting and confirm the pilot has accurately reported the altitude.

PHRASEOLOGY-

(Location) *ALTIMETER (appropriate altimeter), VERIFY ALTITUDE.*

2. If the altitude readout continues to be invalid:

(a) Instruct the pilot to turn off the altitude-reporting part of his/her transponder and include the reason; and

(b) Notify the operations supervisor-in-charge of the aircraft call sign.

PHRASEOLOGY-

STOP ALTITUDE SQUAWK. ALTITUDE DIFFERS BY (number of feet) FEET.

d. Whenever you observe an invalid Mode C readout at or above FL 180, unless the aircraft is descending below Class A airspace:

1. Confirm that the pilot is using 29.92 inches of mercury as the altimeter setting and has accurately reported the altitude.

PHRASEOLOGY-

CONFIRM USING TWO NINER NINER TWO AS YOUR ALTIMETER SETTING.

(If aircraft is known to be operating at or above the lowest useable flight level),

VERIFY FLIGHT LEVEL.

2. If the Mode C readout continues to be invalid:

(a) Instruct the pilot to turn off the altitude-reporting part of his/her transponder and include the reason; and

(b) Notify the operational supervisor-in-charge of the aircraft call sign.

PHRASEOLOGY–
STOP ALTITUDE SQUAWK. ALTITUDE DIFFERS BY (number of feet) FEET.

e. Whenever possible, inhibit altitude readouts on all consoles when a malfunction of the ground equipment causes repeated invalid readouts.

5-2-18. ALTITUDE CONFIRMATION– MODE C

Request a pilot to confirm assigned altitude on initial contact unless:

NOTE–

For the purpose of this paragraph, “initial contact” means a pilot’s first radio contact with each sector/position.

a. The pilot states the assigned altitude, or

b. You assign a new altitude to a climbing or a descending aircraft, or

c. The Mode C readout is valid and indicates that the aircraft is established at the assigned altitude, or

d. **TERMINAL.** The aircraft was transferred to you from another sector/position within your facility (intrafacility).

PHRASEOLOGY–
(In level flight situations), VERIFY AT (altitude/flight level).

(In climbing/descending situations),

(if aircraft has been assigned an altitude below the lowest useable flight level),

VERIFY ASSIGNED ALTITUDE (altitude).

or

(If aircraft has been assigned a flight level at or above the lowest useable flight level),

VERIFY ASSIGNED FLIGHT LEVEL (flight level).

REFERENCE–
FAAO 7110.65, Beacon Identification Methods, Para 5-3-3

5-2-19. ALTITUDE CONFIRMATION– NON-MODE C

a. Request a pilot to confirm assigned altitude on initial contact unless:

NOTE–

For the purpose of this paragraph, “initial contact” means a pilot’s first radio contact with each sector/position.

1. The pilot states the assigned altitude, or

2. You assign a new altitude to a climbing or a descending aircraft, or

3. **TERMINAL.** The aircraft was transferred to you from another sector/position within your facility (intrafacility).

PHRASEOLOGY–

(In level flight situations), VERIFY AT (altitude/flight level).

(In climbing/descending situations), VERIFY ASSIGNED ALTITUDE/FLIGHT LEVEL (altitude/flight level).

b. **USA.** Reconfirm all pilot altitude read backs.

PHRASEOLOGY–

(If the altitude read back is correct),

AFFIRMATIVE (altitude).

(If the altitude read back is not correct),

NEGATIVE. CLIMB/DESCEND AND MAINTAIN (altitude),

or

NEGATIVE. MAINTAIN (altitude).

REFERENCE–

FAAO 7110.65, Beacon Identification Methods, Para 5-3-3

5-2-20. AUTOMATIC ALTITUDE REPORTING

Inform an aircraft when you want it to turn on/off the automatic altitude reporting feature of its transponder.

PHRASEOLOGY–
SQUAWK ALTITUDE,

or

STOP ALTITUDE SQUAWK.

NOTE–

Controllers should be aware that not all aircraft have a capability to disengage the altitude squawk independently from the beacon code squawk. On some aircraft both functions are controlled by the same switch.

REFERENCE-

FAAO 7110.65, *Validation of Mode C Readout, Para 5-2-17*
 FAAO 7110.65, *Beacon Identification Methods, Para 5-3-3*
P/CG Term- Automatic Altitude Report.

5-2-21. INFLIGHT DEVIATIONS FROM TRANSPONDER/MODE C REQUIREMENTS BETWEEN 10,000 FEET AND 18,000 FEET

Apply the following procedures to requests to deviate from the Mode C transponder requirement by aircraft operating in the airspace of the 48 contiguous states and the District of Columbia at and above 10,000 feet MSL and below 18,000 feet MSL, excluding the airspace at and below 2,500 feet AGL.

NOTE-

1. 14 CFR Section 91.215(b) provides, in part, that all U.S. registered civil aircraft must be equipped with an operable, coded radar beacon transponder when operating in the altitude stratum listed above. Such transponders shall have a Mode 3/A 4096 code capability, replying to Mode 3/A interrogation with the code specified by ATC, or a Mode S capability, replying to Mode 3/A interrogations with the code specified by ATC. The aircraft must also be equipped with automatic pressure altitude reporting equipment having a Mode C capability that automatically replies to Mode C interrogations by transmitting pressure altitude information in 100-foot increments.

2. The exception to 14 CFR Section 91.215 (b) is 14 CFR Section 91.215(b)(5) which states: except balloons, gliders, and aircraft without engine-driven electrical systems.

REFERENCE-

FAAO 7210.3, *Chapter 19, Temporary Flight Restrictions.*

a. Except in an emergency, do not approve inflight requests for authorization to deviate from 14 CFR Section 91.215(b)(5)(i) requirements originated by aircraft without transponder equipment installed.

b. Approve or disapprove other inflight deviation requests, or withdraw approval previously issued to such flights, solely on the basis of traffic conditions and other operational factors.

c. Adhere to the following sequence of action when an inflight VFR deviation request is received from an aircraft with an inoperative transponder or Mode C, or is not Mode C equipped:

1. Suggest that the aircraft conduct its flight in airspace unaffected by the CFRs.

2. Suggest that the aircraft file an IFR flight plan.

3. Suggest that the aircraft provide a VFR route of flight and maintain radio contact with ATC.

d. Do not approve an inflight deviation unless the aircraft has filed an IFR flight plan or a VFR route of flight is provided and radio contact with ATC is maintained.

e. You may approve an inflight deviation request which includes airspace outside your jurisdiction without the prior approval of the adjacent ATC sector/facility providing a transponder/Mode C status report is forwarded prior to control transfer.

f. Approve or disapprove inflight deviation requests within a reasonable period of time or advise when approval/disapproval can be expected.

REFERENCE-

FAAO 7110.65, *Beacon Identification Methods, Para 5-3-3*

5-2-22. BEACON TERMINATION

Inform an aircraft when you want it to turn off its transponder.

PHRASEOLOGY-

STOP SQUAWK.

(For a military aircraft when you do not know if the military service requires that it continue operating on another mode),

STOP SQUAWK (mode in use).

REFERENCE-

FAAO 7110.65, *Beacon Identification Methods, Para 5-3-3*

5-2-23. ALTITUDE FILTERS

TERMINAL

Set altitude filters to display Mode C altitude readouts to encompass all altitudes within the controller's jurisdiction. Set the upper limits no lower than 1,000 feet above the highest altitude for which the controller is responsible. In those stratified positions, set the lower limit to 1,000 feet or more below the lowest altitude for which the controller is responsible. When the position's area of responsibility includes down to an airport field elevation, the facility will normally set the lower altitude filter limit to encompass the field elevation so that provisions of para 2-1-6, Safety Alert, and para 5-2-17, Validation of Mode C Readout, subpara a2 may be applied. Air traffic managers may authorize temporary suspension of this requirement when target clutter is excessive.

Section 3. Radar Identification

5-3-1. APPLICATION

Before you provide radar service, establish and maintain radar identification of the aircraft involved, except as provided in para 5-5-1, Application, subparas b2 and 3.

REFERENCE-

FAAO 7110.65, *Use of Tower Radar Displays, Para 3-1-9*

5-3-2. PRIMARY RADAR IDENTIFICATION METHODS

Identify a primary or radar beacon target by using one of the following methods:

a. Observing a departing aircraft target within 1 mile of the takeoff runway end at airports with an operating control tower, provided one of the following methods of coordination is accomplished.

1. A verbal rolling/boundary notification is issued for each departure, or

2. A nonverbal rolling/boundary notification is used for each departure aircraft.

NOTE-

Nonverbal notification can be accomplished via the use of a manual or electronic "drop tube" or automation.

b. Observing a target whose position with respect to a fix (displayed on the video map, scribed on the map overlay, or displayed as a permanent echo) or a visual reporting point (whose range and azimuth from the radar antenna has been accurately determined and made available to the controller) corresponds with a direct position report received from an aircraft, and the observed track is consistent with the reported heading or route of flight. If a TACAN/VORTAC is located within 6,000 feet of the radar antenna, the TACAN/VORTAC may be used as a reference fix for radar identification without being displayed on the video map or map overlay.

NOTE-

1. *Establishment of radar identification through use of DME position information can be complicated by the fact that some military TACANs are not collocated with frequency-paired VORs and might be separated from them by as much as 31 miles.*

2. *Visual reporting points used for RADAR identification are limited to those most used by pilots and whose range*

and azimuth have been determined by supervisory personnel.

c. Observing a target make an identifying turn or turns of 30 degrees or more, provided the following conditions are met:

NOTE-

Use of identifying turns or headings which would cause the aircraft to follow normal IFR routes or known VFR flight paths might result in misidentification. When these circumstances cannot be avoided, additional methods of identification may be necessary.

1. Except in the case of a lost aircraft, a pilot position report is received which assures you that the aircraft is within radar coverage and within the area being displayed.

2. Only one aircraft is observed making these turns.

3. For aircraft operating in accordance with an IFR clearance, you either issue a heading away from an area which will require an increased minimum IFR altitude or have the aircraft climb to the highest minimum altitude in your area of jurisdiction before you issue a heading.

REFERENCE-

FAAO 7110.65, *Use of Tower Radar Displays, Para 3-1-9*
FAAO 7110.65, *Surveillance Unusable, Para 5-12-1.*

5-3-3. BEACON IDENTIFICATION METHODS

When using only Mode 3/A radar beacon to identify a target, use one of the following methods:

a. Request the aircraft to activate the "IDENT" feature of the transponder and then observe the identification display.

NOTE-

1. *At facilities where the single-slash "IDENT" modification is installed or other decoder modifications have been made which increase the number of "blooming" target displays, it will be necessary to exercise additional care to preclude the possibility of misidentification.*

2. **TERMINAL.** *When automated displays are operated in the analog mode, the "IDENT" return is displayed as a double slash and the emergency return as a single bloomer whenever the beacon control head is in the "fail" position.*

PHRASEOLOGY-

IDENT.

SQUAWK (code) AND IDENT.

b. Request the aircraft to change to a specific discrete or nondiscrete code, as appropriate, and then observe the target or code display change. If a code change is required in accordance with Section 2, Beacon Systems, of this chapter, use the codes specified therein.

c. Request the aircraft to change transponder to “standby.” After you observe the target disappear for sufficient scans to assure that loss of target resulted from placing the transponder in “standby” position, request the aircraft to return transponder to normal operation and then observe the reappearance of the target.

PHRASEOLOGY–
SQUAWK STANDBY,

then

SQUAWK NORMAL.

d. EN ROUTE. During narrowband operations, an aircraft may be considered identified when the full data block is automatically associated with the beacon target symbol of an aircraft that is squawking a discrete code assigned by the computer.

PHRASEOLOGY–
SQUAWK (4 digit discrete code), AND IF YOUR ALTITUDE REPORTING EQUIPMENT IS TURNED OFF, SQUAWK ALTITUDE.

NOTE–

The AIM informs pilots to adjust Mode C transponders with altitude reporting capability activated unless deactivation is requested by ATC. Squawk altitude is included to provide applicable phraseology.

REFERENCE–

FAAO 7110.65, Use of Tower Radar Displays, Para 3–1–9
FAAO 7110.65, Position Information, Para 5–3–6

5–3–4. TERMINAL AUTOMATION SYSTEMS IDENTIFICATION METHODS

TERMINAL

a. Consider an auto-acquired aircraft as identified when the data block is displayed and is visible to you, and one of the following conditions exist:

1. The radar or beacon identification procedures have been used to confirm the identity of the tagged target.

2. The aircraft is being handed off using a NAS automated system and one of the following does not

appear in the data block: “CST”, “NAT”, “NT”, “AMB”, “OLD”, “NB”, “TU”, “AM”, or “OL”.

b. Use the data block to maintain target identity unless it is in a coast status or displaced from the appropriate target.

c. A displaced data block shall be updated at all times.

REFERENCE–

FAAO 7110.65, Use of Tower Radar Displays, Para 3–1–9

5–3–5. QUESTIONABLE IDENTIFICATION

a. Use more than one method of identification when proximity of targets, duplication of observed action, or any other circumstances cause doubt as to target identification.

b. If identification is questionable for any reason, take immediate action to reidentify the aircraft or terminate radar service. Identify the aircraft as follows:

1. As described in para 5–3–2, Primary Radar Identification Methods, or para 5–3–3, Beacon Identification Methods.

2. En route. Ensure that all primary targets are displayed when radar identification is lost or is questionable.

REFERENCE–

FAAO 7110.65, Methods, Para 5–4–3

5–3–6. POSITION INFORMATION

Inform an aircraft of its position whenever radar identification is established by means of identifying turns or by any of the beacon identification methods outlined in para 5–3–3, Beacon Identification Methods. Position information need not be given when identification is established by position correlation or when a departing aircraft is identified within 1 mile of the takeoff runway end.

5–3–7. IDENTIFICATION STATUS

a. Inform an aircraft of radar contact when:

1. Initial radar identification in the ATC system is established.

2. Subsequent to loss of radar contact or terminating radar service, radar identification is reestablished.

PHRASEOLOGY–

RADAR CONTACT (position if required).

- b. Inform an aircraft when radar contact is lost.

PHRASEOLOGY–

RADAR CONTACT LOST (alternative instructions when required).

5-3-8. TARGET MARKERS

EN ROUTE

Retain data blocks that are associated with the appropriate target symbol in order to maintain continuous identity of aircraft. Retain the data block until the aircraft has exited the sector or delegated airspace, and all potential conflicts have been resolved; including an aircraft that is a point out. The data block shall display flight identification and altitude information, as a minimum. The displayed altitude may be assigned, interim, or reported.

5-3-9. TARGET MARKERS

TERMINAL

a. Retain data blocks that are associated with the appropriate target symbol in order to maintain continuous identity of aircraft. Retain the data block

until the aircraft has exited the sector or delegated airspace, and all potential conflicts have been resolved; including an aircraft that is a point out. The data block shall display flight identification and altitude information, as a minimum.

NOTE–

Where delegated airspace extends beyond Class B and/or Class C airspace, the following will apply: If a VFR aircraft is clear of Class B and Class C airspace and radar services have been terminated then retention of the data block is no longer required.

b. During prearranged coordination procedures, the controllers who penetrate another controller's airspace shall display data block information of that controller's aircraft which shall contain, at a minimum, the position symbol and altitude information.

REFERENCE–

FAAO 7110.65, Coordinate Use of Airspace, Para 2-1-14

FAAO 7110.65, Transfer of Radar Identification, Methods, Para 5-4-3

FAAO 7110.65, Automated Information Transfer (AIT), Para 5-4-8

FAAO 7110.65, Prearranged Coordination, Para 5-4-10

FAAO 7210.3, Prearranged Coordination, Para 3-7-7.

Section 4. Transfer of Radar Identification

5-4-1. APPLICATION

To provide continuous radar service to an aircraft and facilitate a safe, orderly, and expeditious flow of traffic, it is often necessary to transfer radar identification of an aircraft from one controller to another. This section describes the terms, methods, and responsibilities associated with this task. Interfacility and intrafacility transfers of radar identification shall be accomplished in all areas of radar surveillance except where it is not operationally feasible. Where such constraints exist, they shall be:

- a. Covered in letters of agreement which clearly state that control will not be based upon a radar handoff, or
- b. Coordinated by the transferring and receiving controllers for a specified period of time.

REFERENCE-

FAAO 7110.65, *Coordination with Receiving Facility, Para 4-3-8*

5-4-2. TERMS

a. *Handoff.* An action taken to transfer the radar identification of an aircraft from one controller to another controller if the aircraft will enter the receiving controller's airspace and radio communications with the aircraft will be transferred.

b. *Radar Contact.* The term used to inform the controller initiating a handoff that the aircraft is identified and approval is granted for the aircraft to enter the receiving controller's airspace.

c. *Point Out.* A physical or automated action taken by a controller to transfer the radar identification of an aircraft to another controller if the aircraft will or may enter the airspace or protected airspace of another controller and radio communications will not be transferred.

d. *Point Out Approved.* The term used to inform the controller initiating a point out that the aircraft is identified and that approval is granted for the aircraft to enter the receiving controller's airspace, as coordinated, without a communications transfer or the appropriate automated system response.

e. *Traffic.* A term used to transfer radar identification of an aircraft to another controller for the purpose

of coordinating separation action. Traffic is normally issued:

1. In response to a handoff or point out;
2. In anticipation of a handoff or point out; or
3. In conjunction with a request for control of an aircraft.

f. *Traffic Observed.* The term used to inform the controller issuing the traffic restrictions that the traffic is identified and that the restrictions issued are understood and will be complied with.

5-4-3. METHODS

a. Transfer the radar identification of an aircraft by at least one of the following methods:

1. Physically point to the target on the receiving controller's display.
2. Use landline voice communications.
3. Use automation capabilities.

NOTE-

EN ROUTE. Interfacility handoff capabilities are available that can be manually initiated and accepted when operating on the backup RDP while FDP is available. The backup RDP by itself does not have the capabilities for interfacility handoffs. Therefore, handoffs between facilities must be made via landline voice communications when operating with the backup RDP only.

4. *TERMINAL.* Use the "Modify" or "Quick Look" functions for data transfer between the TRACON and tower cab only if specific procedures are established in a facility directive. The local controller has the responsibility to determine whether or not conditions are adequate for the use of ARTS/STARS data on the BRITE/DBRITE/TDW.

REFERENCE-

FAAO 7210.3, *Use of Modify and Quick Look Functions, Para 11-2-4.*
FAAO 7210.3, *Use of Stars Quick Look Functions, Para 11-8-4.*

b. When making a handoff, point-out, or issuing traffic restrictions, relay information to the receiving controller in the following order:

1. The position of the target relative to a fix, map symbol, or radar target known and displayed by both the receiving and transferring controller. Mileage from the reference point may be omitted when

relaying the position of a target if a full data block associated with the target has been forced on the receiving controller's radar display.

EXAMPLE-

"Point out, Southwest of Richmond VOR . . ."

2. The aircraft identification, as follows:

(a) The aircraft call sign, or

(b) The discrete beacon code of the aircraft during interfacility point-outs only, if both the receiving and the transferring controllers agree.

NOTE-

Acceptance of a point-out using the discrete beacon code as the aircraft's identification constitutes agreement.

3. The assigned altitude, appropriate restrictions, and information that the aircraft is climbing or descending, if applicable, except when inter/intrafacility directives ensure that the altitude information will be known by the receiving controller.

NOTE-

1. *When physically pointing to the target, you do not have to state the aircraft position.*

2. *Those en route facilities using host software that provides capability for passing interim altitude shall include the specific operations and procedures for use of this procedure in a LOA between the appropriate facilities.*

PHRASEOLOGY-

HANDOFF/POINT-OUT/TRAFFIC (aircraft position) (aircraft ID),

or

(discrete beacon code point-out only) (altitude, restrictions, and other appropriate information, if applicable).

c. When receiving a handoff, point-out, or traffic restrictions, respond to the transferring controller as follows:

PHRASEOLOGY-

(Aircraft ID) (restrictions, if applicable) **RADAR CONTACT,**

or

(aircraft ID or discrete beacon code) (restrictions, if applicable) POINT-OUT APPROVED,

or

TRAFFIC OBSERVED,

or

UNABLE (appropriate information, as required).

d. If any doubt as to target identification exists after attempting confirmation in accordance with this section, apply the provisions of para 5-3-5, Questionable Identification.

REFERENCE-

FAAO 7110.65, *Validation of Mode C Readout, Para 5-2-17*

5-4-4. TRAFFIC

a. When using the term "traffic" for coordinating separation, the controller issuing traffic shall issue appropriate restrictions.

b. The controller accepting the restrictions shall be responsible to ensure that approved separation is maintained between the involved aircraft.

5-4-5. TRANSFERRING CONTROLLER HANDOFF

The transferring controller shall:

a. Complete a radar handoff prior to an aircraft's entering the airspace delegated to the receiving controller.

REFERENCE-

FAAO 7110.65, *Coordinate Use of Airspace, Para 2-1-14*

FAAO 7110.65, *Control Transfer, Para 2-1-15*

FAAO 7110.65, *Receiving Controller Handoff, Para 5-4-6*

b. Verbally obtain the receiving controller's approval prior to making any changes to an aircraft's flight path, altitude, or data block information while the handoff is being initiated or after acceptance, unless otherwise specified by a LOA or a facility directive.

NOTE-

Those en route facilities using host software that provides capability for passing interim altitude shall include the specific operations and procedures for use of this procedure in a LOA between the appropriate facilities.

c. Ensure that, prior to transferring communications:

1. Potential violations of adjacent airspace and potential conflicts between aircraft in their own area of jurisdiction are resolved.

2. Necessary coordination has been accomplished with all controllers through whose area of jurisdiction the aircraft will pass prior to entering the receiving controller's area of jurisdiction, except

when such coordination is the receiving controller's responsibility as stated in para 5-4-6, Receiving Controller Handoff, and unless otherwise specified by a LOA or a facility directive.

3. Restrictions issued to ensure separation are passed to the receiving controller.

d. After transferring communications, continue to comply with the requirements of subparas c1 and 2.

e. Comply with restrictions issued by the receiving controller unless otherwise coordinated.

f. Comply with the provisions of para 2-1-17, Radio Communications Transfer, subparas a and b. To the extent possible, transfer communications when the transfer of radar identification has been accepted.

NOTE-

Before the ARTS/STARS "modify/quick look" function is used to transfer radar identification, a facility directive which specifies communication transfer points is required.

g. Advise the receiving controller of pertinent information not contained in the data block or flight progress strip unless covered in a LOA or facility directive. Pertinent information includes:

1. Assigned heading.

2. Air speed restrictions.

3. Altitude information issued.

4. Observed track or deviation from the last route clearance.

5. The beacon code if different from that normally used or previously coordinated.

6. Any other pertinent information.

h. Ensure that the data block is associated with the appropriate target.

i. Initiate verbal coordination to verify the position of primary or nondiscrete targets when using the automated handoff functions except for intrafacility handoffs using single-sensor systems or multisensor systems operating in a mosaic RDP mode.

j. Initiate verbal coordination before transferring control of a track when "CST", "FAIL", "NONE", "NB", "NX", "IF", or "NT" is displayed in the data block.

k. Advise the receiving controller that radar monitoring is required when the aircraft is on a direct

route initiated by ATC that exceeds usable NAVAID distances.

l. Issue restrictions to the receiving controller which are necessary to maintain separation from other aircraft within your area of jurisdiction before releasing control of the aircraft.

m. Consider the target being transferred as identified on the receiving controller's display when the receiving controller acknowledges receipt verbally or has accepted an automated handoff.

n. Accomplish the necessary coordination with any intervening controllers whose area of jurisdiction is affected by the receiving controller's delay in the climb or the descent of an aircraft through the vertical limits of your area of jurisdiction when the receiving controller advises you of that delay before accepting the transfer of radar identification unless otherwise specified by a LOA or a facility directive.

5-4-6. RECEIVING CONTROLLER HANDOFF

The receiving controller shall:

a. Ensure that the target position corresponds with the position given by the transferring controller or that there is an appropriate association between an automated data block and the target being transferred before accepting a handoff.

REFERENCE-

FAAO 7110.65, Coordinate Use of Airspace, Para 2-1-14

FAAO 7110.65, Control Transfer, Para 2-1-15

FAAO 7110.65, Transferring Controller Handoff, Para 5-4-5

b. Issue restrictions that are needed for the aircraft to enter your sector safely before accepting the handoff.

c. Comply with restrictions issued by the initiating controller unless otherwise coordinated.

d. Before you issue control instructions directly to an aircraft that is within another controller's area of jurisdiction that will change that aircraft's heading, route, speed, altitude, or beacon code, ensure that coordination has been accomplished with each of the controllers listed below whose area of jurisdiction is affected by those instructions unless otherwise specified by a LOA or a facility directive:

NOTE-

Those en route facilities using host software that provides capability for passing interim altitude shall include the specific operations and procedures for use of this procedure in a LOA between the appropriate facilities.

1. The controller within whose area of jurisdiction the control instructions will be issued.

2. Any intervening controller(s) through whose area of jurisdiction the aircraft will pass.

e. After accepting a handoff from another controller, confirm the identity of primary target by advising the aircraft of its position, and of a beacon target by observing a code change, an “ident” reply, or a “standby” squawk unless one of these was used during handoff. These provisions do not apply at those towers and GCAs which have been delegated the responsibility for providing radar separation within designated areas by the parent approach control facility and the aircraft identification is assured by sequencing or positioning prior to the handoff.

REFERENCE-

FAAO 7110.65, Approach Separation Responsibility, Para 5-9-5

f. When using appropriate equipment, consider a discrete beacon target’s identity to be confirmed when:

1. The data block associated with the target being handed off indicates the computer assigned discrete beacon code is being received, or

2. You observe the deletion of a discrete code that was displayed in the data block, or

NOTE-

When the aircraft generated discrete beacon code does not match the computer assigned beacon code, the code generated will be displayed in the data block. When the aircraft changes to the assigned discrete code, the code disappears from the data block. In this instance, the observance of code removal from the data block satisfies confirmation requirements.

3. You observe the numeric display of a discrete code that an aircraft has been instructed to squawk or reports squawking.

g. Initiate verbal coordination prior to accepting control of a track when “CST”, “NAT”, “NT”, “NONE”, “NB”, “NX”, “OLD”, “OL”, “AMB”, “AM”, or “TU” is displayed in the data block.

1. When an automated interfacility handoff action is initiated and “AMB” or “AM” is displayed in the full data block, advise the other facility that a disparity exists between the position declared by their

computer and that declared by your ARTS/PIDP/STARS system.

2. When an automated interfacility handoff action is initiated and “NAT,” “NT,” or “TU” is displayed in the full data block, advise the other facility if a disparity exists between the position declared by their computer and the actual target position.

h. Advise the transferring controller, prior to accepting the transfer of radar identification, that you will delay the climb or the descent of an aircraft through the vertical limits of the transferring controller’s area of jurisdiction, unless otherwise specified in a LOA or a facility directive.

NOTE-

Those en route facilities using HOST software that provides capability for passing interim altitude shall include the specific operations and procedures for use of this procedure in a LOA between the appropriate facilities.

i. If you decide, *after* accepting the transfer of radar identification, to delay the aircraft’s climb or descent through the vertical limits of the transferring controller’s area of jurisdiction, advise the transferring controller of that decision as soon as possible. *You* now have the responsibility to ensure that the necessary coordination is accomplished with any intervening controller(s) whose area of jurisdiction is affected by that delay, unless otherwise specified in a LOA or a facility directive.

NOTE-

Those en route facilities using HOST software that provides capability for passing interim altitude shall include the specific operations and procedures for use of this procedure in a LOA between the appropriate facilities.

5-4-7. POINT OUT

a. The transferring controller shall:

1. Obtain verbal approval before permitting an aircraft to enter the receiving controller’s delegated airspace. **TERMINAL.** Automated approval may be utilized in lieu of verbal, provided the appropriate automation software is operational (automated point out function), and the procedures are specified in a facility directive/LOA.

2. Obtain the receiving controller’s approval before making any changes to an aircraft’s flight path, altitude, or data block information after the point out has been approved.

NOTE-

Those en route facilities using HOST software that provides capability for passing interim altitude shall include the specific operations and procedures for use of this procedure in a LOA between the appropriate facilities.

3. Comply with restrictions issued by the receiving controller unless otherwise coordinated.

4. Be responsible for subsequent radar handoffs and communications transfer, including flight data revisions and coordination, unless otherwise agreed to by the receiving controller or as specified in a LOA.

b. The receiving controller shall:

1. Ensure that the target position corresponds with the position given by the transferring controller or that there is an association between a computer data block and the target being transferred prior to approving a point out.

2. Be responsible for separation between point out aircraft and other aircraft for which he/she has separation responsibility.

3. Issue restrictions necessary to provide separation from other aircraft within his/her area of jurisdiction.

5-4-8. AUTOMATED INFORMATION TRANSFER (AIT)

Transfer radar identification, altitude control, and/or en route fourth line control information, without verbal coordination under the following conditions:

- a. During radar handoff; and
- b. Via information displayed in full data blocks; and
- c. Within the same facility, except as provided in para 5-4-9, Interfacility Automated Information Transfer; and
- d. When following procedures specified in your facility AIT directive.

REFERENCE-

FAAO 7110.65, *En Route Fourth Line Data Block Usage, Para 5-4-1.*

5-4-9. INTERFACILITY AUTOMATED INFORMATION TRANSFER**EN ROUTE**

Transfer radar identification without verbal coordination under the following conditions:

- a. During radar handoff; and
- b. Via information displayed in full data blocks; and
- c. On aircraft at assigned altitude in level flight; and
- d. Only the first sector within the receiving facility shall utilize the procedure; and
- e. When following procedures specified in your facility AIT directive and LOA.

5-4-10. PREARRANGED COORDINATION

Prearranged coordination allowing aircraft under your control to enter another controller's area of jurisdiction may only be approved provided procedures are established and published in a facility directive/LOA in accordance with FAAO 7210.3, para 3-7-7, Prearranged Coordination.

NOTE-

Under no circumstances may one controller permit an aircraft to enter another's airspace without proper coordination. Coordination can be accomplished by several means; i.e., radar handoff, automated information transfer, verbal, point-out, and by prearranged coordination procedures identified in a facility directive that clearly describe the correct application. Airspace boundaries should not be permitted to become barriers to the efficient movement of traffic. In addition, complete coordination, awareness of traffic flow, and understanding of each position's responsibility concerning penetration of another's airspace cannot be overemphasized.

REFERENCE-

FAAO 7110.65, *Coordinate Use of Airspace, Para 2-1-14*

FAAO 7110.65, *Transfer of Radar Identification, Methods, Para 5-4-3*

FAAO 7110.65, *Automated Information Transfer (AIT), Para 5-4-8*

FAAO 7210.3, *Prearranged Coordination, Para 3-7-7.*

5-4-11. EN ROUTE FOURTH LINE DATA BLOCK USAGE

a. The en route fourth line data block shall be used to forward only the specified control information listed below. Any additional control information shall be forwarded via other communication methods. En route fourth line data block free text area may be used by individual sector teams for recording any additional information the team deems appropriate for managing the sector, but shall be removed prior to initiation of identification transfer.

REFERENCE-

FAAO 7110.65, *Transferring Controller Handoff, Para 5-4-5b.*

b. The en route fourth line data block area shall be used for coordination purposes only in association with radar identified aircraft.

c. When automated information transfer (AIT) procedures are applied, en route fourth line usage for transfer of control information shall be specifically defined within facility AIT directive.

REFERENCE-

FAAO 7110.65, *Automated Information Transfer (AIT), Para 5-4-8.*
FAAO 7210.3, *Automated Information Transfer (AIT), Para 4-3-8.*

d. Coordination format for assigned headings shall use the designation character “H” preceding a three-digit number.

EXAMPLE-

H080, H270

e. Aircraft assigned a heading until receiving a fix or joining a published route shall be designated with assigned heading format followed by the fix or route.

EXAMPLE-

H080/ALB, 080/J121, PH/ALB

NOTE-

1. The notation “PH” may be used to denote present heading.

2. The character “H” may be omitted as a prefix to the heading assignment only if necessary due to character field limitations, and it does not impede understanding.

f. Aircraft authorized specific weather deviation or lateral weather deviation until able to proceed direct to a fix shall be designated with the identified characters: D-deviation, L-left, R-right, N-north, E-east, S-south, W-west.

EXAMPLE-

DN, D20L, DR/ATL, D30R/ATL

g. Coordination format for assigned airspeeds shall use the designation character “S” preceding a three-digit number.

NOTE-

A “+” notation may be added to denote an assigned speed at or greater than the displayed value. A “-” notation may be added to denote an assigned speed at or less than the displayed value.

EXAMPLE-

S210, S250, S250+, S280-

h. Aircraft assigned a Mach number shall use the designation “M” preceding the two-digit assigned value.

EXAMPLE-

M80, M80+, M80-

REFERENCE-

FAAO 7110.65, *En Route Fourth Line Data Block Usage, Para 5-4-1gNOTE.*

i. Aircraft authorized to conduct celestial navigation training within 30 NM of the route centerline specified within the en route clearance.

EXAMPLE-

CELNAV

j. Coordination format for aircraft requesting an altitude change shall use the designation characters “RQ” preceding a three-digit number.

EXAMPLE-

RQ170, RQ410

k. Coordination format for aircraft requesting a route change shall use the designation “RQ/” preceding a specific fix identifier.

EXAMPLE-

RQ/LAX, RQ/NEUTO

l. The acceptance of a handoff by the receiving controller shall constitute approval of the information contained within the en route fourth line data block. It is the responsibility of the receiving controller to advise the transferring controller if any information is not understood, or needs to be revised.

NOTE-

Due to system and character limitations the usage of these standardized entries may require additional support via facility directive in order to provide complete coordination.

m. All other control information shall be coordinated via other methods.

Section 5. Radar Separation

5-5-1. APPLICATION

a. Radar separation shall be applied to all RNAV aircraft operating on a random (impromptu) route at or below FL 450 and to all published Q routes in the conterminous United States.

b. Radar separation may be applied between:

1. Radar identified aircraft.

2. An aircraft taking off and another radar identified aircraft when the aircraft taking off will be radar-identified within 1 mile of the runway end.

3. A radar-identified aircraft and one not radar-identified when either is cleared to climb/descend through the altitude of the other provided:

(a) The performance of the radar system is adequate and, as a minimum, primary radar targets or ASR-9/Full Digital Radar Primary Symbol targets are being displayed on the display being used within the airspace within which radar separation is being applied; and

(b) Flight data on the aircraft not radar-identified indicate it is a type which can be expected to give adequate primary/ASR-9/Full Digital Radar Primary Symbol return in the area where separation is applied; and

(c) The airspace within which radar separation is applied is not less than the following number of miles from the edge of the radar display:

(1) When less than 40 miles from the antenna— *6 miles*;

(2) When 40 miles or more from the antenna— *10 miles*;

(3) Narrowband radar operations— *10 miles*; and

(d) Radar separation is maintained between the radar-identified aircraft and all observed primary, ASR-9/Full Digital Radar Primary Symbol, and secondary radar targets until nonradar separation is established from the aircraft not radar identified; and

(e) When the aircraft involved are on the same relative heading, the radar-identified aircraft is vectored a sufficient distance from the route of the aircraft not radar identified to assure the targets are

not superimposed prior to issuing the clearance to climb/descend.

REFERENCE—

FAAO 7110.65, Exceptions, Para 4-1-2

FAAO 7110.65, Route Use, Para 4-4-1

FAAO 7110.65, Application, Para 5-3-1

FAAO 7110.65, Additional Separation for Formation Flights, Para 5-5-8

FAAO 7110.65, Approach Separation Responsibility, Para 5-9-5

5-5-2. TARGET SEPARATION

a. Apply radar separation:

1. Between the centers of primary radar targets; however, do not allow a primary target to touch another primary target or a beacon control slash.

2. Between the ends of beacon control slashes.

NOTE—

At TPX-42 sites, the bracket video feature must be activated to display the beacon control slash.

3. Between the end of a beacon control slash and the center of a primary target.

4. All-digital displays. Between the centers of digitized targets. Do not allow digitized targets to touch.

REFERENCE—

FAAO 7110.65, Simultaneous Independent ILS/MLS Approaches—Dual & Triple, Para 5-9-7

5-5-3. TARGET RESOLUTION

a. A process to ensure that correlated radar targets or digitized targets do not touch.

b. Mandatory traffic advisories and safety alerts shall be issued when this procedure is used.

NOTE—

This procedure shall not be provided utilizing mosaic radar systems.

c. Target resolution shall be applied as follows:

1. Between the edges of two primary targets or the edges of primary digitized targets.

2. Between the end of the beacon control slash and the edge of a primary target or primary digitized target.

3. Between the ends of two beacon control slashes.

5-5-4. MINIMA

Separate aircraft by the following minima:

NOTE-

Wake turbulence procedures specify increased separation minima required for certain classes of aircraft because of the possible effects of wake turbulence.

a. Broadband Radar System or Full Digital Terminal Radar System:

NOTE-

Includes single sensor long range radar mode.

1. When less than 40 miles from the antenna– 3 miles.
2. When 40 miles or more from the antenna– 5 miles.

b. Stage A/DARC, MEARTS Mosaic Mode, Terminal Mosaic/Multi-Sensor Mode:

NOTE-

Mosaic/Multi-Sensor Mode combines radar input from 2 to 16 sites into a single picture utilizing a mosaic grid composed of radar sort boxes.

1. Below FL 600– 5 miles.
2. At or above FL 600– 10 miles.
3. For areas meeting all of the following conditions:
 - (a) Radar site adaptation is set to single sensor.
 - (b) Significant operational advantages can be obtained.
 - (c) Within 40 miles of the antenna.
 - (d) Below FL 180.
 - (e) Facility directives specifically define the area where the separation can be applied. Facility directives may specify 3 miles.

REFERENCE-

*FAAO 7210.3, Single Site Coverage Stage A Operations, Para 8-2-1.
FAAO 7210.3, Single Site Coverage ATTS Operations, Para 11-8-15.*

4. When transitioning from terminal to en route control, 3 miles increasing to 5 miles or greater, provided:

- (a) The aircraft are on diverging routes/courses, and/or
- (b) The leading aircraft is and will remain faster than the following aircraft; and

(c) Separation constantly increasing and the first center controller will establish 5 NM or other appropriate form of separation prior to the aircraft departing the first center sector; and

(d) The procedure is covered by a letter of agreement between the facilities involved and limited to specified routes and/or sectors/positions.

c. MEARTS Mosaic Mode:

NOTE-

1. Sensor Mode displays information from the radar input of a single site.

2. Procedures to convert MEARTS Mosaic Mode to MEARTS Sensor Mode at each PVD/MDM will be established by facility directive.

1. When less than 40 miles from the antenna– 3 miles.
2. When 40 miles or more from the antenna– 5 miles.

d. STARS Multi-Sensor Mode:

NOTE-

1. In Multi-Sensor Mode, STARS displays targets as filled and unfilled boxes, depending upon the target's distance from the radar site providing the data. Since there is presently no way to identify which specific site is providing data for any given target, utilize separation standards for targets 40 or more miles from the antenna.

2. When operating in STARS Single Sensor Mode, if TRK appears in the data block, handle in accordance with para 5-3-7 Identification Status, subpara b, and take appropriate steps to establish nonradar separation.

3. TRK appears in the data block whenever the aircraft is being tracked by a radar site other than the radar currently selected. Current equipment limitations preclude a target from being displayed in the single sensor mode; however, a position symbol and data block, including altitude information, will still be displayed. Therefore, low altitude alerts shall be provided in accordance with para 2-1-6 Safety Alert.

WAKE TURBULENCE APPLICATION

e. Separate aircraft operating directly behind, or directly behind and less than 1,000 feet below, or following an aircraft conducting an instrument approach by:

NOTE-

Consider parallel runways less than 2,500 feet apart as a single runway because of the possible effects of wake turbulence.

1. Heavy behind heavy— 4 miles.
2. Large/heavy behind B757— 4 miles.
3. Small behind B757— 5 miles.
4. Small/large behind heavy — 5 miles.

WAKE TURBULENCE APPLICATION

f. TERMINAL. In addition to subpara e, separate an aircraft landing behind another aircraft on the same runway, or one making a touch-and-go, stop-and-go, or low approach by ensuring the following minima will exist at the time the preceding aircraft is over the landing threshold:

NOTE—

Consider parallel runways less than 2,500 feet apart as a single runway because of the possible effects of wake turbulence.

1. Small behind large— 4 miles.
2. Small behind B757— 5 miles.
3. Small behind heavy— 6 miles.

g. TERMINAL. 2.5 nautical miles (NM) separation is authorized between aircraft established on the final approach course within 10 NM of the landing runway when operating in single sensor slant range mode and aircraft remains within 40 miles of the antenna and:

1. The leading aircraft's weight class is the same or less than the trailing aircraft;
2. Heavy aircraft and the Boeing 757 are permitted to participate in the separation reduction as the trailing aircraft only;
3. An average runway occupancy time of 50 seconds or less is documented;
4. CTRDs are operational and used for quick glance references;

REFERENCE—

FAAO 7110.65, Use of Tower Radar Displays, Para 3-1-9

5. Turnoff points are visible from the control tower.

REFERENCE—

FAAO 7110.65, Wake Turbulence, Para 2-1-19
FAAO 7110.65, Same Runway Separation, Para 3-9-6
FAAO 7110.65, Passing or Diverging, Para 5-5-7
FAAO 7110.65, Separation from Obstructions, Para 5-5-9
FAAO 7110.65, Successive or Simultaneous Departures, Para 5-8-3
FAAO 7110.65, Approach Separation Responsibility, Para 5-9-5
FAAO 7110.65, Sequencing, Para 7-6-7
FAAO 7110.65, Separation, Para 7-7-3

FAAO 7110.65 Separation, Para 7-8-3

FAAO 7210.3, Reduced Separation on Final, Para 10-4-7.

5-5-5. VERTICAL APPLICATION

Aircraft not laterally separated, may be vertically separated by one of the following methods:

a. Assign altitudes to aircraft, provided valid Mode C altitude information is monitored and the applicable separation minima is maintained at all times.

REFERENCE—

FAAO 7110.65, Vertical Separation Minima, Para 4-5-1
FAAO 7110.65, Validation of Mode C Readout, Para 5-2-17
FAAO 7110.65, Separation, Para 7-7-3
FAAO 7110.65, Separation, Para 7-8-3
FAAO 7110.65, Separation, Para 7-9-4

b. Assign an altitude to an aircraft after the aircraft previously at that altitude has been issued a climb/descent clearance and is observed (valid Mode C), or reports leaving the altitude.

NOTE—

1. *Consider known aircraft performance characteristics, pilot furnished and/or Mode C detected information which indicate that climb/descent will not be consistent with the rates recommended in the AIM.*

2. *It is possible that the separation minima described in para 4-5-1 Vertical Separation Minima, para 7-7-3 Separation, para 7-8-3 Separation, or para 7-9-4 Separation, might not always be maintained using subpara b. However, correct application of this procedure will ensure that aircraft are safely separated because the first aircraft must have already vacated the altitude prior to the assignment of that altitude to the second aircraft.*

REFERENCE—

FAAO 7110.65, Procedural Preference, Para 2-1-3
FAAO 7110.65, Vertical Separation Minima, Para 4-5-1
FAAO 7110.65, Validation of Mode C Readout, Para 5-2-17
FAAO 7110.65, Application, Para 6-6-1

5-5-6. EXCEPTIONS

a. Do not use Mode C to effect vertical separation with an aircraft on a cruise clearance, contact approach, or as specified in para 5-15-4, System Requirements, subpara e3.

REFERENCE—

FAAO 7110.65, Exceptions, Para 6-6-2
FAAO 7110.65, Contact Approach, Para 7-4-6
P/CG Term— Cruise.

b. Assign an altitude to an aircraft only after the aircraft previously at that altitude is observed at or passing through another altitude separated from the first by the appropriate minima when:

1. Severe turbulence is reported.
2. Aircraft are conducting military aerial refueling.

REFERENCE-

FAAO 7110.65, *Military Aerial Refueling, Para 9-3-12*

3. The aircraft previously at that altitude has been issued a climb/descent at pilot's discretion.

5-5-7. PASSING OR DIVERGING

a. TERMINAL. In accordance with the following criteria, all other approved separation may be discontinued, and passing or diverging separation applied when:

1. Aircraft are on opposite/reciprocal courses and you have observed that they have passed each other; or aircraft are on same or crossing courses and one aircraft has crossed the projected course of the other and the angular difference between their courses is at least 15 degrees.

2. The tracks are monitored to ensure that the primary targets, beacon control slashes, or full digital terminal system primary and/or beacon target symbols will not touch.

REFERENCE-

FAAO 7110.65, *Course Definitions, Para 1-2-2.*

NOTE-

Although all other approved separation may be discontinued, the requirements of para 5-5-4 Minima, subparas e and f shall apply when operating behind a heavy jet/B757.

b. EN ROUTE. Vertical separation between aircraft may be discontinued when they are on opposite courses as defined in para 1-2-2, Course Definitions; and

1. You are in communications with both aircraft involved; and
2. You tell the pilot of one aircraft about the other aircraft, including position, direction, type; and
3. One pilot reports having seen the other aircraft and that the aircraft have passed each other; and
4. You have observed that the radar targets have passed each other; and
5. You have advised the pilots if either aircraft is classified as a heavy jet/B757 aircraft.

6. Although vertical separation may be discontinued, the requirements of para 5-5-4, Minima, subparas e and f must be applied when operating behind a heavy jet/B757.

EXAMPLE-

"Traffic, twelve o'clock, Boeing Seven Twenty Seven, opposite direction. Do you have it in sight?"

(If the answer is in the affirmative):

"Report passing the traffic."

(When pilot reports passing the traffic and the radar targets confirm that the traffic has passed, issue appropriate control instructions.)

5-5-8. ADDITIONAL SEPARATION FOR FORMATION FLIGHTS

Because of the distance allowed between formation aircraft and lead aircraft, additional separation is necessary to ensure the periphery of the formation is adequately separated from other aircraft, adjacent airspace, or obstructions. Provide supplemental separation for formation flights as follows:

- a. Separate a standard formation flight by adding 1 mile to the appropriate radar separation minima.

REFERENCE-

FAAO 7110.65, *Formation Flights, Para 2-1-13*

FAAO 7110.65, *Application, Para 5-5-1*

FAAO 7110.65, *Separation, Para 7-7-3*

P/CG Term- Formation Flight.

- b. Separate two standard formation flights from each other by adding 2 miles to the appropriate separation minima.

- c. Separate a nonstandard formation flight by applying the appropriate separation minima to the perimeter of the airspace encompassing the nonstandard formation or from the outermost aircraft of the nonstandard formation whichever applies.

NOTE-

Aircraft operating in a formation flight are considered non-RVSM aircraft regardless of their single-ship status.

REFERENCE-

FAAO 7110.65, *Vertical Separation Minima, Para 4-5-1.*

- d. If necessary for separation between a nonstandard formation and other aircraft, assign an appropriate beacon code to each aircraft in the formation or to the first and last aircraft in-trail.

NOTE—

The additional separation provided in para 5-5-8 Additional Separation for Formation Flights, is not normally added to wake turbulence separation when a formation is following a heavier aircraft since none of the formation aircraft are likely to be closer to the heavier aircraft than the lead aircraft (to which the prescribed wake turbulence separation has been applied).

REFERENCE—

FAAO 7110.65, Military Aerial Refueling, Para 9-3-12

5-5-9. SEPARATION FROM OBSTRUCTIONS

a. Except in En Route Stage A/DARC or Stage A/EDARC, separate aircraft from obstructions depicted on the radar display by the following minima:

- 1.** When less than 40 miles from the antenna—*3 miles.*
- 2.** When 40 miles or more from the antenna—*5 miles.*

b. Except in En Route Stage A/DARC or Stage A/EDARC, vertical separation of aircraft above an obstruction depicted on the radar display may be discontinued after the aircraft has passed it.

c. En Route Stage A/DARC or Stage A/EDARC, apply the radar separation minima specified in para 5-5-4, Minima, subpara b1.

5-5-10. ADJACENT AIRSPACE

a. If coordination between the controllers concerned has not been effected, separate radar-controlled aircraft from the boundary of adjacent airspace in which radar separation is also being used by the following minima:

REFERENCE—

FAAO 7110.65, Coordinate Use of Airspace, Para 2-1-14

- 1.** When less than 40 miles from the antenna—*1 1/2 miles.*
- 2.** When 40 miles or more from the antenna—*2 1/2 miles.*
- 3.** En route Stage A/DARC or Stage A/EDARC:
 - (a)** Below Flight Level 600—*2 1/2 miles.*
 - (b)** Flight Level 600 and above—*5 miles.*

b. Separate radar-controlled aircraft from the boundary of airspace in which nonradar separation is being used by the following minima:

- 1.** When less than 40 miles from the antenna—*3 miles.*
- 2.** When 40 miles or more from the antenna—*5 miles.*
- 3.** En route Stage A/DARC or Stage A/EDARC:
 - (a)** Below Flight Level 600—*5 miles.*
 - (b)** Flight Level 600 and above—*10 miles.*

c. The provisions of subparas a and b do not apply to VFR aircraft being provided Class B, Class C, or TRSA services. Ensure that the targets of these aircraft do not touch the boundary of adjacent airspace.

d. VFR aircraft approaching Class B, Class C, Class D, or TRSA airspace which is under the control jurisdiction of another air traffic control facility should either be provided with a radar handoff or be advised that radar service is terminated, given their position in relation to the Class B, Class C, Class D, or TRSA airspace, and the ATC frequency, if known, for the airspace to be entered. These actions should be accomplished in sufficient time for the pilot to obtain the required ATC approval prior to entering the airspace involved, or to avoid the airspace.

5-5-11. EDGE OF SCOPE

Separate a radar-controlled aircraft climbing or descending through the altitude of an aircraft that has been tracked to the edge of the scope/display by the following minima until nonradar separation has been established:

- a.** When less than 40 miles from the antenna—*3 miles* from edge of scope.
- b.** When 40 miles or more from the antenna—*5 miles* from edge of scope.
- c.** En route Stage A/DARC or Stage A/EDARC:
 - 1.** Below Flight Level 600—*5 miles.*
 - 2.** Flight Level 600 and above—*10 miles.*

5-5-12. BEACON TARGET DISPLACEMENT

When using a radar target display with a previously specified beacon target displacement to separate a beacon target from a primary target, adjacent airspace, obstructions, or terrain, add a 1 mile correction factor to the applicable minima. The maximum allowable beacon target displacement which may be specified by the facility air traffic manager is $\frac{1}{2}$ mile.

REFERENCE-

FAAO 7210.3, *Monitoring of Mode 3/A Radar Beacon Codes*, Para 3-7-4.

5-5-13. GPA 102/103 CORRECTION FACTOR

When using a radar display whose primary radar video is processed by the GPA 102/103 modification to a joint-use radar system, apply the following correction factors to the applicable minima:

- a. If less than 40 miles from the antenna– add *1 mile*.
- b. If 40 miles or more but not over 200 miles from the antenna– add *3 miles*.

Section 6. Vectoring

5-6-1. APPLICATION

Vector aircraft:

a. In controlled airspace for separation, safety, noise abatement, operational advantage, or when a pilot requests. Allow aircraft operating on an RNAV route to remain on their own navigation to the extent possible.

b. In Class G airspace only upon pilot request and as an additional service.

c. At or above the MVA or the minimum IFR altitude except as authorized for radar approaches, special VFR, VFR operations, or by para 5-6-3, Vectors Below Minimum Altitude.

NOTE-

VFR aircraft not at an altitude assigned by ATC may be vectored at any altitude. It is the responsibility of the pilot to comply with the applicable parts of CFR Title 14.

REFERENCE-

*FAAO 7110.65, Minimum En Route Altitudes, Para 4-5-6
FAAO 7110.65, Priority, Para 7-5-2
FAAO 7110.65, Altitude Assignment, Para 7-5-4
FAAO 7110.65, Altitude Assignments, Para 7-7-5
14 CFR Section 91.119, Minimum Safe Altitudes: General.*

d. In airspace for which you have control jurisdiction, unless otherwise coordinated.

e. So as to permit it to resume its own navigation within radar coverage.

f. Operating special VFR only within Class B, Class C, Class D, or Class E surface areas.

g. Operating VFR at those locations where a special program is established, or when a pilot requests, or you suggest and the pilot concurs.

REFERENCE-

*FAAO 7110.65, Route Use, Para 4-4-1
FAAO 7110.65, Visual Separation, Para 7-2-1
FAAO 7110.65, Separation, Para 7-5-3
FAAO 7110.65, Application, Para 7-6-1
FAAO 7110.65, Separation Minima, Para 9-5-4
FAAO 7210.3, Chapter 11, Section 1, Terminal VFR Radar Services.*

5-6-2. METHODS

a. Vector aircraft by specifying:

1. Direction of turn, if appropriate, and magnetic heading to be flown, or

PHRASEOLOGY-

TURN LEFT/RIGHT HEADING (degrees).

FLY HEADING (degrees).

FLY PRESENT HEADING.

DEPART (fix) HEADING (degrees).

2. The number of degrees, in group form, to turn and the direction of turn, or

PHRASEOLOGY-

TURN (number of degrees) DEGREES LEFT/RIGHT.

3. For NO-GYRO procedures, the type of vector, direction of turn, and when to stop turn.

PHRASEOLOGY-

THIS WILL BE A NO-GYRO VECTOR,

TURN LEFT/RIGHT.

STOP TURN.

b. When initiating a vector, advise the pilot of the purpose.

PHRASEOLOGY-

VECTOR TO (fix or airway).

VECTOR TO INTERCEPT (name of NAVAID) (specified) RADIAL.

VECTOR FOR SPACING.

VECTOR TO FINAL APPROACH COURSE,

or if the pilot does not have knowledge of the type of approach,

VECTOR TO (approach name) FINAL APPROACH COURSE.

NOTE-

Determine optimum routing based on factors such as wind, weather, traffic, pilot requests, noise abatement, adjacent sector requirement, and letters of agreement.

c. Issue with the vector an altitude to maintain and all appropriate altitude restrictions when:

1. The vector will take the aircraft off an assigned procedure which contains altitude instructions, i.e., instrument approach, nonradar DP, FMSP, etc.

2. The previously issued clearance included crossing restrictions.

REFERENCE-

FAAO 7110.65, *Route or Altitude Amendments, Para 4-2-5*

d. If appropriate, advise the pilot what to expect when the vector is completed.

PHRASEOLOGY-

EXPECT TO RESUME (Route, DP, STAR, FMSP, etc.).

NOTE-

You must ensure that the pilot is made aware if he/she is expected to resume a previously issued route procedure.

e. Provide radar navigational guidance until the aircraft is:

1. Established within the airspace to be protected for the nonradar route to be flown, or

2. On a heading that will, within a reasonable distance, intercept the nonradar route to be flown, and

3. Informed of its position unless the aircraft is RNAV, FMS, or DME equipped and being vectored toward a VORTAC/TACAN or waypoint and within the service volume of the NAVAID.

PHRASEOLOGY-

*(Position with respect to course/fix along route),
RESUME OWN NAVIGATION,*

or

*FLY HEADING (degrees). WHEN ABLE, PROCEED
DIRECT (name of fix),*

or

*RESUME (name/number FMSP/DP/transition/STAR/
procedure).*

REFERENCE-

FAAO 7110.65, *Chapter 4, Section 1, NAVAID Use Limitations.*

f. Aircraft instructed to resume a procedure which contains restrictions (DP/STAR/FMSP, etc.) shall be issued/reissued all applicable restrictions or shall be advised to comply with those restrictions.

PHRASEOLOGY-

*RESUME (name/number FMSP/DP/transition/STAR),
COMPLY WITH RESTRICTIONS.*

EXAMPLE-

“Resume the Mudde One Arrival, comply with restrictions.”

“Cleared direct Luxor, resume the Ksino One arrival, comply with restrictions.”

g. Aircraft vectored off an RNAV route shall be recleared to the next waypoint or as requested by the pilot.

h. During stage A operation, update the route of flight in the computer unless an operational advantage is gained and coordination is accomplished.

i. Inform the pilot when a vector will take the aircraft across a previously assigned nonradar route.

PHRASEOLOGY-

*EXPECT VECTOR ACROSS (NAVAID radial)(airway/
route/course) FOR (purpose).*

REFERENCE-

FAAO 7110.65, *Application, Para 7-6-1*

5-6-3. VECTORS BELOW MINIMUM ALTITUDE

Except in en route automated environments in areas where more than 3 miles separation minima is required, you may vector a departing IFR aircraft, or one executing a missed approach, within 40 miles of the antenna and before it reaches the minimum altitude for IFR operations if separation from prominent obstructions shown on the radar scope is applied in accordance with the following:

a. If the flight path is 3 miles or more from the obstruction and the aircraft is climbing to an altitude at least 1,000 feet above the obstruction, vector the aircraft to maintain at least 3 miles separation from the obstruction until the aircraft reports leaving an altitude above the obstruction.

b. If the flight path is less than 3 miles from the obstruction, and the aircraft is climbing to an altitude at least 1,000 feet above the obstruction, vector the aircraft to increase lateral separation from the obstruction until the 3 mile minimum is achieved or until the aircraft reports leaving an altitude above the obstruction.

c. At those locations where diverse vector areas (DVA) have been established, terminal radar facilities may vector aircraft below the MVA/MIA within those areas and along those routes described in facility directives.

REFERENCE-

FAAO 7210.3, *Establishing Diverse Vector Area/s (DVA), Para 3-9-5.*

Section 7. Speed Adjustment

5-7-1. APPLICATION

Keep speed adjustments to the minimum necessary to achieve or maintain required or desired spacing. Avoid adjustments requiring alternate decreases and increases. Permit pilots to resume normal speed when previously specified adjustments are no longer needed.

NOTE-

It is the pilot's responsibility and prerogative to refuse speed adjustment that he/she considers excessive or contrary to the aircraft's operating specifications.

a. Consider the following when applying speed control:

1. Determine the interval required and the point at which the interval is to be accomplished.

2. Implement speed adjustment based on the following principles.

(a) Priority of speed adjustment instructions is determined by the relative speed and position of the aircraft involved and the spacing requirement.

(b) Speed adjustments are not achieved instantaneously. Aircraft configuration, altitudes, and speed determine the time and distance required to accomplish the adjustment.

3. Use the following techniques in speed control situations:

(a) Compensate for compression when assigning air speed adjustment in an in-trail situation by using one of the following techniques:

(1) Reduce the trailing aircraft first.

(2) Increase the leading aircraft first.

(b) Assign a specific airspeed if required to maintain spacing.

(c) Allow increased time and distance to achieve speed adjustments in the following situations:

(1) Higher altitudes.

(2) Greater speed.

(3) Clean configurations.

(d) Ensure that aircraft are allowed to operate in a clean configuration as long as circumstances permit.

(e) Keep the number of speed adjustments per aircraft to the minimum required to achieve and maintain spacing.

b. Do not assign speed adjustment to aircraft:

1. At or above FL 390 without pilot consent.

2. Executing a published high altitude instrument approach procedure.

3. In a holding pattern.

REFERENCE-

FAAO 7110.65, Holding Instructions, Para 4-6-4

4. Inside the final approach fix on final or a point 5 miles from the runway, whichever is closer to the runway.

c. At the time approach clearance is issued, previously issued speed adjustments shall be restated if required.

d. Approach clearances cancel any previously assigned speed adjustment. Pilots are expected to make their own speed adjustments to complete the approach unless the adjustments are restated.

e. Express speed adjustments in terms of knots based on indicated airspeed (IAS) in 10-knot increments. At or above FL 240, speeds may be expressed in terms of Mach numbers in 0.01 increments for turbojet aircraft with Mach meters (i.e., Mach 0.69, 0.70, 0.71, etc.).

NOTE-

1. *Pilots complying with speed adjustment instructions should maintain a speed within plus or minus 10 knots or 0.02 Mach number of the specified speed.*

2. *When assigning speeds to achieve spacing between aircraft at different altitudes, consider that ground speed may vary with altitude. Further speed adjustment may be necessary to attain the desired spacing.*

REFERENCE-

FAAO 7110.65, Methods, Para 5-7-2

5-7-2. METHODS**a.** Instruct aircraft to:

1. Maintain present/specific speed.
2. Maintain specified speed or greater/less.
3. Maintain the highest/lowest practical speed.
4. Increase or reduce to a specified speed or by a specified number of knots.

**PHRASEOLOGY—
SAY AIRSPEED.***SAY MACH NUMBER.**MAINTAIN PRESENT SPEED.**MAINTAIN (specific speed) KNOTS.**MAINTAIN (specific speed) KNOTS OR GREATER.**DO NOT EXCEED (speed) KNOTS.**MAINTAIN MAXIMUM FORWARD SPEED.**MAINTAIN SLOWEST PRACTICAL SPEED.***INCREASE/REDUCE SPEED:***TO (specified speed in knots),**or**TO MACH (Mach number),**or**(number of knots) KNOTS.***EXAMPLE—***“Increase speed to Mach point seven two.”**“Reduce speed to two five zero.”**“Reduce speed twenty knots.”**“Maintain two eight zero knots.”**“Maintain maximum forward speed.”***NOTE—**

1. A pilot operating at or above 10,000 feet MSL on an assigned speed adjustment greater than 250 knots is expected to comply with 14 CFR Section 91.117(a) when cleared below 10,000 feet MSL, within domestic airspace, without notifying ATC. Pilots are expected to comply with the other provisions of 14 CFR Section 91.117 without notification.

2. Speed restrictions of 250 knots do not apply to aircraft operating beyond 12 NM from the coastline within the U.S. Flight Information Region, in offshore Class E airspace below 10,000 feet MSL. However, in airspace underlying a Class B airspace area designated for an airport, or in a VFR corridor designated through such as a Class B airspace area, pilots are expected to comply with the 200 knot speed limit specified in 14 CFR Section 91.117(c). (See 14 CFR Sections 91.117(c) and 91.703.)

3. The phrases “maintain maximum forward speed” and “maintain slowest practical speed” are primarily intended for use when sequencing a group of aircraft. As the sequencing plan develops, it may be necessary to determine the specific speed and/or make specific speed assignments.

b. To obtain pilot concurrence for a speed adjustment at or above FL 390, as required by para 5-7-1, Application, use the following phraseology.

PHRASEOLOGY—*(Speed adjustment), IF UNABLE ADVISE.***EXAMPLE—***“Reduce speed to one niner zero, if unable advise.”*

c. Simultaneous speed reduction and descent can be extremely difficult, particularly for turbojet aircraft. Specifying which action is to be accomplished first removes any doubt the pilot may have as to controller intent or priority. Specify which action is expected first when combining speed reduction with a descent clearance.

1. Speed reductions prior to descent.**PHRASEOLOGY—****REDUCE SPEED:***TO (specified speed),**or**(number of knots) KNOTS.**THEN, DESCEND AND MAINTAIN (altitude).***2.** Speed reduction following descent.**PHRASEOLOGY—****DESCEND AND MAINTAIN (altitude).****THEN, REDUCE SPEED:***TO (specified speed in knots),**or*

TO MACH (Mach number),

or

(number of knots) KNOTS.

NOTE-

When specifying descent prior to speed reduction, consider the maximum speed requirements specified in 14 CFR Section 91.117. It may be necessary for the pilot to level off temporarily and reduce speed prior to descending below 10,000 feet MSL.

d. Specify combined speed/altitude fix crossing restrictions.

PHRASEOLOGY-

CROSS (fix) AT AND MAINTAIN (altitude) AT (specified speed) KNOTS.

EXAMPLE-

“Cross Robinsville at and maintain six thousand at two three zero knots.”

REFERENCE-

FAAO 7110.65, Numbers Usage, Para 2-4-17
FAAO 7110.65, Altitude Information, Para 4-5-7

5-7-3. MINIMA

When assigning airspeeds, use the following recommended minima:

a. To aircraft operating between FL 280 and 10,000 feet, a speed not less than 250 knots or the equivalent Mach number.

NOTE-

1. On a standard day the Mach numbers equivalent to 250 knots CAS (subject to minor variations) are:

FL 240-0.6

FL 250-0.61

FL 260-0.62

FL 270-0.64

FL 280-0.65

FL 290-0.66.

2. If a pilot is unable to comply with the speed assignment, the pilot will advise.

b. When an operational advantage will be realized, speeds lower than the recommended minima may be applied.

c. To arrival aircraft operating below 10,000 feet:

1. Turbojet aircraft. A speed not less than 210 knots; except when the aircraft is within 20 flying miles of the runway threshold of the airport of intended landing, a speed not less than 170 knots.

2. Reciprocating engine and turboprop aircraft. A speed not less than 200 knots; except when the aircraft is within 20 flying miles of the runway threshold of the airport of intended landing, a speed not less than 150 knots.

d. Departures:

1. Turbojet aircraft. A speed not less than 230 knots.

2. Reciprocating engine and turboprop aircraft. A speed not less than 150 knots.

e. Helicopters. A speed not less than 60 knots.

REFERENCE-

FAAO 7110.65, Methods, Para 5-7-2

5-7-4. TERMINATION

Advise aircraft when speed adjustment is no longer needed.

PHRASEOLOGY-

RESUME NORMAL SPEED.

NOTE-

An instruction to “resume normal speed” does not delete speed restrictions that are applicable to published procedures of upcoming segments of flight, unless specifically stated by ATC. This does not relieve the pilot of those speed restrictions which are applicable to 14 CFR Section 91.117.

Section 8. Radar Departures

5-8-1. PROCEDURES

Use standard departure routes and channelized altitudes whenever practical to reduce coordination. Do not, however, assign these routes solely to provide for possible radar or communication failure.

5-8-2. INITIAL HEADING

Before departure, assign the initial heading to be flown if a departing aircraft is to be vectored immediately after takeoff.

PHRASEOLOGY-

FLY RUNWAY HEADING.

TURN LEFT/RIGHT, HEADING (degrees).

NOTE-

TERMINAL. A purpose for the heading is not necessary, since pilots operating in a radar environment associate assigned headings with vectors to their planned route of flight.

REFERENCE-

FAAO 7110.65, Departure Clearances, Para 4-3-2

FAAO 7110.65, Vectors Below Minimum Altitude, Para 5-6-3

5-8-3. SUCCESSIVE OR SIMULTANEOUS DEPARTURES

TERMINAL

Separate aircraft departing from the same airport/heliport or adjacent airports/heliports in accordance with the following minima provided radar identification with the aircraft will be established within 1 mile of the takeoff runway end/helipad and courses will diverge by 15 degrees or more.

NOTE-

1. FAAO 8260.19, Flight Procedures and Airspace, establishes guidelines for IFR departure turning procedures which assumes a climb to 400 feet above the airport elevation before a turn is commenced. FAAO 8260.3, United States Standard for Terminal Instrument Procedures (TERPS), the ILS missed approach criteria, requires a straight climb of 400 feet be specified where turns greater than 15 degrees are required.

2. Consider known aircraft performance characteristics when applying initial separation to successive departing aircraft.

3. When one or both of the departure surfaces is a helipad, use the takeoff course of the helicopter as a reference, comparable to the centerline of a runway and the helipad center as the threshold.

a. Between aircraft departing the same runway/helipad or parallel runways/helicopter takeoff courses separated by less than 2,500 feet— 1 mile if courses diverge immediately after departure. (See FIG 5-8-1, FIG 5-8-2, and FIG 5-8-3.)

FIG 5-8-1

Successive Departures

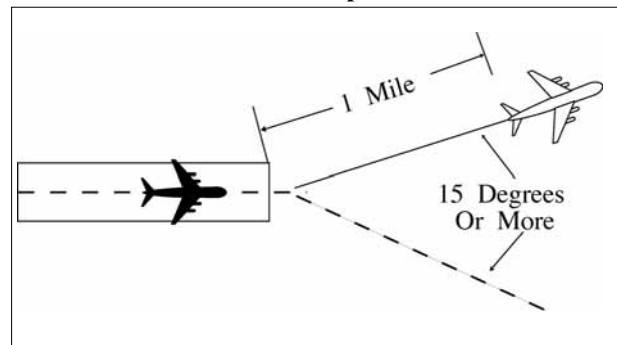

FIG 5-8-2

Simultaneous Departures

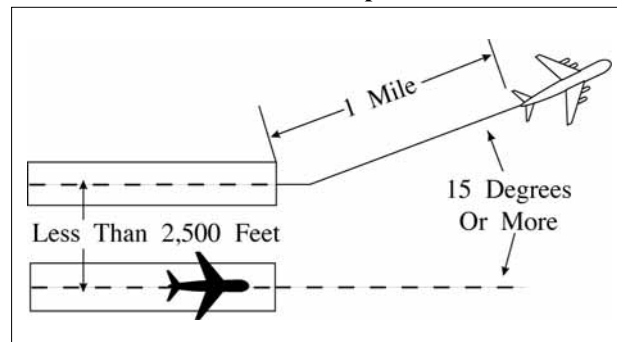
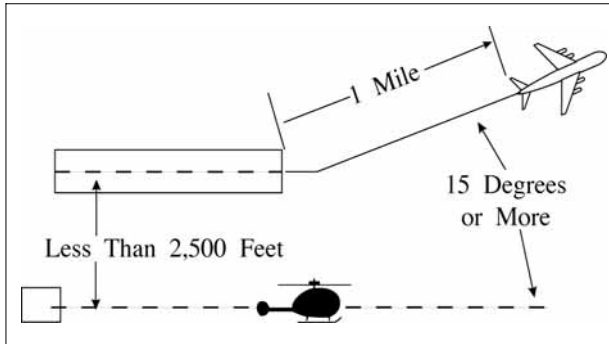

FIG 5-8-3

Simultaneous Departures



NOTE-

This procedure does not apply when a small aircraft is taking off from an intersection on the same runway behind a large aircraft or when an aircraft is departing behind a heavy jet/B757.

REFERENCE-

FAAO 7110.65, Wake Turbulence Separation for Intersection Departures, Para 3-9-7
 FAAO 7110.65, Intersecting Runway Separation, Para 3-9-8
 FAAO 7110.65, Minima, Para 5-5-4

b. Between aircraft departing from diverging runways:

1. Nonintersecting runways. Authorize simultaneous takeoffs if runways diverge by 15 degrees or more. (See FIG 5-8-4.)

FIG 5-8-4

Nonintersecting Runway Departures

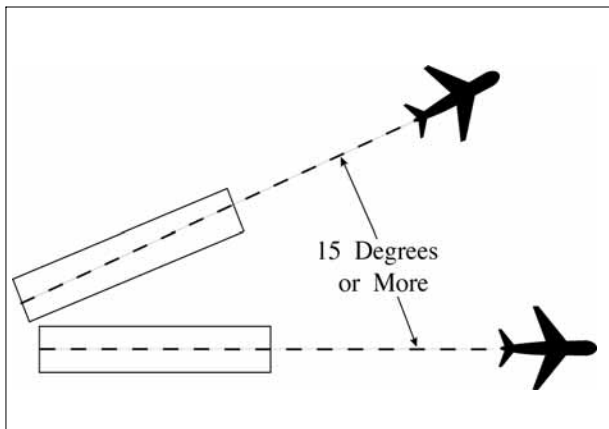

2. Intersecting runways and/or helicopter take-off courses which diverge by 15 degrees or more. Authorize takeoff of a succeeding aircraft when the preceding aircraft has passed the point of runway and/or takeoff course intersection. When applicable, apply the procedure in para 3-9-5, Anticipating Separation. (See FIG 5-8-5 and FIG 5-8-6.)

FIG 5-8-5

Intersecting Runway Departures

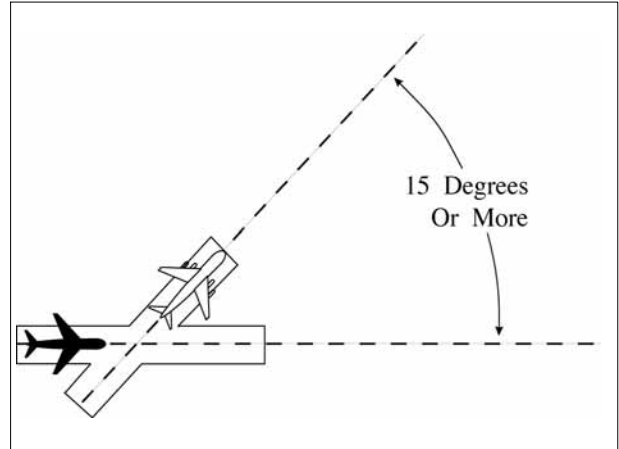

NOTE-

This procedure does not apply when aircraft are departing behind a heavy jet/B757.

FIG 5-8-6

Intersecting Helicopter Course Departures

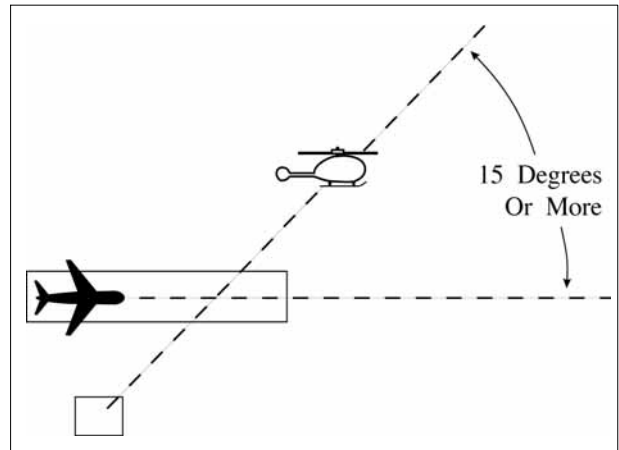

c. Between aircraft departing in the same direction from parallel runways/helicopter takeoff courses. Authorize simultaneous takeoffs if the centerlines/takeoff courses are separated by at least 2,500 feet and courses diverge by 15 degrees or more immediately after departure. (See FIG 5-8-7 and FIG 5-8-8.)

FIG 5-8-7

Parallel Runway Departures

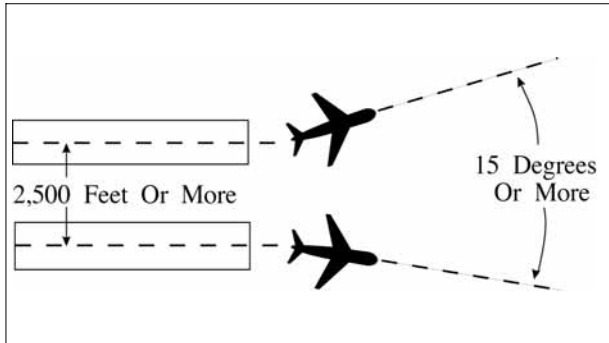
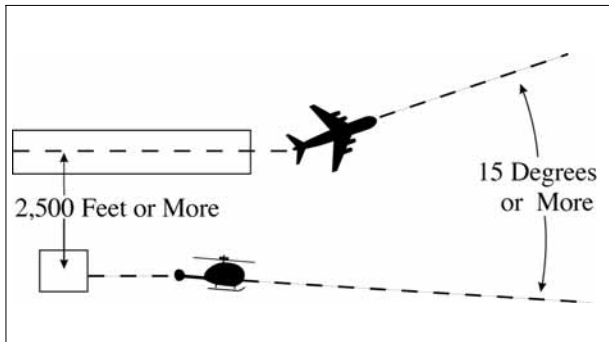

FIG 5-8-8

Parallel Helicopter Course Departures



5-8-4. DEPARTURE AND ARRIVAL

TERMINAL. Except as provided in para 5-8-5, Departures and Arrivals on Parallel or Nonintersecting Diverging Runways, separate a departing aircraft from an arriving aircraft on final approach by a minimum of 2 miles if separation will increase to a minimum of 3 miles (5 miles when 40 miles or more from the antenna) within 1 minute after takeoff.

NOTE-

1. This procedure permits a departing aircraft to be released so long as an arriving aircraft is no closer than 2 miles from the runway at the time. This separation is determined at the time the departing aircraft commences takeoff roll.

2. Consider the effect surface conditions, such as ice, snow, and other precipitation, may have on known aircraft performance characteristics, and the influence these conditions may have on the pilot's ability to commence takeoff roll in a timely manner.

5-8-5. DEPARTURES AND ARRIVALS ON PARALLEL OR NONINTERSECTING DIVERGING RUNWAYS

TERMINAL. Authorize simultaneous operations between an aircraft departing on a runway and an aircraft on final approach to another parallel or nonintersecting diverging runway if the departure course diverges immediately by at least 30 degrees from the missed approach course until separation is applied and provided one of the following conditions are met:

NOTE-

When one or both of the takeoff/landing surfaces is a helipad, consider the helicopter takeoff course as the runway centerline and the helipad center as the threshold.

a. When parallel runway thresholds are even, the runway centerlines are at least 2,500 feet apart. (See FIG 5-8-9 and FIG 5-8-10.)

FIG 5-8-9

Parallel Thresholds are Even

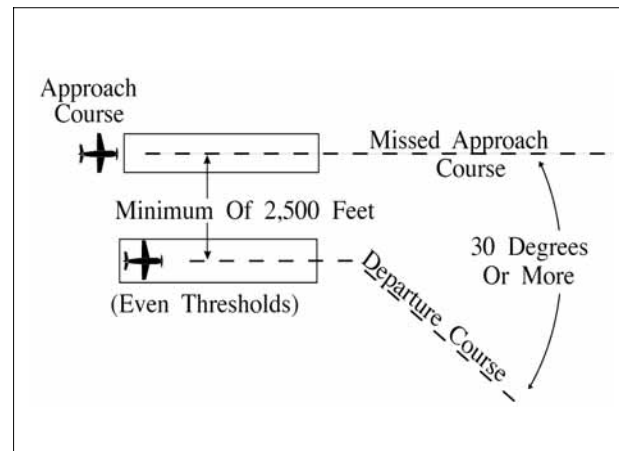

FIG 5-8-10

Parallel Thresholds are Even

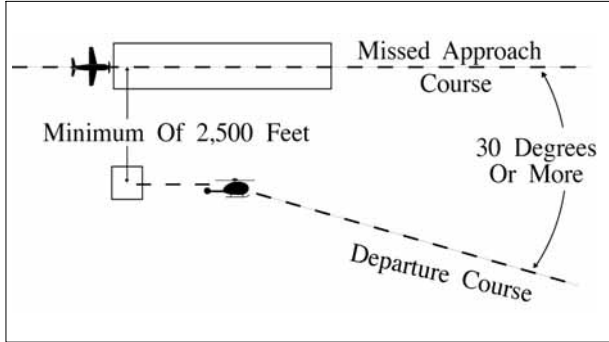
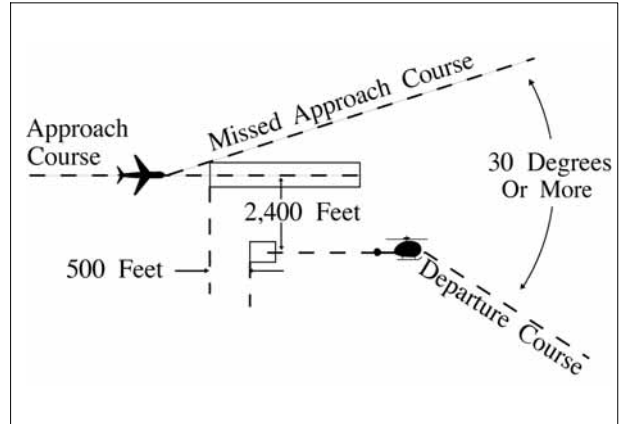

FIG 5-8-12

Parallel Thresholds are Staggered



b. When parallel runway thresholds are staggered and:

1. The arriving aircraft is approaching the nearer runway: the centerlines are at least 1,000 feet apart and the landing thresholds are staggered at least 500 feet for each 100 feet less than 2,500 the centerlines are separated. (See FIG 5-8-11 and FIG 5-8-12.)

NOTE-

In the event of a missed approach by a heavy jet/B757, apply the procedures in para 3-9-6 Same Runway Separation, or para 3-9-8 Intersecting Runway Separation, ensure that the heavy jet does not overtake or cross in front of an aircraft departing from the adjacent parallel runway.

2. The arriving aircraft is approaching the farther runway: the runway centerlines separation exceeds 2,500 feet by at least 100 feet for each 500 feet the landing thresholds are staggered. (See FIG 5-8-13.)

FIG 5-8-11

Parallel Thresholds are Staggered

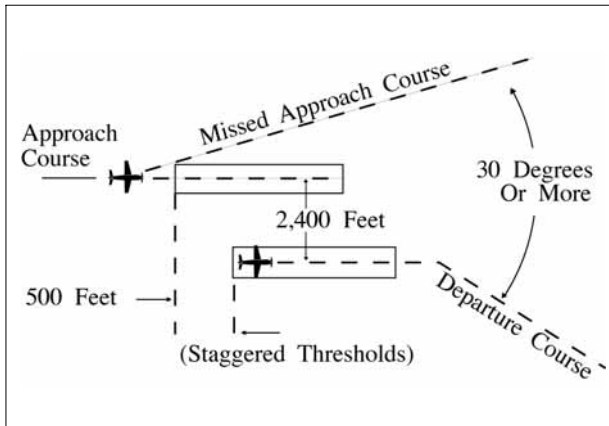
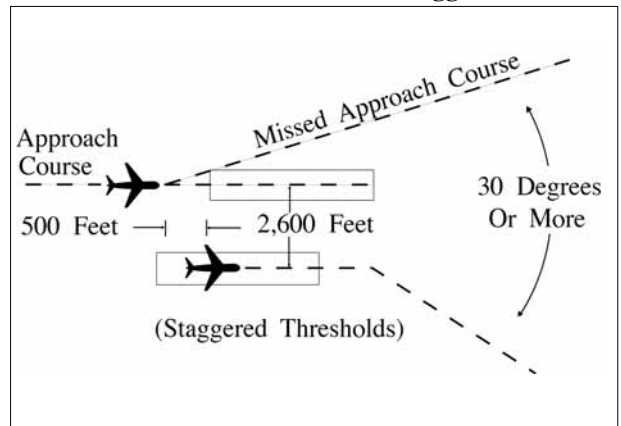

FIG 5-8-13

Parallel Thresholds are Staggered



c. When nonintersecting runways diverge by 15 degrees or more and runway edges do not touch. (See FIG 5-8-14.)

FIG 5-8-14

Diverging Nonintersecting Runways

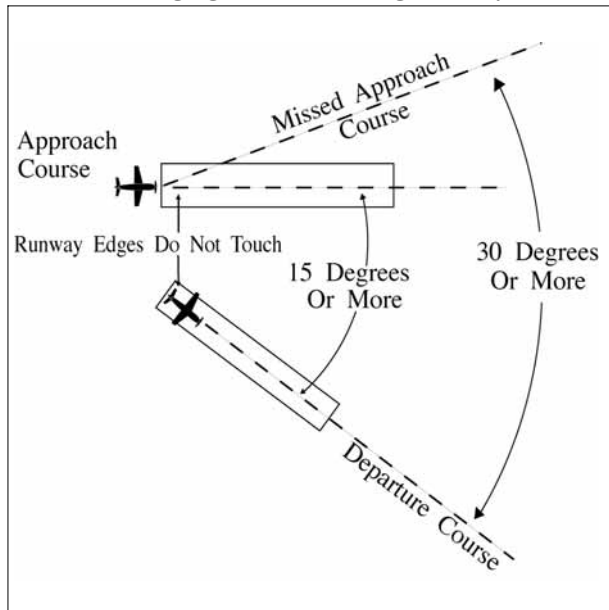

d. When the aircraft on takeoff is a helicopter, hold the helicopter until visual separation is possible or apply the separation criteria in subparas a, b, or c.

REFERENCE-

FAAO 7110.65, *Departure and Arrival, Para 5-8-4*

Section 9. Radar Arrivals

5-9-1. VECTORS TO FINAL APPROACH COURSE

Except as provided in para 7-4-2, Vectors for Visual Approach, vector arriving aircraft to intercept the final approach course:

a. At least 2 miles outside the approach gate unless one of the following exists:

1. When the reported ceiling is at least 500 feet above the MVA/MIA and the visibility is at least 3 miles (report may be a PIREP if no weather is reported for the airport), aircraft may be vectored to intercept the final approach course closer than 2 miles outside the approach gate but no closer than the approach gate.

2. If specifically requested by the pilot, aircraft may be vectored to intercept the final approach course inside the approach gate but no closer than the final approach fix.

EXCEPTION. Conditions 1 and 2 above do not apply to RNAV aircraft being vectored for a GPS or RNAV approach.

b. For a precision approach, at an altitude not above the glideslope/glidepath or below the minimum glideslope intercept altitude specified on the approach procedure chart.

c. For a nonprecision approach, at an altitude which will allow descent in accordance with the published procedure.

NOTE-

A pilot request for an "evaluation approach," or a "coupled approach," or use of a similar term, indicates the pilot desires the application of subparagraphs a and b.

d. **EN ROUTE.** The following provisions are required before an aircraft may be vectored to the final approach course:

1. The approach gate and a line (solid or broken), depicting the final approach course starting at or passing through the approach gate and extending away from the airport, be displayed on the radar scope; for a precision approach, the line length shall extend at least the maximum range of the localizer; for a nonprecision approach, the line length shall extend at least 10NM outside the approach gate; and

2. The maximum range selected on the radar display is 150 NM; or

3. An adjacent radar display is set at 125 NM or less, configured for the approach in use, and is utilized for the vector to the final approach course.

4. If unable to comply with subparagraphs 1, 2, or 3 above, issue the clearance in accordance with para 4-8-1, Approach Clearance.

REFERENCE-

FAAO 7110.65, Approach Clearance, Para 4-8-1

FAAO 7110.65, Final Approach Course Interception, Para 5-9-2

5-9-2. FINAL APPROACH COURSE INTERCEPTION

a. Assign headings that will permit final approach course interception on a track that does not exceed the interception angles specified in TBL 5-9-1.

TBL 5-9-1

Approach Course Interception Angle

Distance from interception point to approach gate	Maximum interception angle
Less than 2 miles or triple simultaneous ILS/MLS approaches in use	20 degrees
2 miles or more	30 degrees (45 degrees for helicopters)

b. If deviations from the final approach course are observed after initial course interception, apply the following:

1. Outside the approach gate: apply procedures in accordance with subpara a, if necessary, vector the aircraft for another approach.

2. Inside the approach gate: inform the pilot of the aircraft's position and ask intentions.

PHRASEOLOGY-

(Ident) (distance) MILE(S) FROM THE AIRPORT, (distance) MILE(S) RIGHT/LEFT OF COURSE, SAY INTENTIONS.

NOTE-

The intent is to provide for a track course intercept angle judged by the controller to be no greater than specified by this procedure.

REFERENCE-

FAAO 7110.65, Chapter 5, Section 9, Radar Arrivals, and Section 10, Radar Approaches- Terminal.

c. *EN ROUTE.* When using a radar scope range above 125 NM, the controller shall solicit and receive a pilot report that the aircraft is established on the final approach course. If the pilot has not reported established by the final approach gate, inform the pilot of his/her observed position and ask intentions.

NOTE-
It may be difficult to accurately determine small distances when using very large range settings.

5-9-3. VECTORS ACROSS FINAL APPROACH COURSE

Inform the aircraft whenever a vector will take it across the final approach course and state the reason for such action.

NOTE-
In the event you are unable to so inform the aircraft, the pilot is not expected to turn inbound on the final approach course unless approach clearance has been issued.

PHRASEOLOGY-
EXPECT VECTORS ACROSS FINAL FOR (purpose).

EXAMPLE-
“EXPECT VECTORS ACROSS FINAL FOR SPACING.”

REFERENCE-
FAAO 7110.65, Final Approach Course Interception, Para 5-9-2

5-9-4. ARRIVAL INSTRUCTIONS

Issue all of the following to an aircraft before it reaches the approach gate:

- a. Position relative to a fix on the final approach course. If none is portrayed on the radar display or if none is prescribed in the procedure, issue position information relative to the navigation aid which provides final approach guidance or relative to the airport.
- b. Vector to intercept the final approach course if required.
- c. Approach clearance except when conducting a radar approach. Issue approach clearance only after the aircraft is:

- 1. Established on a segment of a published route or instrument approach procedure, or see FIG 5-9-1 Example 1.

FIG 5-9-1
Arrival Instructions

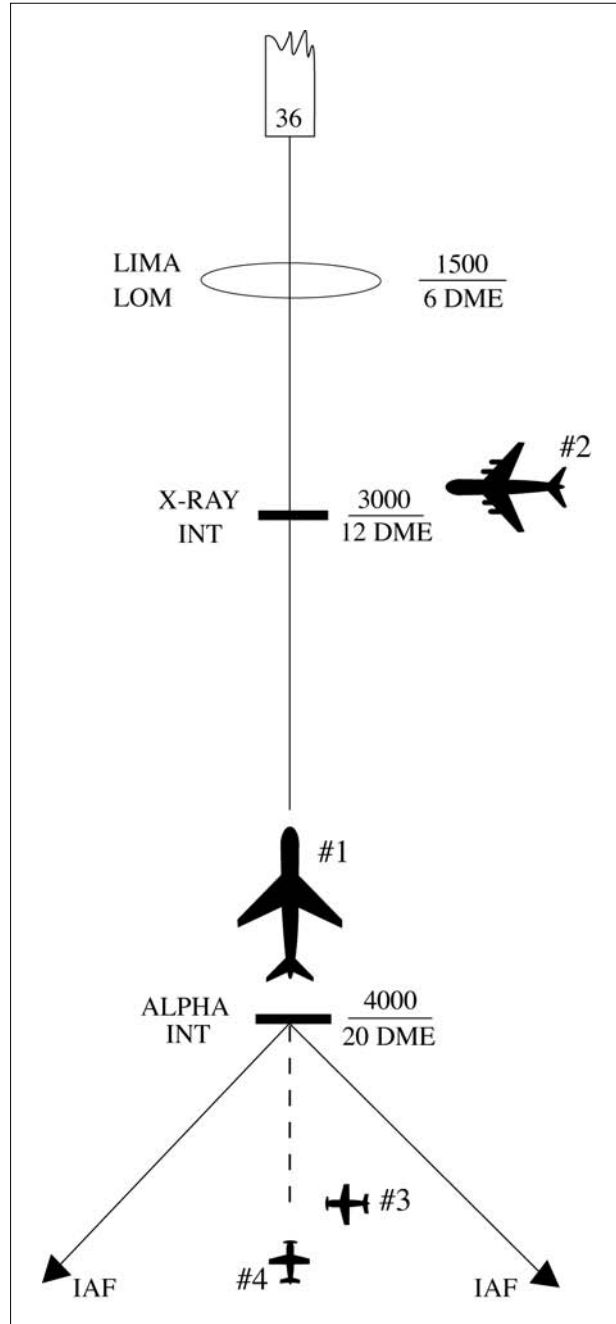

EXAMPLE-

1. Aircraft 1 was vectored to the final approach course but clearance was withheld. It is now at 4,000 feet and established on a segment of the instrument approach procedure. "Seven miles from X-RAY. Cleared I-L-S runway three six approach." (See FIG 5-9-1.)

2. Aircraft 2 is being vectored to a published segment of the final approach course, 4 miles from LIMA at 2,000 feet. The MVA for this area is 2,000 feet. "Four miles from LIMA. Turn right heading three four zero. Maintain two thousand until established on the localizer. Cleared I-L-S runway three six approach." (See FIG 5-9-1.)

3. Aircraft 3 is being vectored to intercept the final approach course beyond the approach segments, 5 miles from Alpha at 5,000 feet. the MVA for this area is 4,000 feet. "Five miles from Alpha. Turn right heading three three zero. Cross Alpha at or above four thousand. Cleared I-L-S runway three six approach." (See FIG 5-9-1.)

4. Aircraft 4 is established on the final approach course beyond the approach segments, 8 miles from Alpha at 6,000 feet. The MVA for this area is 4,000 feet. "Eight miles from Alpha. Cross Alpha at or above four thousand. Cleared I-L-S runway three six approach." (See FIG 5-9-1.)

2. Assigned an altitude to maintain until the aircraft is established on a segment of a published route or instrument approach procedure. (See FIG 5-9-2 thru FIG 5-9-4.)

FIG 5-9-2

Arrival Instructions

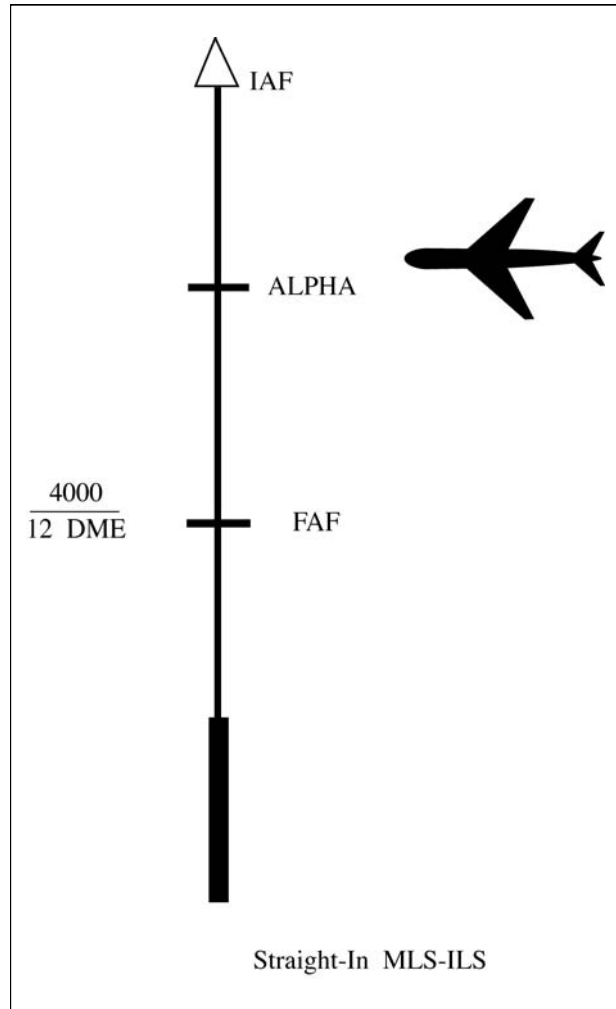

EXAMPLE-

The aircraft is being vectored to a published segment of the MLS final approach course, 3 miles from Alpha at 4,000 feet. The MVA for this area is 4,000 feet. "Three miles from Alpha. Turn left heading two one zero. Maintain four thousand until established on the azimuth course. Cleared M-L-S runway one eight approach." (See FIG 5-9-2.)

FIG 5-9-3

Arrival Instructions

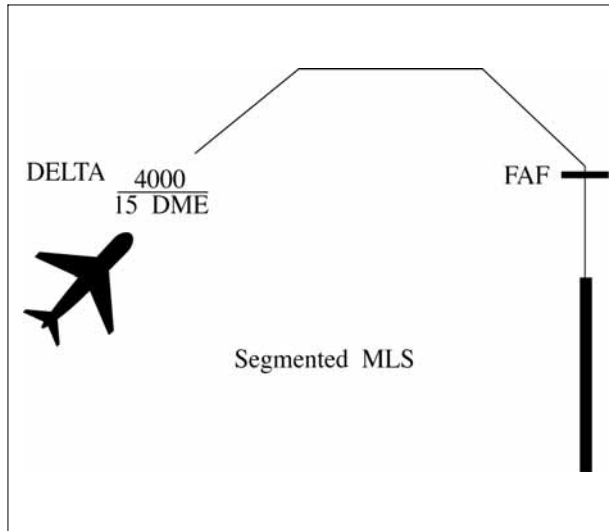
**EXAMPLE-**

The aircraft is en route to Delta waypoint at 6,000 feet. The MVA for this area is 4,000 feet. "Cross Delta at or above four thousand. Cleared M-L-S runway one eight approach." (See FIG 5-9-3.)

FIG 5-9-4

Arrival Instructions

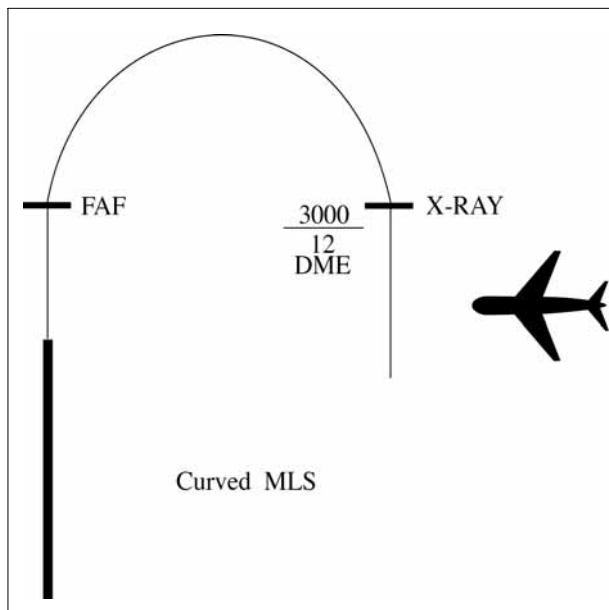
**EXAMPLE-**

The aircraft is being vectored to an MLS curved approach, 3 miles from X-ray at 3,000 feet. "Three miles from X-ray. Turn right heading three three zero. Maintain three thousand until established on the azimuth course. Cleared M-L-S runway one eight approach." (See FIG 5-9-4.)

NOTE-

1. The altitude assigned must assure IFR obstruction clearance from the point at which the approach clearance is issued until established on a segment of a published route or instrument approach procedure.

2. If the altitude assignment is VFR-on-top, it is conceivable that the pilot may elect to remain high until arrival over the final approach fix which may require the pilot to circle to descend so as to cross the final approach fix at an altitude that would permit landing.

d. Instructions to do one of the following:

NOTE-

The principal purpose of this paragraph is to ensure that frequency changes are made prior to passing the final approach fix. However, at times it will be desirable to retain an aircraft on the approach control frequency to provide a single-frequency approach or other radar services. When this occurs, it will be necessary to relay tower clearances or instructions to preclude changing frequencies prior to landing or approach termination.

1. Monitor local control frequency, reporting to the tower when over the approach fix.

2. Contact the tower on local control frequency.

REFERENCE-

FAAO 7110.65, Communications Release, Para 4-8-8

3. Contact the final controller on the appropriate frequency if radar service will be provided on final on a different frequency.

REFERENCE-

FAAO 7110.65, Final Controller Changeover, Para 5-10-8

4. When radar is used to establish the final approach fix, inform the pilot that after being advised that he/she is over the fix he/she is to contact the tower on local control frequency.

EXAMPLE-

"Three miles from final approach fix. Turn left heading zero one zero. Maintain two thousand until established on the localizer. Cleared I-L-S runway three six approach. I will advise when over the fix."

"Over final approach fix. Contact tower one one eight point one."

NOTE-

ARSR may be used for establishment of initial approach and intermediate approach fixes only. ASR must be used to establish the final approach fix.

REFERENCE-

FAAO 7110.65, *Final Approach Course Interception, Para 5-9-2*
 FAAO 7110.65, *Simultaneous Independent ILS/MLS Approaches-Dual & Triple, Para 5-9-7*

e. Where a Terminal Arrival Area (TAA) has been established to support RNAV approaches, inform the aircraft of its position relative to the appropriate IAF and issue the approach clearance. (See FIG 5-9-5.)

EXAMPLE-

1. *Aircraft 1: The aircraft is in the straight in area of the TAA. "Seven miles from CENTR, Cleared R-NAV Runway One Eight Approach."*

2. *Aircraft 2: The aircraft is in the left base area of the TAA. "Fifteen miles from LEFTT, Cleared GPS Runway One Eight Approach."*

3. *Aircraft 3: The aircraft is in the right base area of the TAA. "Four miles from WRITE, Cleared FMS Runway One Eight Approach."*

5-9-5. APPROACH SEPARATION RESPONSIBILITY

a. The radar controller performing the approach control function is responsible for separation of radar arrivals unless visual separation is provided by the tower, or a letter of agreement/facility directive authorizes otherwise. Radar final controllers ensure that established separation is maintained between aircraft under their control and other aircraft established on the same final approach course.

NOTE-

The radar controller may be a controller in an ARTCC, a terminal facility, or a tower controller when authorized to perform the approach control function in a terminal area.

REFERENCE-

FAAO 7110.65, *Wake Turbulence, Para 2-1-19*
 FAAO 7110.65, *Section 5, Radar Separation, Application, Para 5-5-1*
 FAAO 7110.65, *Visual Separation, Para 7-2-1*
 FAAO 7110.65, *Minima, Para 5-5-4*
 FAAO 7210.3, *Authorization for Separation Services by Towers, Para 2-1-15.*

b. When timed approaches are being conducted, the radar controller shall maintain the radar separation specified in para 6-7-5, Interval Minima, until the aircraft is observed to have passed the final approach fix inbound (nonprecision approaches) or the OM or the fix used in lieu of the outer marker (precision approaches) and is within 5 miles of the runway on the final approach course or until visual separation can be provided by the tower.

REFERENCE-

FAAO 7110.65, *Receiving Controller Handoff, Para 5-4-6*
 FAAO 7110.65, *Final Approach Course Interception, Para 5-9-2*
 FAAO 7110.65, *Parallel Dependent ILS/MLS Approaches, Para 5-9-6*
 FAAO 7110.65, *Approach Sequence, Para 6-7-2*

5-9-6. PARALLEL DEPENDENT ILS/MLS APPROACHES

TERMINAL

a. Apply the following minimum separation when conducting parallel dependent ILS, MLS, or ILS and MLS approaches:

1. Provide a minimum of 1,000 feet vertical or a minimum of 3 miles radar separation between aircraft during turn on.

2. Provide a minimum of 1.5 miles radar separation diagonally between successive aircraft on adjacent localizer/azimuth courses when runway centerlines are at least 2,500 feet but no more than 4,300 feet apart.

FIG 5-9-5
Basic "T" Design

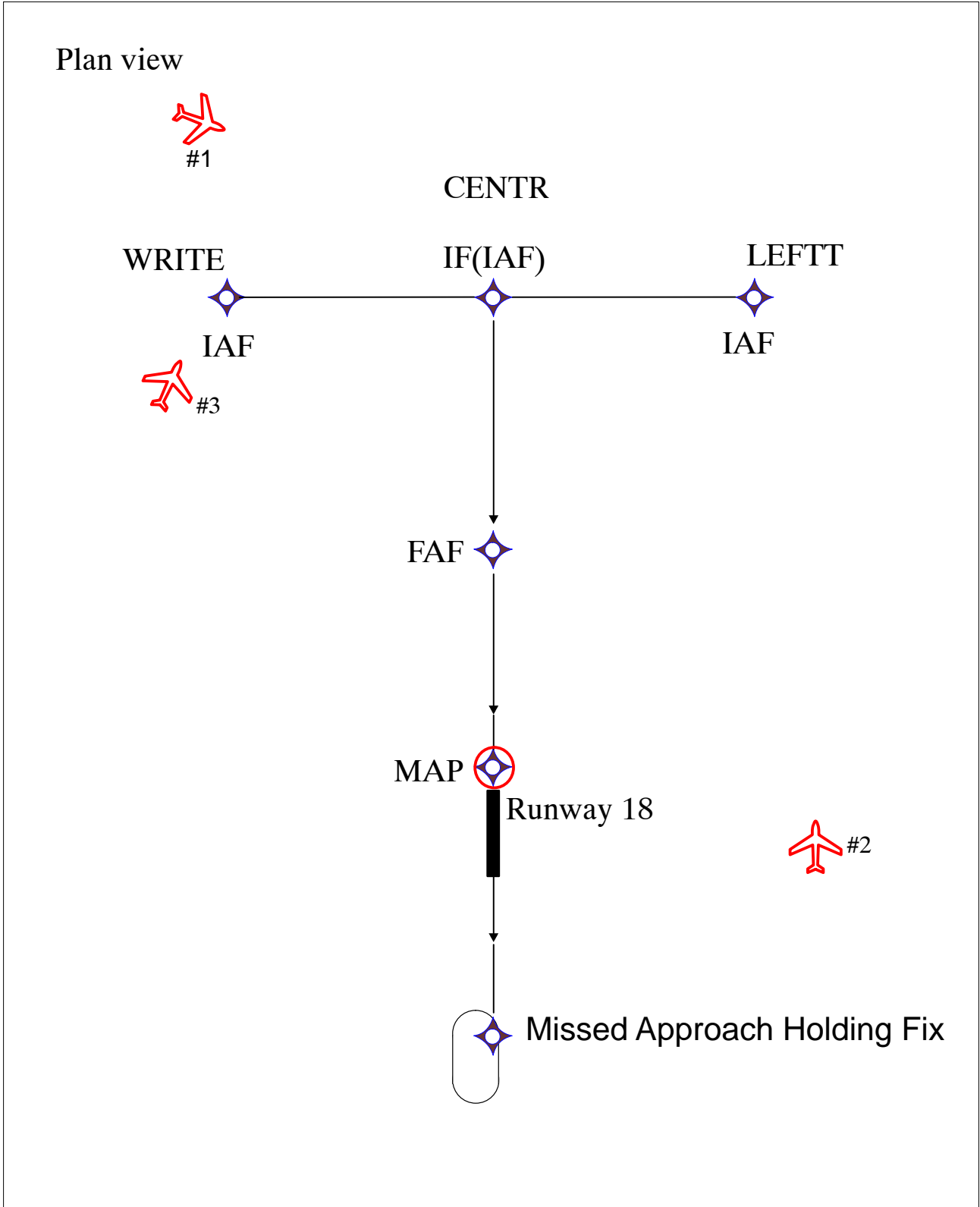
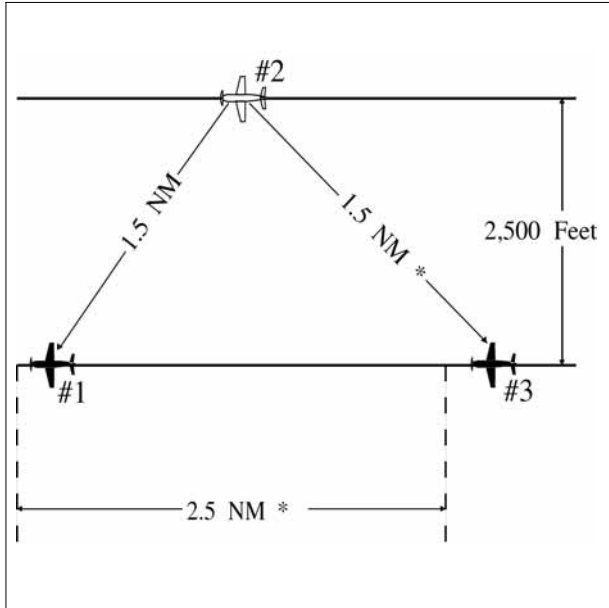

FIG 5-9-6

Parallel Dependent ILS/MLS Approaches



EXAMPLE-

In FIG 5-9-6, Aircraft 2 is 1.5 miles from Aircraft 1, and Aircraft 3 is 1.5 miles or more from Aircraft 2. The resultant separation between Aircrafts 1 and 3 is at least 2.5 miles.

3. Provide a minimum of 2 miles radar separation diagonally between successive aircraft on adjacent localizer/azimuth courses where runway centerlines are more than 4,300 feet but no more than 9,000 feet apart.

FIG 5-9-7

Parallel Dependent ILS/MLS Approaches

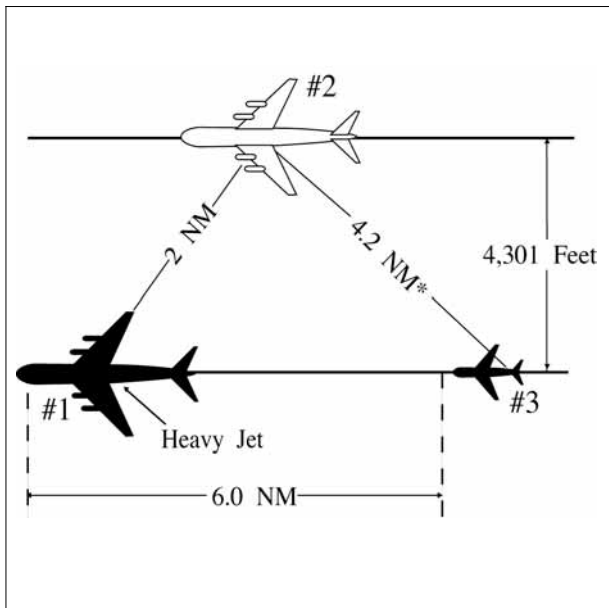

EXAMPLE-

In FIG 5-9-7, Aircraft 2 is 2 miles from heavy Aircraft 1. Aircraft 3 is a small aircraft and is 6 miles from Aircraft 1. *The resultant separation between Aircrafts 2 and 3 is 4.2 miles.

4. Provide the minimum applicable radar separation between aircraft on the same final approach course.

REFERENCE-

FAAO 7110.65, Section 5, Radar Separation, Minima, Para 5-5-4

b. The following conditions are required when applying the minimum radar separation on adjacent localizer/azimuth courses allowed in subpara a:

1. Apply this separation standard only after aircraft are established on the parallel final approach course.

2. Straight-in landings will be made.

3. Missed approach procedures do not conflict.

4. Aircraft are informed that approaches to both runways are in use. This information may be provided through the ATIS.

5. Approach control shall have the interphone capability of communicating directly with the local controller at locations where separation responsibility has not been delegated to the tower.

NOTE-

The interphone capability is an integral part of this procedure when approach control has the sole separation responsibility.

REFERENCE-

FAAO 7110.65, Approach Separation Responsibility, Para 5-9-5
FAAO 7210.3, Authorization for Separation Services by Towers, Para 2-1-15.

c. Consideration should be given to known factors that may in any way affect the safety of the instrument approach phase of flight, such as surface wind direction and velocity, wind shear alerts/reports, severe weather activity, etc. Closely monitor weather activity that could impact the final approach course. Weather conditions in the vicinity of the final approach course may dictate a change of approach in use.

REFERENCE-

FAAO 7110.65, Final Approach Course Interception, Para 5-9-2

5-9-7. SIMULTANEOUS INDEPENDENT ILS/MLS APPROACHES- DUAL & TRIPLE

TERMINAL

a. Apply the following minimum separation when conducting simultaneous independent ILS, MLS, or ILS and MLS approaches:

1. Provide a minimum of 1,000 feet vertical or a minimum of 3 miles radar separation between aircraft during turn-on to parallel final approach.

NOTE-

1. *During triple parallel approaches, no two aircraft will be assigned the same altitude during turn-on. All three aircraft will be assigned altitudes which differ by a minimum of 1,000 feet. Example: 3,000, 4,000, 5,000; 7,000, 8,000, 9,000.*

2. *Communications transfer to the tower controller's frequency shall be completed prior to losing vertical separation between aircraft.*

2. Dual parallel runway centerlines are at least 4,300 feet apart.

3. Triple parallel runway centerlines are at least 5,000 feet apart and the airport field elevation is less than 1,000 feet MSL.

4. A high-resolution color monitor with alert algorithms, such as the final monitor aid or that required in the precision runway monitor program shall be used to monitor approaches where:

(a) Triple parallel runway centerlines are at least 4,300 but less than 5,000 feet apart and the airport field elevation is less than 1,000 feet MSL.

(b) Triple parallel approaches to airports where the airport field elevation is 1,000 feet MSL or more require the high resolution color monitor with alert algorithms and an approved FAA aeronautical study.

5. Provide the minimum applicable radar separation between aircraft on the same final approach course.

REFERENCE-

FAAO 7110.65, *Minima, Para 5-5-4*

b. The following conditions are required when applying the minimum separation on adjacent dual or triple ILS/MLS courses allowed in subpara a:

1. Straight-in landings will be made.

2. ILS, MLS, radar, and appropriate frequencies are operating normally.

3. Inform aircraft that simultaneous ILS/MLS approaches are in use prior to aircraft departing an outer fix. This information may be provided through the ATIS.

4. Clear the aircraft to descend to the appropriate glideslope/glidepath intercept altitude soon enough to provide a period of level flight to dissipate excess speed. Provide at least 1 mile of straight flight prior to the final approach course intercept.

NOTE-

Not applicable to curved and segmented MLS approaches.

5. An NTZ at least 2,000 feet wide is established an equal distance between extended runway final approach courses and shall be depicted on the monitor display. The primary responsibility for navigation on the final approach course rests with the pilot. Control instructions and information are issued only to ensure separation between aircraft and to prevent aircraft from penetrating the NTZ.

6. Monitor all approaches regardless of weather. Monitor local control frequency to receive any aircraft transmission. Issue control instructions as necessary to ensure aircraft do not enter the NTZ.

NOTE-

1. *Separate monitor controllers, each with transmit/receive and override capability on the local control frequency, shall ensure aircraft do not penetrate the depicted NTZ. Facility directives shall define responsibility for providing the minimum applicable longitudinal separation between aircraft on the same final approach course.*

2. *The aircraft is considered the center of the primary radar return for that aircraft, or, if an FMA or other color final monitor aid is used, the center of the digitized target of that aircraft, for the purposes of ensuring an aircraft does not penetrate the NTZ. The provisions of para 5-5-2 Target Separation, apply also.*

c. The following procedures shall be used by the final monitor controllers:

1. Instruct the aircraft to return to the correct final approach course when aircraft are observed to overshoot the turn-on or to continue on a track which will penetrate the NTZ.

PHRASEOLOGY–

YOU HAVE CROSSED THE FINAL APPROACH COURSE. TURN (left/right) IMMEDIATELY AND RETURN TO LOCALIZER/AZIMUTH COURSE,

or

TURN (left/right) AND RETURN TO THE LOCALIZER/AZIMUTH COURSE.

2. Instruct aircraft on the adjacent final approach course to alter course to avoid the deviating aircraft when an aircraft is observed penetrating or in the controller's judgement will penetrate the NTZ.

PHRASEOLOGY–

TRAFFIC ALERT, (call sign), TURN (right/left) IMMEDIATELY HEADING (degrees), CLIMB AND MAINTAIN (altitude).

3. Terminate radar monitoring when one of the following occurs:

(a) Visual separation is applied.

(b) The aircraft reports the approach lights or runway in sight.

(c) The aircraft is 1 mile or less from the runway threshold, if procedurally required and contained in facility directives.

4. Do not inform the aircraft when radar monitoring is terminated.

5. Do not apply the provisions of para 5–13–1, Monitor on PAR Equipment, for simultaneous ILS, MLS, or ILS and MLS approaches.

d. Consideration should be given to known factors that may in any way affect the safety of the instrument approach phase of flight when simultaneous ILS, MLS, or ILS and MLS approaches are being conducted to parallel runways. Factors include but are not limited to wind direction/velocity, wind-shear alerts/reports, severe weather activity, etc. Closely monitor weather activity that could impact the final approach course. Weather conditions in the vicinity of the final approach course may dictate a change of approach in use.

REFERENCE–

FAAO 7110.65, Radar Service Termination, Para 5–1–13
FAAO 7110.65, Final Approach Course Interception, Para 5–9–2

5–9–8. SIMULTANEOUS INDEPENDENT DUAL ILS/MLS APPROACHES– HIGH UPDATE RADAR TERMINAL

a. Authorize simultaneous independent ILS, MLS, or ILS and MLS approaches to parallel dual runways with centerlines separated by at least 3,000 feet with one localizer offset by 2.5 degrees using a precision runway monitor system with a 1.0 second radar update system and when centerlines are separated by 3,400 to 4,300 feet when precision runway monitors are utilized with a radar update rate of 2.4 seconds or less; and

1. Provide a minimum of 1,000 feet vertical or a minimum of 3 miles radar separation between aircraft during turn-on to parallel final approach.

NOTE–

Communications transfer to the tower controller's frequency shall be completed prior to losing vertical separation between aircraft.

2. Provide the minimum applicable radar separation between aircraft on the same final approach course.

REFERENCE–

FAAO 7110.65, Minima, Para 5–5–4

b. The following conditions are required when applying the minimum separation on dual ILS/MLS courses allowed in subpara a:

1. Straight-in landings will be made.

2. ILS, MLS, radar, and appropriate frequencies are operating normally.

3. Inform aircraft that closely spaced simultaneous ILS/MLS approaches are in use prior to aircraft departing an outer fix. This information may be provided through the ATIS.

4. Clear the aircraft to descend to the appropriate glideslope/glidepath intercept altitude soon enough to provide a period of level flight to dissipate excess speed. Provide at least 1 mile of straight flight prior to the final approach course intercept.

NOTE–

Not applicable to curved and segmented MLS approaches.

5. An NTZ at least 2,000 feet wide is established an equal distance between extended runway final approach courses and shall be depicted on the monitor display. The primary responsibility for navigation on the final approach course rests with the

pilot. Control instructions and information are issued only to ensure separation between aircraft and to prevent aircraft from penetrating the NTZ.

6. Monitor all approaches regardless of weather. Monitor local control frequency to receive any aircraft transmission. Issue control instructions as necessary to ensure aircraft do not enter the NTZ.

7. Separate monitor controllers, each with transmit/receive and override capability on the local control frequency, shall ensure aircraft do not penetrate the depicted NTZ. Facility directives shall define the responsibility for providing the minimum applicable longitudinal separation between aircraft on the same final approach course.

NOTE-

The aircraft is considered the center of the digitized target for that aircraft for the purposes of ensuring an aircraft does not penetrate the NTZ.

c. The following procedures shall be used by the final monitor controllers:

1. A controller shall provide position information to an aircraft that is (left/right) of the depicted localizer centerline, and in their opinion is continuing on a track that may penetrate the NTZ.

PHRASEOLOGY-

(Aircraft call sign) I SHOW YOU (left/right) OF THE FINAL APPROACH COURSE.

2. Instruct the aircraft to return immediately to the correct final approach course when aircraft are observed to overshoot the turn-on or continue on a track which will penetrate the NTZ.

PHRASEOLOGY-

YOU HAVE CROSSED THE FINAL APPROACH COURSE. TURN (left/right) IMMEDIATELY AND RETURN TO LOCALIZER/AZIMUTH COURSE.

or

TURN (left/right) AND RETURN TO THE LOCALIZER/AZIMUTH COURSE.

3. Instruct aircraft on the adjacent final approach course to alter course to avoid the deviating aircraft when an aircraft is observed penetrating or in the controller's judgement will penetrate the NTZ.

NOTE-

An instruction that may include a descent to avoid the deviating aircraft should only be used when there is no other reasonable option available to the controller. In such a case, the descent shall not put the aircraft below the MVA.

PHRASEOLOGY-

TRAFFIC ALERT, (call sign), TURN (left/right) IMMEDIATELY HEADING (DEGREES), CLIMB AND MAINTAIN (altitude).

4. Terminate radar monitoring when one of the following occurs:

(a) Visual separation is applied.

(b) The aircraft reports the approach lights or runway in sight.

(c) The aircraft has landed or, in the event of a missed approach, is one-half mile beyond the departure end of the runway.

5. Do not inform the aircraft when radar monitoring is terminated.

6. Do not apply the provisions of para 5-13-1, Monitor on PAR Equipment, for simultaneous ILS, MLS, or ILS and MLS approaches.

d. Consideration should be given to known factors that may in any way affect the safety of the instrument approach phase of flight when simultaneous ILS, MLS, or ILS and MLS approaches are being conducted to parallel runways. Factors include but are not limited to wind direction/velocity, wind-shear alerts/reports, severe weather activity, etc. Closely monitor weather activity that could impact the final approach course. Weather conditions in the vicinity of the final approach course may dictate a change of the approach in use.

REFERENCE-

*FAAO 7110.65, Radar Service Termination, Para 5-1-13
FAAO 7110.65, Final Approach Course Interception, Para 5-9-2*

Section 10. Radar Approaches– Terminal

5–10–1. APPLICATION

a. Provide radar approaches in accordance with standard or special instrument approach procedures.

b. A radar approach may be given to any aircraft upon request and may be offered to aircraft in distress regardless of weather conditions or to expedite traffic.

NOTE–

Acceptance of a radar approach by a pilot does not waive the prescribed weather minima for the airport or for the particular aircraft operator concerned. The pilot is responsible for determining if the approach and landing are authorized under the existing weather minima.

REFERENCE–

FAAO 7110.65, Final Approach Course Interception, Para 5–9–2
FAAO 7110.65, Elevation Failure, Para 5–12–10

5–10–2. APPROACH INFORMATION

a. Issue the following information to an aircraft that will conduct a radar approach. Current approach information contained in the ATIS broadcast may be omitted if the pilot states the appropriate ATIS broadcast code. All items listed below, except for subpara 3 may be omitted after the first approach if repeated approaches are made and no change has occurred. Transmissions with aircraft in this phase of the approach should occur approximately every minute.

REFERENCE–

FAAO 7110.65, Approach Information, Para 4–7–10

1. Altimeter setting.

2. If available, ceiling and visibility if the ceiling at the airport of intended landing is reported below 1,000 feet or below the highest circling minimum, whichever is greater, or if the visibility is less than 3 miles. Advise pilots when weather information is available via the Automated Weather Observing System (AWOS)/Automated Surface Observing System (ASOS) and, if requested, issue the appropriate frequency.

NOTE–

Automated weather observing systems may be set to provide one minute updates. This one minute data may be useful to the pilot for possible weather trends. Controllers provide service based solely on official weather, i.e., hourly and special observations.

3. Issue any known changes classified as special weather observations as soon as possible. Special weather observations need not be issued after they are included in the ATIS broadcast and the pilot states the appropriate ATIS broadcast code.

4. Pertinent information on known airport conditions if they are considered necessary to the safe operation of the aircraft concerned.

5. Lost communication procedures as specified in para 5–10–4, Lost Communications.

b. Before starting final approach:

NOTE–

1. *ASR approach procedures may be prescribed for specific runways, for an airport/heliport, and for helicopters only to a “point-in-space,” i.e., a MAP from which a helicopter must be able to proceed to the landing area by visual reference to a prescribed surface route.*

2. *Occasionally, helicopter PAR approaches are available to runways where conventional PAR approaches have been established. In those instances where the two PAR approaches serve the same runway, the helicopter approach will have a steeper glide slope and a lower decision height. By the controllers designating the approach to be flown, the helicopter pilot understands which of the two approaches he/she has been vectored for and which set of minima apply.*

1. Inform the aircraft of the type of approach, runway, airport, heliport, or other point, as appropriate, to which the approach will be made. Specify the airport name when the approach is to a secondary airport.

PHRASEOLOGY–

THIS WILL BE A P–A–R/SURVEILLANCE APPROACH TO:

RUNWAY (runway number),

or

(airport name) AIRPORT, RUNWAY (runway number),

or

(airport name) AIRPORT/HELIPORT.

THIS WILL BE A COPTER P–A–R APPROACH TO:

RUNWAY (runway number),

or

(airport name) AIRPORT, RUNWAY (runway number),

or

(airport name) AIRPORT/HELIPORT.

2. For surveillance approaches, specify the location of the MAP in relation to the runway/airport/heliport.

PHRASEOLOGY-

MISSED APPROACH POINT IS (distance) MILE(S) FROM RUNWAY/AIRPORT/HELIPORT,

or for a point-in-space approach,

A MISSED APPROACH POINT (distance) MILE(S) (direction from landing area) OF (airport name) AIRPORT/HELIPORT.

EXAMPLE-

Helicopter point-in-space approach:

“Army copter Zulu Two, this will be a surveillance approach to a missed approach point, three point five miles south of Creedon Heliport.”

REFERENCE-

FAAO 7110.65, Elevation Failure, Para 5-12-10

c. Inform an aircraft making an approach to an airport not served by a tower that no traffic or landing runway information is available for that airport.

PHRASEOLOGY-

NO TRAFFIC OR LANDING RUNWAY INFORMATION AVAILABLE FOR THE AIRPORT.

REFERENCE-

FAAO 7110.65, Altimeter Setting Issuance Below Lowest Usable FL, Para 2-7-2

FAAO 7110.65, Final Approach Course Interception, Para 5-9-2

5-10-3. NO-GYRO APPROACH

When an aircraft will make a no-gyro surveillance or a PAR approach:

a. Before issuing a vector, inform the aircraft of the type of approach.

PHRASEOLOGY-

THIS WILL BE A NO-GYRO SURVEILLANCE/P-A-R APPROACH.

b. Instruct the aircraft when to start and stop turn.

PHRASEOLOGY-
TURN LEFT/RIGHT.
STOP TURN.

c. After turn on to final approach has been made and prior to the aircraft reaching the approach gate, instruct the aircraft to make half-standard rate turns.

PHRASEOLOGY-

MAKE HALF-STANDARD RATE TURNS.

REFERENCE-

FAAO 7110.65, Final Approach Course Interception, Para 5-9-2

FAAO 7110.65, Elevation Failure, Para 5-12-10

5-10-4. LOST COMMUNICATIONS

When weather reports indicate that an aircraft will likely encounter IFR weather conditions during the approach, take the following action as soon as possible after establishing radar identification and radio communications (may be omitted after the first approach when successive approaches are made and the instructions remain the same):

NOTE-

Air traffic control facilities at U.S. Army and U.S. Air Force installations are not required to transmit lost communications instructions to military aircraft. All military facilities will issue specific lost communications instructions to civil aircraft when required.

a. If lost communications instructions will require the aircraft to fly on an unpublished route, issue an appropriate altitude to the pilot. If the lost communications instructions are the same for both pattern and final, the pattern/vector controller shall issue both. Advise the pilot that if radio communications are lost for a specified time interval (not more than 1 minute) on vector to final approach, 15 seconds on a surveillance final approach, or 5 seconds on a PAR final approach to:

1. Attempt contact on a secondary or a tower frequency.

2. Proceed in accordance with visual flight rules if possible.

3. Proceed with an approved nonradar approach, or execute the specific lost communications procedure for the radar approach being used.

NOTE-

The approved procedures are those published on the FAA Forms 8260 or applicable military document.

PHRASEOLOGY–

IF NO TRANSMISSIONS ARE RECEIVED FOR (time interval) IN THE PATTERN OR FIVE/FIFTEEN SECONDS ON FINAL APPROACH, ATTEMPT CONTACT ON (frequency), AND

if the possibility exists,

PROCEED VFR. IF UNABLE:

if approved,

PROCEED WITH (nonradar approach), MAINTAIN (altitude) UNTIL ESTABLISHED ON/OVER FIX/NAVAID/APPROACH PROCEDURE,

or

(alternative instructions).

PHRASEOLOGY–

USN. *For ACLS operations using Mode I, IA, and II,*

IF NO TRANSMISSIONS ARE RECEIVED FOR FIVE SECONDS AFTER LOSS OF DATA LINK, ATTEMPT CONTACT ON (frequency), AND

if the possibility exists,

PROCEED VFR. IF UNABLE:

if approved,

PROCEED WITH (nonradar approach), MAINTAIN (altitude) UNTIL ESTABLISHED ON/OVER FIX/NAVAID/APPROACH PROCEDURE,

or

(alternative instructions).

b. If the final approach lost communications instructions are changed, differ from those for the pattern, or are not issued by the pattern controller, they shall be issued by the final controller.

c. If the pilot states that he/she cannot accept a lost communications procedure due to weather conditions or other reasons, request the pilot's intention.

NOTE–

The pilot is responsible for determining the adequacy of lost communications procedures with respect to aircraft performance, equipment capability, or reported weather.

REFERENCE–

FAAO 7110.65, Final Approach Course Interception, Para 5–9–2

FAAO 7110.65, Approach Information, Para 5–10–2

FAAO 7110.65, Elevation Failure, Para 5–12–10

5–10–5. RADAR CONTACT LOST

If radar contact is lost during an approach and the aircraft has not started final approach, clear the aircraft to an appropriate NAVAID/fix for an instrument approach.

REFERENCE–

FAAO 7110.65, Final Approach Course Interception, Para 5–9–2

FAAO 7110.65, Final Approach Abnormalities, Para 5–10–14

FAAO 7110.65, Elevation Failure, Para 5–12–10

5–10–6. LANDING CHECK

USA/USN. Advise the pilot to perform landing check while the aircraft is on downwind leg and in time to complete it before turning base leg. If an incomplete pattern is used, issue this before handoff to the final controller for a PAR approach, or before starting descent on final approach for surveillance approach.

PHRASEOLOGY–

PERFORM LANDING CHECK.

REFERENCE–

FAAO 7110.65, Final Approach Course Interception, Para 5–9–2

FAAO 7110.65, Elevation Failure, Para 5–12–10

5–10–7. POSITION INFORMATION

Inform the aircraft of its position at least once before starting final approach.

PHRASEOLOGY–

(Number) MILES (direction) OF (airport name) AIRPORT,

or

(number) MILES (direction) OF (airport name) AIRPORT ON DOWNWIND/BASE LEG.

REFERENCE–

FAAO 7110.65, Final Approach Course Interception, Para 5–9–2

FAAO 7110.65, Elevation Failure, Para 5–12–10

5–10–8. FINAL CONTROLLER CHANGEOVER

When instructing the aircraft to change frequency for final approach guidance, include the name of the facility.

PHRASEOLOGY–

CONTACT (name of facility) FINAL CONTROLLER ON (frequency).

REFERENCE-

FAAO 7110.65, *Radio Communications Transfer, Para 2-1-17*
 FAAO 7110.65, *Final Approach Course Interception, Para 5-9-2*
 FAAO 7110.65, *Arrival Instructions, Para 5-9-4*
 FAAO 7110.65, *Elevation Failure, Para 5-12-10*

5-10-9. COMMUNICATIONS CHECK

On initial contact with the final controller, ask the aircraft for a communication check.

PHRASEOLOGY-

(Aircraft call sign), (name of facility) FINAL CONTROLLER. HOW DO YOU HEAR ME?

REFERENCE-

FAAO 7110.65, *Final Approach Course Interception, Para 5-9-2*
 FAAO 7110.65, *Elevation Failure, Para 5-12-10*

5-10-10. TRANSMISSION ACKNOWLEDGMENT

After contact has been established with the final controller and while on the final approach course, instruct the aircraft not to acknowledge further transmissions.

PHRASEOLOGY-

DO NOT ACKNOWLEDGE FURTHER TRANSMISSIONS.

REFERENCE-

FAAO 7110.65, *Final Approach Course Interception, Para 5-9-2*
 FAAO 7110.65, *Elevation Failure, Para 5-12-10*

5-10-11. MISSED APPROACH

Before an aircraft starts final descent for a full stop landing and weather reports indicate that any portion of the final approach will be conducted in IFR conditions, issue a specific missed approach procedure approved for the radar approach being conducted.

PHRASEOLOGY-

YOUR MISSED APPROACH PROCEDURE IS (missed approach procedure).

NOTE-

1. *The specific missed approach procedure is published on FAA Form 8260-4 or applicable military document.*

2. USAF. *At locations where missed approach instructions are published in base flying regulations, controllers need not issue missed approach instructions to locally assigned/attached aircraft.*

REFERENCE-

FAAO 7110.65, *Final Approach Course Interception, Para 5-9-2*
 FAAO 7110.65, *Elevation Failure, Para 5-12-10*

5-10-12. LOW APPROACH AND TOUCH-AND-GO

Before an aircraft which plans to execute a low approach or touch-and-go begins final descent, issue appropriate departure instructions to be followed upon completion of the approach. Climb-out instructions must include a specific heading and altitude except when the aircraft will maintain VFR and contact the tower.

PHRASEOLOGY-

AFTER COMPLETING LOW APPROACH/TOUCH AND GO:

CLIMB AND MAINTAIN (altitude).

TURN (right or left) HEADING (degrees)/FLY RUNWAY HEADING,

or

MAINTAIN VFR, CONTACT TOWER,

or

(other instructions as appropriate).

NOTE-

This may be omitted after the first approach if instructions remain the same.

REFERENCE-

FAAO 7110.65, *Final Approach Course Interception, Para 5-9-2*
 FAAO 7110.65, *Elevation Failure, Para 5-12-10*

5-10-13. TOWER CLEARANCE

a. When an aircraft is on final approach to an airport served by a tower, obtain a clearance to land, touch-and-go, or make low approach. Issue the clearance and the surface wind to the aircraft.

b. If the clearance is not obtained or is canceled, inform the aircraft and issue alternative instructions.

PHRASEOLOGY-

TOWER CLEARANCE CANCELED/NOT RECEIVED (alternative instructions).

REFERENCE-

FAAO 7110.65, *Final Approach Course Interception, Para 5-9-2*
 FAAO 7110.65, *Elevation Failure, Para 5-12-10*

5-10-14. FINAL APPROACH ABNORMALITIES

Instruct the aircraft if runway environment not in sight, execute a missed approach if previously given; or climb to or maintain a specified altitude and fly a specified course whenever the completion of a safe approach is questionable because one or more of the following conditions exists. The conditions in subparas a, b, and c do not apply after the aircraft passes decision height on a PAR approach.

EXAMPLE-

Typical reasons for issuing missed approach instructions:

“Radar contact lost.”

“Too high/low for safe approach.”

“Too far right/left for safe approach.”

REFERENCE-

FAAO 7110.65, Position Advisories, Para 5-12-7

a. Safety limits are exceeded or radical target deviations are observed.

b. Position or identification of the aircraft is in doubt.

c. Radar contact is lost or a malfunctioning radar is suspected.

PHRASEOLOGY-

(Reason) IF RUNWAY/APPROACH LIGHTS/RUNWAY LIGHTS NOT IN SIGHT, EXECUTE MISSED APPROACH/(alternative instructions).

NOTE-

If the pilot requests, approval may be granted to proceed with the approach via ILS or another navigational aid/approach aid.

REFERENCE-

FAAO 7110.65, Radar Contact Lost, Para 5-10-5

d. Airport conditions or traffic preclude approach completion.

PHRASEOLOGY-

EXECUTE MISSED APPROACH/(alternative instructions), (reason).

REFERENCE-

FAAO 7110.65, Final Approach Course Interception, Para 5-9-2

FAAO 7110.65, Elevation Failure, Para 5-12-10

5-10-15. MILITARY SINGLE FREQUENCY APPROACHES

a. Utilize single frequency approach procedures as contained in a letter of agreement.

b. Do not require a frequency change from aircraft on a single frequency approach after the approach has begun unless:

1. Landing or low approach has been completed.

2. The aircraft is in visual flight rules (VFR) conditions during daylight hours.

3. The pilot requests the frequency change.

4. An emergency situation exists.

5. The aircraft is cleared for a visual approach.

6. The pilot cancels instrument flight rules (IFR).

c. Accomplish the following steps to complete communications transfer on single frequency approaches after completion of a handoff:

1. Transferring controller: Position transmitter selectors to preclude further transmissions on the special use frequencies.

2. Receiving controller: Position transmitter and receiver selectors to enable communications on the special use frequencies.

3. Do not require or expect the flight to check on frequency unless an actual frequency change is transmitted to the pilot.

Section 11. Surveillance Approaches– Terminal

5–11–1. ALTITUDE INFORMATION

Provide recommended altitudes on final approach if the pilot requests. If recommended altitudes are requested, inform the pilot that recommended altitudes which are at or above the published MDA will be given for each mile on final.

REFERENCE–

FAAO 7210.3, *Recommended Altitudes for Surveillance Approaches*, Para 10–5–7.

FAAO 7110.65, *Final Approach Guidance*, Para 5–II–5.

PHRASEOLOGY–

RECOMMENDED ALTITUDES WILL BE PROVIDED FOR EACH MILE ON FINAL TO MINIMUM DESCENT ALTITUDE/CIRCLING MINIMUM DESCENT ALTITUDE.

5–11–2. VISUAL REFERENCE REPORT

Aircraft may be requested to report the runway, approach/runway lights, or airport in sight. Helicopters making a “point-in-space” approach may be requested to report when able to proceed to the landing area by visual reference to a prescribed surface route.

PHRASEOLOGY–

REPORT (runway, approach/runway lights or airport) IN SIGHT.

REPORT WHEN ABLE TO PROCEED VISUALLY TO AIRPORT/HELIPORT.

5–11–3. DESCENT NOTIFICATION

a. Issue advance notice of where descent will begin and issue the straight-in MDA prior to issuing final descent for the approaches.

NOTE–

The point at which descent to the minimum descent altitude is authorized is the final approach fix unless an altitude limiting stepdown-fix is prescribed.

b. When it is determined that the surveillance approach will terminate in a circle to land maneuver, request the aircraft approach category from the pilot. After receiving the aircraft approach category,

provide him/her with the applicable circling MDA prior to issuing final descent for the approach.

NOTE–

Pilots are normally expected to furnish the aircraft approach category to the controller when it is determined that the surveillance approach will terminate in a circle to land maneuver. If this information is not voluntarily given, solicit the aircraft approach category from the pilot, and then issue him/her the applicable circling MDA.

PHRASEOLOGY–

PREPARE TO DESCEND IN (number) MILE(S).

for straight-in approaches,

MINIMUM DESCENT ALTITUDE (altitude).

for circling approaches,

REQUEST YOUR AIRCRAFT APPROACH CATEGORY. (Upon receipt of aircraft approach category), PUBLISHED CIRCLING MINIMUM DESCENT ALTITUDE (altitude).

5–11–4. DESCENT INSTRUCTIONS

When an aircraft reaches the descent point, issue one of the following as appropriate:

REFERENCE–

FAAO 7110.65, *Elevation Failure*, Para 5–12–10

a. Unless a descent restriction exists, advise the aircraft to descend to the MDA.

PHRASEOLOGY–

(Number) MILES FROM RUNWAY/AIRPORT/ HELIPORT. DESCEND TO YOUR MINIMUM DESCENT ALTITUDE.

b. When a descent restriction exists, specify the prescribed restriction altitude. When the aircraft has passed the altitude limiting point, advise to continue descent to MDA.

PHRASEOLOGY–

(Number) MILES FROM RUNWAY/AIRPORT/ HELIPORT. DESCEND AND MAINTAIN (restriction altitude).

DESCEND TO YOUR MINIMUM DESCENT ALTITUDE.

5-11-5. FINAL APPROACH GUIDANCE

a. Issue course guidance, inform the aircraft when it is on course, and frequently inform the aircraft of any deviation from course. Transmissions with aircraft on surveillance final approach should occur approximately every 15 seconds.

PHRASEOLOGY-
HEADING (heading),

ON COURSE,

or

SLIGHTLY/WELL LEFT/RIGHT OF COURSE.

NOTE-

Controllers should not key the radio transmitter continuously during radar approaches to preclude a lengthy communications block. The decision on how often transmitters are unkeyed is the controller's prerogative.

b. Issue trend information, as required, to indicate target position with respect to the extended runway centerline and to describe the target movement as appropriate corrections are issued. Trend information may be modified by the terms "RAPIDLY" and "SLOWLY" as appropriate.

EXAMPLE-

"Going left/right of course."

"Left/right of course and holding/correcting."

c. Inform the aircraft of its distance from the runway, airport/heliport, or MAP, as appropriate, each mile on final.

PHRASEOLOGY-
(Number) MILE(S) FROM RUNWAY/AIRPORT/HELIPORT OR MISSED APPROACH POINT.

d. Recommended altitudes shall be furnished, if requested, in accordance with para 5-11-1, Altitude Information.

PHRASEOLOGY-
If requested,

ALTITUDE SHOULD BE (altitude).

5-11-6. APPROACH GUIDANCE TERMINATION

a. Discontinue surveillance approach guidance when:

1. Requested by the pilot.

2. In your opinion, continuation of a safe approach to the MAP is questionable.

3. The aircraft is over the MAP.

b. Surveillance approach guidance may be discontinued when the pilot reports the runway or approach/runway lights in sight or if a "point-in-space" approach, he/she reports able to proceed to the landing area by visual reference to a prescribed surface route.

c. When approach guidance is discontinued in accordance with subpara a and the aircraft has reported the runway or approach/runway lights in sight, advise the aircraft of its position and to proceed visually.

PHRASEOLOGY-
(Distance) MILE(S) FROM RUNWAY/AIRPORT/HELIPORT,

or

OVER MISSED APPROACH POINT.

PROCEED VISUALLY (additional instructions/clearance as required.)

d. When approach guidance is discontinued in accordance with subpara a above and the aircraft has not reported the runway or approach/runway lights in sight, advise the aircraft of its position and to execute a missed approach unless the runway or approach/runway lights are in sight or, if a "point-in-space" approach, unless able to proceed visually.

PHRASEOLOGY-
(Distance) MILE(S) FROM RUNWAY,

or

*OVER MISSED APPROACH POINT.
IF RUNWAY,*

or

*APPROACH/RUNWAY LIGHTS NOT IN SIGHT,
EXECUTE MISSED APPROACH/(missed approach instructions). (Additional instructions/clearance, as required.)*

*(Distance and direction) FROM AIRPORT/HELIPORT/
MISSED APPROACH POINT.*

*IF UNABLE TO PROCEED VISUALLY, EXECUTE
MISSED APPROACH. (Additional instructions/clearance, if required.)*

NOTE-

Terminal instrument approach procedures and flight inspection criteria require establishment of a MAP for each procedure including the point to which satisfactory radar guidance can be provided.

Section 12. PAR Approaches– Terminal

5–12–1. GLIDEPATH NOTIFICATION

Inform the aircraft when it is approaching glidepath (approximately 10 to 30 seconds before final descent).

PHRASEOLOGY–
APPROACHING GLIDEPATH.

5–12–2. DECISION HEIGHT (DH) NOTIFICATION

Provide the DH to any pilot who requests it.

PHRASEOLOGY–
DECISION HEIGHT (number of feet).

5–12–3. DESCENT INSTRUCTION

When an aircraft reaches the point where final descent is to start, instruct it to begin descent.

PHRASEOLOGY–
BEGIN DESCENT.

5–12–4. GLIDEPATH AND COURSE INFORMATION

a. Issue course guidance and inform the aircraft when it is on glidepath and on course, and frequently inform the aircraft of any deviation from glidepath or course. Transmissions with aircraft on precision final approach should occur approximately every 5 seconds.

PHRASEOLOGY–
HEADING (heading).

ON GLIDEPATH.

ON COURSE,

or

SLIGHTLY/WELL ABOVE/BELOW GLIDEPATH.

SLIGHTLY/WELL LEFT/RIGHT OF COURSE.

NOTE–

Controllers should not key the radio transmitter continuously during radar approaches to preclude a lengthy communications block. The decision on how often transmitters are unkeyed is the controller’s prerogative.

b. Issue trend information as required, to indicate target position with respect to the azimuth and

elevation cursors and to describe target movement as appropriate corrections are issued. Trend information may be modified by the terms “RAPIDLY” or “SLOWLY”, as appropriate.

EXAMPLE–

“Going above/below glidepath.”

“Going right/left of course.”

“Above/below glidepath and coming down/up.”

“Above/below glidepath and holding.”

“Left/right of course and holding/correcting.”

REFERENCE–

FAAO 7110.65, Position Advisories, Para 5–12–7

FAAO 7110.65, Monitor Information, Para 5–13–3

5–12–5. DISTANCE FROM TOUCHDOWN

Inform the aircraft of its distance from touchdown at least once each mile on final approach.

PHRASEOLOGY–
(Number of miles) MILES FROM TOUCHDOWN.

5–12–6. DECISION HEIGHT

Inform the aircraft when it reaches the published decision height.

PHRASEOLOGY–
AT DECISION HEIGHT.

5–12–7. POSITION ADVISORIES

a. Continue to provide glidepath and course information prescribed in para 5–12–4, Glidepath and Course Information, subparas a and b, until the aircraft passes over threshold.

NOTE–

Glidepath and course information provided below decision height is advisory only. 14 CFR Section 91.175 outlines pilot responsibilities for descent below decision height.

b. Inform the aircraft when it is passing over the approach lights.

PHRASEOLOGY–
OVER APPROACH LIGHTS.

c. Inform the aircraft when it is passing over the landing threshold and inform it of its position with respect to the final approach course.

PHRASEOLOGY–
OVER LANDING THRESHOLD, (position with respect to course).

REFERENCE-

FAAO 7110.65, *Final Approach Abnormalities, Para 5-10-14*

5-12-8. APPROACH GUIDANCE TERMINATION

a. Discontinue precision approach guidance when:

1. Requested by the pilot.
2. In your opinion, continuation of a safe approach to the landing threshold is questionable.
3. The aircraft passes over landing threshold.
4. The pilot reports the runway/approach lights in sight and requests to or advises that he/she will proceed visually.

NOTE-

A pilot's report of "runway in sight" or "visual" is not a request to proceed visually.

b. When precision approach guidance is discontinued in accordance with subpara a, advise the aircraft of its position and to proceed visually.

PHRASEOLOGY-

(Distance) MILE(S) FROM TOUCHDOWN, PROCEED VISUALLY (additional instructions/clearance as required).

c. After a pilot has reported the runway/approach lights in sight and requested to or advised that he/she will proceed visually, and has been instructed to proceed visually, all PAR approach procedures shall be discontinued.

d. Continue to monitor final approach and frequency. Pilots shall remain on final controller's frequency until touchdown or otherwise instructed.

REFERENCE-

FAAO 7110.65, *Final Approach Abnormalities, Para 5-10-14.*

5-12-9. COMMUNICATION TRANSFER

Issue communications transfer instructions.

PHRASEOLOGY-

CONTACT (terminal control function) (frequency, if required) AFTER LANDING.

NOTE-

Communications transfer instructions should be delayed slightly until the aircraft is on the landing roll-out to

preclude diversion of the pilot's attention during transition and touchdown.

REFERENCE-

FAAO 7110.65, *Radio Communications Transfer, Para 2-1-17*

5-12-10. ELEVATION FAILURE

a. If the elevation portion of PAR equipment fails during a precision approach:

1. Discontinue PAR instructions and tell the aircraft to take over visually or if unable, to execute a missed approach. If the aircraft executes a missed approach, apply subpara 2 below.

PHRASEOLOGY-

NO GLIDEPATH INFORMATION AVAILABLE. IF RUNWAY, APPROACH/RUNWAY LIGHTS, NOT IN SIGHT, EXECUTE MISSED APPROACH/(alternative instructions).

2. If a surveillance approach, ASR or PAR without glide slope, is established for the same runway, inform the aircraft that a surveillance approach can be given. Use ASR or the azimuth portion of the PAR to conduct the approach and apply Chapter 5, Radar, Section 11, Surveillance Approaches- Terminal. When the PAR azimuth is used, inform the pilot that mileage information will be from touchdown, and at those runways where specific minima have been established for PAR without glideslope, inform the pilot that the PAR azimuth will be used for the approach.

EXAMPLE-

1. *Approach information when PAR azimuth used:*

"This will be a surveillance approach to runway three six. Mileages will be from touchdown."

or

"This will be a surveillance approach to runway three six using P-A-R azimuth. Mileages will be from touchdown."

2. *Descent Instructions:*

"Five miles from touchdown, descend to your minimum descent altitude/minimum altitude."

REFERENCE-

FAAO 7110.65, *Approach Information, Para 5-10-2*

FAAO 7110.65, *Descent Instructions, Para 5-II-4*

b. If the elevation portion of the PAR equipment is inoperative before starting a precision approach, apply subpara a2.

5-12-11. SURVEILLANCE UNUSABLE

PAR approaches may be conducted when the ASR is unusable provided a nonradar instrument approach will position the aircraft over a navigational aid or DME fix within the precision radar coverage, or an adjacent radar facility can provide a direct radar handoff to the PAR controller.

NOTE-

The display of the NAVAID or DME fix in accordance with para 5-3-2 Primary Radar Identification Methods, is not required provided the NAVAID or DME fix can be correlated on a PAR scope.

Section 13. Use of PAR for Approach Monitoring– Terminal

5–13–1. MONITOR ON PAR EQUIPMENT

USAF not applicable. Aircraft conducting precision or nonprecision approaches shall be monitored by PAR equipment if the PAR final approach course coincides with the NAVAID final approach course from the final approach fix to the runway and one of the following conditions exists:

NOTE–

1. The provisions of this section do not apply to monitoring simultaneous ILS, MLS, or ILS and MLS approaches.

2. This procedure is used in PAR facilities operated by the FAA and other military services at joint-use civil/military locations and military installations during the operational hours of the PAR.

a. The reported weather is below basic VFR minima.

b. **USA Not applicable.** At night.

c. Upon request of the pilot.

REFERENCE–

FAAO 7110.65, *Simultaneous Independent ILS/MLS Approaches– Dual & Triple, Para 5–9–7*

5–13–2. MONITOR AVAILABILITY

a. Inform the aircraft of the frequency on which monitoring information will be transmitted if it will not be the same as the communication frequency used for the approach.

PHRASEOLOGY–

RADAR MONITORING ON LOCALIZER VOICE (frequency),

and if applicable,

CONTACT (terminal control function) (frequency, if required) AFTER LANDING.

b. If the approach is not monitored, inform the aircraft that radar monitoring is not available.

PHRASEOLOGY–

RADAR MONITORING NOT AVAILABLE.

c. If conditions prevent continued monitor after the aircraft is on final approach, advise the pilot. State

the reason and issue alternate procedures as appropriate.

PHRASEOLOGY–

(Reason), RADAR MONITORING NOT AVAILABLE, (alternative instructions).

NOTE–

Approach monitoring is a vital service, but during the approach, the controller acts primarily as a safety observer and does not actually guide the aircraft. Loss of the radar monitoring capability (and thus availability) is no reason to terminate an otherwise good instrument approach. Advise the pilot that radar contact has been lost (or other reason as appropriate), that radar monitoring is not available, and of actions for the pilot to take in either proceeding with or breaking off the approach; i.e., contact tower, remain on PAR frequency, etc.

5–13–3. MONITOR INFORMATION

When approaches are monitored, take the following action:

a. Advise the pilot executing a nonprecision approach that glidepath advisories are not provided. Do this prior to the pilot beginning the final descent.

PHRASEOLOGY–

GLIDEPATH ADVISORIES WILL NOT BE PROVIDED.

b. Inform the aircraft when passing the final approach fix (nonprecision approaches) or when passing the outer marker or the fix used in lieu of the outer marker (precision approaches).

PHRASEOLOGY–

PASSING (FIX).

c. Advise the pilot of glidepath trend information (precision approaches) and course trend information to indicate target position and movement with respect to the elevation or azimuth cursor when the aircraft target corresponds to a position of well above/below the glidepath or well left/right of course and whenever the aircraft exceeds the radar safety limits. Repeat if no correction is observed.

EXAMPLE–

Course trend information:

“(Ident), well right/left of P–A–R course, drifting further right/left.”

Glidepath trend information:

“(Ident), well above/below P–A–R glidepath.”

REFERENCE-

FAAO 7110.65, Glidepath and Course Information, Para 5-12-4

d. If, after repeated advisories, the aircraft is observed proceeding outside the safety limits or a radical target deviation is observed, advise the aircraft if unable to proceed visually, to execute a missed approach. Issue a specific altitude and heading if a procedure other than the published missed approach is to be executed.

PHRASEOLOGY-

(Position with respect to course or glidepath). IF NOT VISUAL, ADVISE YOU EXECUTE MISSED APPROACH (alternative instructions).

e. Provide monitor information until the aircraft is over the landing threshold or commences a circling approach.

f. Provide azimuth monitoring only at locations where the MLS glidepath and the PAR glidepath are not coincidental.

REFERENCE-

FAAO 7110.65, Radar Service Termination, Para 5-1-13

Section 14. Automation– En Route

5–14–1. CONFLICT ALERT (CA) AND MODE C INTRUDER (MCI) ALERT

a. When a CA or MCI alert is displayed, evaluate the reason for the alert without delay and take appropriate action.

NOTE–

DARC does not have CA/MCI alert capability.

REFERENCE–

FAAO 7110.65, Safety Alert, Para 2–1–6

b. If another controller is involved in the alert, initiate coordination to ensure an effective course of action. Coordination is not required when immediate action is dictated.

c. Suppressing/Inhibiting CA/MCI alert.

1. The controller may suppress the display of a CA/MCI alert from a control position with the application of one of the following suppress/inhibit computer functions:

(a) The Conflict Suppress (CO) function may be used to suppress the CA/MCI display between specific aircraft for a specific alert.

NOTE–

See NAS–MD–678 for the EARTS conflict suppress message.

(b) The Group Suppression (SG) function shall be applied exclusively to inhibit the displaying of alerts among military aircraft engaged in special military operations where standard en route separation criteria does not apply.

NOTE–

Special military operations where the SG function would typically apply involve those activities where military aircraft routinely operate in proximities to each other that are less than standard en route separation criteria; i.e., air refueling operations, ADC practice intercept operations, etc.

2. The computer entry of a message suppressing a CA/MCI alert constitutes acknowledgment for the alert and signifies that appropriate action has or will be taken.

3. The CA/MCI alert may not be suppressed or inhibited at or for another control position without being coordinated.

5–14–2. EN ROUTE MINIMUM SAFE ALTITUDE WARNING (E-MSAW)

a. When an E-MSAW alert is displayed, immediately analyze the situation and take the appropriate action to resolve the alert.

NOTE–

Caution should be exercised when issuing a clearance to an aircraft in reaction to an E-MSAW alert to ensure that adjacent MIA areas are not a factor.

REFERENCE–

FAAO 7110.65, Safety Alert, Para 2–1–6

b. The controller may suppress the display of an E-MSAW alert from his/her control position with the application of one of the following suppress/inhibit computer functions:

1. The specific alert suppression message may be used to inhibit the E-MSAW alerting display on a single flight for a specific alert.

2. The indefinite alert suppression message shall be used exclusively to inhibit the display of E-MSAW alerts on aircraft known to be flying at an altitude that will activate the alert feature of one or more MIA areas within an ARTCC.

NOTE–

1. *The indefinite alert suppression message will remain in effect for the duration of the referenced flight's active status within the ARTCC unless modified by controller action.*

2. *The indefinite alert suppression message would typically apply to military flights with clearance to fly low-level type routes that routinely require altitudes below established minimum IFR altitudes.*

c. The computer entry of a message suppressing or inhibiting E-MSAW alerts constitutes acknowledgment for the alert and indicates that appropriate action has or will be taken to resolve the situation.

5–14–3. COMPUTER ENTRY OF ASSIGNED ALTITUDE

The data block shall always reflect the current status of the aircraft unless otherwise specified in a facility directive. Whenever an aircraft is cleared to maintain an altitude different from that in the flight plan database, enter into the computer one of the following:

NOTE-

A facility directive may be published deleting the interim altitude computer entry requirements of subpara b. The directive would apply to those conditions where heavy traffic or sector complexity preclude meeting these entry requirements.

REFERENCE-

FAAO 7210.3, Waiver to Interim Altitude Requirements, Para 8-2-7.

a. The new assigned altitude if the aircraft will (climb or descend to and) maintain the new altitude, or

b. An interim altitude if the aircraft will (climb or descend to and) maintain the new altitude for a short period of time and subsequently be recleared to the altitude in the flight plan database or a new altitude or a new interim altitude.

NOTE-

Use of the interim altitude function will ensure that the data block reflects the actual status of the aircraft and eliminate superfluous altitude updates.

5-14-4. ENTRY OF REPORTED ALTITUDE

Whenever Mode C altitude information is either not available or is unreliable, enter reported altitudes into the computer as follows:

NOTE-

Altitude updates are required to assure maximum accuracy in applying slant range correction formulas.

- a. When an aircraft reaches the assigned altitude.
- b. When an aircraft at an assigned altitude is issued a clearance to climb or descend.
- c. A minimum of each 10,000 feet during climb to or descent from FL 180 and above.

5-14-5. SELECTED ALTITUDE LIMITS

The display of Mode C targets and limited data blocks is necessary for application of Merging Target Procedures. Sectors shall ensure the display of Mode C targets and data blocks by entering appropriate altitude limits and display filters to include, as a minimum, the altitude stratum of the sector plus:

- a. 1,200 feet above the highest and below the lowest altitude or flight level of the sector where 1,000 feet vertical separation is applicable; and

- b. 2,200 feet above the highest and below the lowest flight level of the sector where 2,000 feet vertical separation is applicable.

NOTE-

1. The data block, for purposes of this paragraph, must contain the beacon code and Mode C altitude at a minimum.

2. Exception to these requirements may be authorized for specific altitudes in certain ARTCC sectors if defined in appropriate facility directives and approved by the respective service area operations directorate.

REFERENCE-

FAAO 7110.65, Alignment Accuracy Check, Para 5-1-2

5-14-6. SECTOR ELIGIBILITY

The use of the OK function is allowed to override sector eligibility only when one of the following conditions is met:

- a. Prior coordination is effected.
- b. The flight is within the control jurisdiction of the sector.

5-14-7. COAST TRACKS

Do not use coast tracks in the application of either radar or nonradar separation criteria.

5-14-8. CONTROLLER INITIATED COAST TRACKS

a. Initiate coast tracks only in Flight Plan Aided Tracking (FLAT) mode, except "free" coast tracking may be used as a reminder that aircraft without corresponding computer-stored flight plan information are under your control.

NOTE-

1. To ensure tracks are started in FLAT mode, perform a start track function at the aircraft's most current reported position, then immediately "force" the track into coast tracking by performing another start function with "CT" option in field 64. Making amendments to the stored route with trackball entry when the aircraft is rerouted, and repositioning the data block to coincide with the aircraft's position reports are methods of maintaining a coast track in FLAT mode.

2. DARC does not have the capability to initiate coast tracks.

b. Prior to initiating a coast track, ensure the following:

1. A departure message or progress report corresponding with the aircraft's current position is entered into the computer.

2. The track being started is within the Posted Time Update Interval (PTUI) of the aircraft's computer-estimated position and the Flight Plan Track Position Difference (FTPD) distance of the aircraft's flight plan route.

NOTE-

FTPD is an automation parameter, normally set to 15 miles, that is compared with the tracked target's perpendicular distance from the stored flight plan route. If the track is within the parameter miles, it is eligible for "FLAT tracking." PTUI is an automation parameter, normally set to 3 minutes, that is compared against the difference between the calculated time of arrival and the actual time of arrival over a fix. If the difference is greater than PTUI, the flight plan's stored data will be revised and fix-time update messages will be generated.

c. As soon as practicable after the aircraft is in radar surveillance, initiate action to cause radar tracking to begin on the aircraft.

Section 15. Automated Radar Terminal Systems (ARTS)– Terminal

5–15–1. APPLICATION

ARTS/STARS may be used for identifying aircraft assigned a discrete beacon code, maintaining identity of targets, and performing handoffs of these targets between controllers.

NOTE–

USAF/USN. Where PIDP/DAIR equipment is capable of performing the functions described in this section, it may be used accordingly.

5–15–2. RESPONSIBILITY

This equipment does not relieve the controller of the responsibility to ensure proper identification, maintenance of identity, handoff of the correct target associated with the alphanumeric data, and separation of aircraft.

5–15–3. FUNCTIONAL USE

In addition to other uses specified herein, terminal automation may be used for the following functions:

- a. Tracking.
- b. Tagging.
- c. Handoff.
- d. Altitude information.

REFERENCE–

FAAO 7110.65, Altitude Filters, Para 5–2–23

- e. Coordination.
- f. Ground speed.
- g. Identification.

5–15–4. SYSTEM REQUIREMENTS

Use terminal automation systems as follows:

NOTE–

Locally developed procedures, operating instructions, and training material are required because of differences in equipment capability. Such locally developed procedures shall be supplemental to those contained in this section and shall be designed to make maximum use of the ARTS equipment.

a. Inform all appropriate positions before terminating or reinstating use of the terminal automation system at a control position. When terminating the use of terminal automation systems, all pertinent flight data of that position shall be transferred or terminated.

b. Inform other interfaced facilities of scheduled and unscheduled shutdowns.

c. Initiate a track/tag on all aircraft to the maximum extent possible. As a minimum, aircraft identification should be entered, and automated handoff functions should be used.

d. Assigned altitude, if displayed, shall be kept current at all times. Climb and descent arrows, where available, shall be used to indicate other than level flight.

e. The automatic altitude readout of an aircraft under another controller's jurisdiction may be used for vertical separation purposes without verbal coordination provided:

1. Operation is conducted using single site radar coverage.

2. Prearranged coordination procedures are contained in a facility directive in accordance with para 5–4–10, Prearranged Coordination, and FAAO 7210.3, para 3–7–7, Prearranged Coordination.

3. Do not use Mode C to effect vertical separation within a Mosaic radar configuration.

5–15–5. INFORMATION DISPLAYED

a. Two-letter ICAO designators or three-letter designators, as appropriate, shall be used unless program limitations dictate the use of a single letter alpha prefix.

b. Use of the inhibit/select functions to remove displayed information no longer required shall be in accordance with local directives, which should ensure maximum required use of the equipment.

c. Information displayed shall be in accordance with national orders and specified in local directives.

5-15-6. CA/MCI

a. When a CA or MCI alert is displayed, evaluate the reason for the alert without delay and take appropriate action.

REFERENCE-

FAAO 7110.65, Safety Alert, Para 2-1-6

b. If another controller is involved in the alert, initiate coordination to ensure an effective course of action. Coordination is not required when immediate action is dictated.

c. Suppressing/Inhibiting CA/MCI alert.

1. The suppress function may be used to suppress the display of a specific CA/MCI alert.

2. The inhibit function shall only be used to inhibit the display of CA for aircraft routinely engaged in operations where standard separation criteria do not apply.

NOTE-

Examples of operations where standard separation criteria do not apply are ADC practice intercept operations and air shows.

3. Computer entry of a message suppressing a CA/MCI alert constitutes acknowledgment for the alert and signifies that appropriate action has or will be taken.

4. CA/MCI alert may not be suppressed or inhibited at or for another control position without being coordinated.

5-15-7. INHIBITING MINIMUM SAFE ALTITUDE WARNING (MSAW)

a. Inhibit MSAW processing of VFR aircraft and aircraft that cancel instrument flight rules (IFR) flight plans unless the pilot specifically requests otherwise.

REFERENCE-

FAAO 7110.65, VFR Aircraft in Weather Difficulty, Para 10-2-7

FAAO 7110.65, Radar Assistance to VFR Aircraft in Weather Difficulty, Para 10-2-8

b. A low altitude alert may be suppressed from the control position. Computer entry of the suppress message constitutes an acknowledgment for the alert and indicates that appropriate action has or will be taken.

5-15-8. TRACK SUSPEND FUNCTION

Use the track suspend function only when data block overlap in holding patterns or in proximity of the final approach create an unworkable situation. If necessary to suspend tracks, those which are not displaying automatic altitude readouts shall be suspended. If the condition still exists, those displaying automatic altitude readouts may then be suspended.

Section 16. TPX-42- Terminal

5-16-1. APPLICATION

Each TPX-42 facility shall utilize the equipment to the maximum extent possible consistent with local operating conditions.

5-16-2. RESPONSIBILITY

This equipment does not relieve the controller of the responsibility to ensure proper identification, maintenance of identity, handoff of the correct radar beacon target associated with numeric data, and the separation of aircraft.

5-16-3. FUNCTIONAL USE

TPX-42 may be used for the following functions:

- a. Tagging.
- b. Altitude information.

REFERENCE-

FAAO 7110.65, *Altitude Filters, Para 5-2-23*

- c. Coordination.
- d. Target identity confirmation.

5-16-4. SYSTEM REQUIREMENTS

Use the TPX-42 system as follows:

- a. TPX-42 facilities shall inform adjacent facilities of scheduled and unscheduled shutdowns.
- b. To the maximum extent practicable, tags should be utilized for all controlled aircraft.

5-16-5. INFORMATION DISPLAYED

- a. Inhibiting portions of the tag shall be in accordance with facility directives, which shall ensure maximum required use of the equipment.
- b. Mode C altitude information shall not be inhibited unless a ground malfunction causes repeated discrepancies of 300 feet or more between the automatic altitude readouts and pilot reported altitudes.

5-16-6. INHIBITING LOW ALTITUDE ALERT SYSTEM (LAAS)

Assign a beacon code to a VFR aircraft or to an aircraft that has canceled its IFR flight plan to inhibit LAAS processing unless the aircraft has specifically requested LAAS.

Chapter 6. Nonradar

Section 1. General

6-1-1. DISTANCE

Use mileage-based (DME and/or LTD) procedures and minima only when direct pilot/controller communications are maintained.

6-1-2. NONRECEIPT OF POSITION REPORT

When a position report affecting separation is not received, take action to obtain the report no later than 5 minutes after the aircraft was estimated over the fix.

REFERENCE-
FAAO 7110.65, IFR Military Training Routes, Para 9-3-7

6-1-3. DUPLICATE POSITION REPORTS

Do not require an aircraft to make the same position report to more than one facility.

6-1-4. ADJACENT AIRPORT OPERATION

TERMINAL

WAKE TURBULENCE APPLICATION

The ATC facility providing service to heavy jets/B757s and having control jurisdiction at adjacent airports shall separate arriving or departing IFR aircraft on a course that will cross behind the flight path of a heavy jet/B757 - 2 minutes.
(See FIG 6-1-1 and FIG 6-1-2.)

FIG 6-1-1

Adjacent Airport Operation -- Arrival

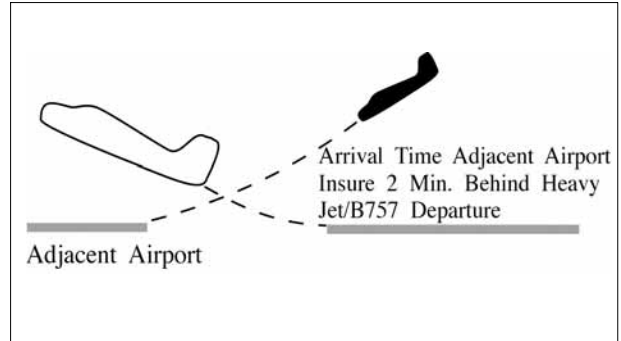
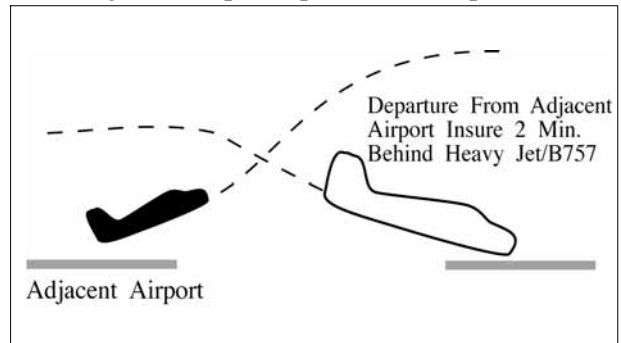

FIG 6-1-2

Adjacent Airport Operation -- Departure



6-1-5. ARRIVAL MINIMA

TERMINAL

WAKE TURBULENCE APPLICATION

Separate IFR aircraft landing behind an arriving heavy jet/B757 by 2 minutes when arriving:

- a. The same runway (use 3 minutes for a small aircraft behind a heavy jet/B757).
- b. A parallel runway separated by less than 2,500 feet.

c. A crossing runway if projected flight paths will cross. (See FIG 6-1-3.)

FIG 6-1-3

Arrival Minima

Landing Behind an Arriving Heavy Jet/B757

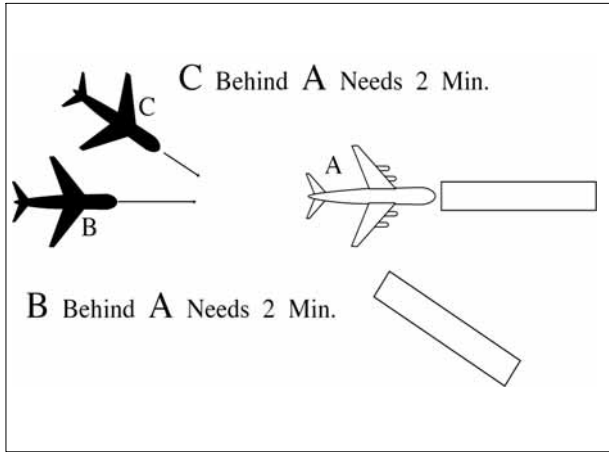

Section 2. Initial Separation of Successive Departing Aircraft

6-2-1. MINIMA ON DIVERGING COURSES

Separate aircraft that will fly courses diverging by 45 degrees or more after departing the same or adjacent airports by use of one of the following minima:

NOTE-

1. Consider known aircraft performance characteristics when applying initial separation to successive departing aircraft.

2. When one or both of the departure surfaces is a helipad, use the takeoff course of the helicopter as a reference, comparable to the centerline of a runway and the helipad center as the threshold.

a. When aircraft will fly diverging courses:

1. Immediately after takeoff – 1 minute until courses diverge. (See FIG 6-2-1.)

2. Within 5 minutes after takeoff– 2 minutes until courses diverge. (See FIG 6-2-2.)

**FIG 6-2-2
Minima on Diverging Courses**

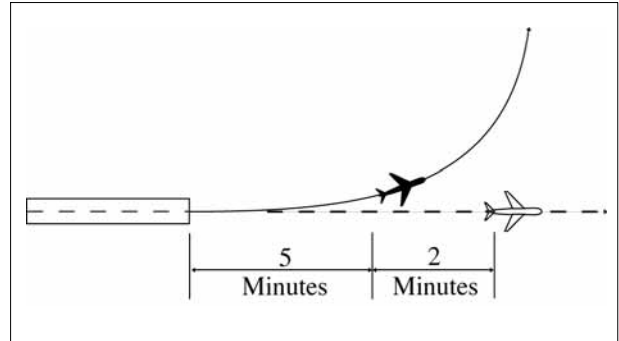

3. Within 13 miles DME/LTD after takeoff – 3 miles until courses diverge. (See FIG 6-2-3.)

**FIG 6-2-1
Minima on Diverging Courses**

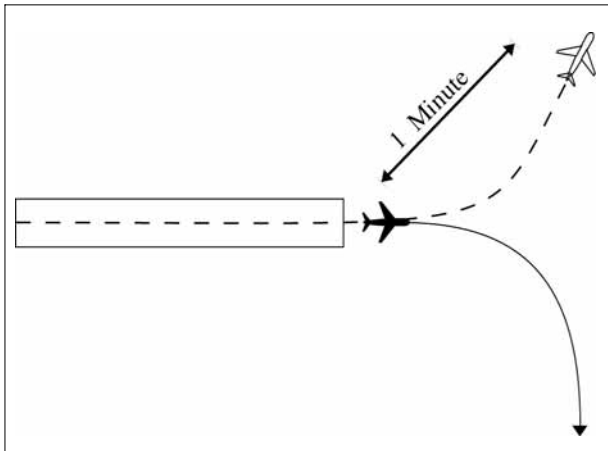

**FIG 6-2-3
Minima on Diverging Courses**

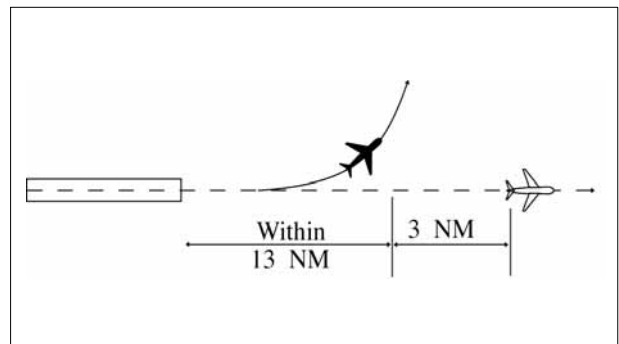

b. TERMINAL. Between aircraft departing in the same direction from different runways whose centerlines are parallel and separated by at least 3,500 feet, authorize simultaneous takeoffs when the aircraft will fly diverging courses immediately after takeoff. (See FIG 6-2-4.)

FIG 6-2-4

Minima on Diverging Courses

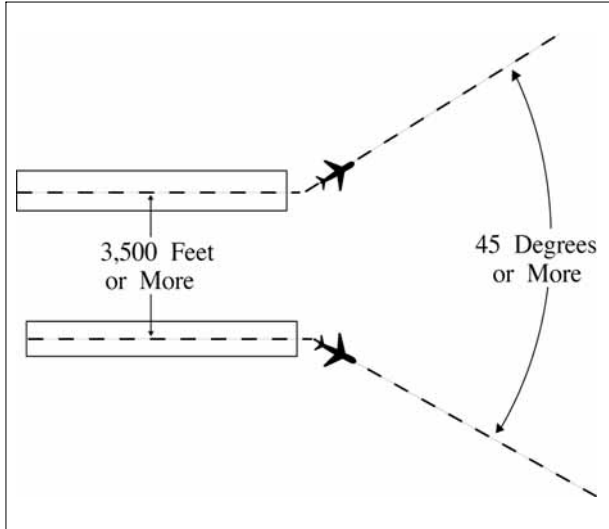

c. TERMINAL. Between aircraft that will fly diverging courses immediately after takeoff from diverging runways: (See FIG 6-2-5.)

1. Nonintersecting runways. Authorize simultaneous takeoffs when either of the following conditions exist:

(a) The runways diverge by 30 degrees or more.

(b) The distance between runway centerlines at and beyond the points where takeoffs begin is at least:

(1) 2,000 feet and the runways diverge by 15 to 29 degrees inclusive.

(2) 3,500 feet and the runways diverge by less than 15 degrees.

FIG 6-2-5

Minima on Diverging Courses

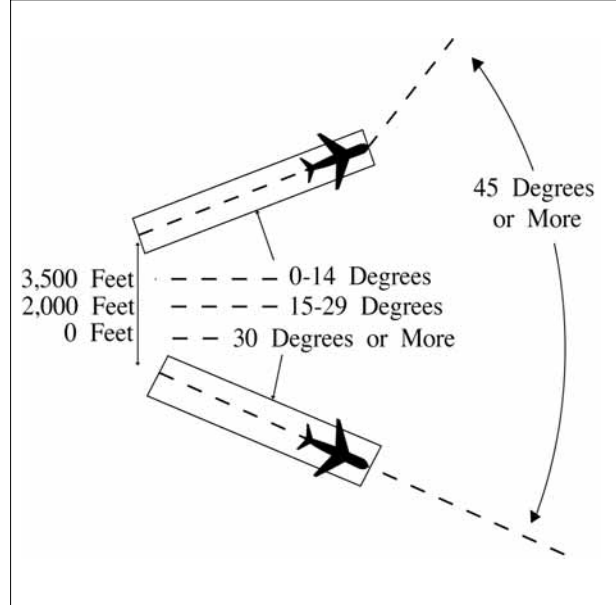

2. Intersecting runways. Authorize takeoff of a succeeding aircraft when the preceding aircraft has passed the point of runway intersection, and

(a) The runways diverge by 30 degrees or more. (See FIG 6-2-6.)

FIG 6-2-6

Minima on Diverging Courses

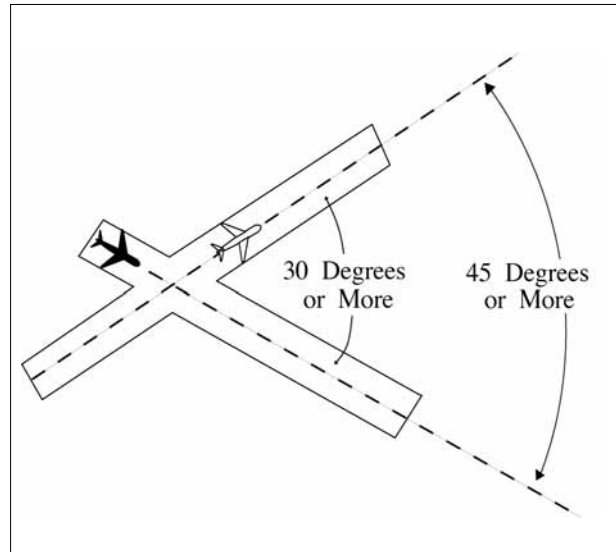

(b) The runways diverge by 15 to 29 degrees inclusive and the preceding aircraft has commenced a turn. (See FIG 6-2-7.)

FIG 6-2-7

Minima on Diverging Courses

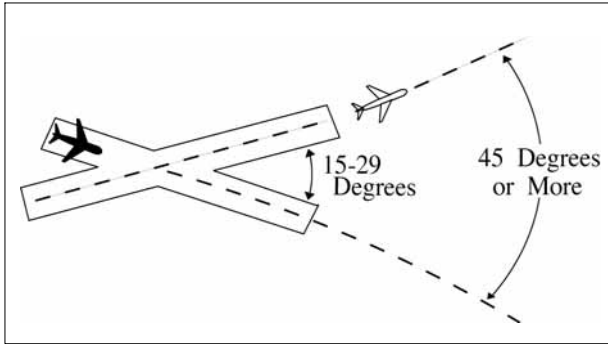

6-2-2. MINIMA ON SAME COURSE

Separate aircraft that will fly the same course when the following aircraft will climb through the altitude assigned to the leading aircraft by using a minimum of 3 minutes until the following aircraft passes through the assigned altitude of the leading aircraft; or 5 miles between DME equipped aircraft; RNAV equipped aircraft using LTD; and between DME and LTD aircraft provided the DME aircraft is either

10,000 feet or below or outside of 10 miles from the DME NAVAID. (See FIG 6-2-8 and FIG 6-2-9.)

FIG 6-2-8

Minima on Same Course

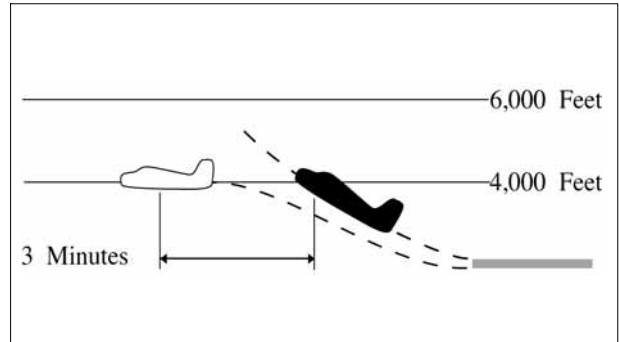
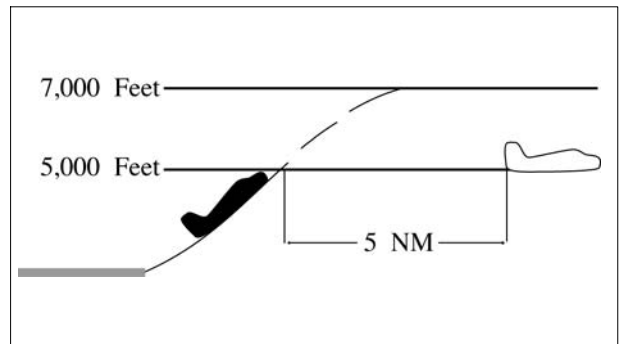

FIG 6-2-9

Minima on Same Course



Section 3. Initial Separation of Departing and Arriving Aircraft

6-3-1. SEPARATION MINIMA

Separate a departing aircraft from an arriving aircraft making an instrument approach to the same airport by using one of the following minima until vertical or lateral separation is achieved:

a. TERMINAL. When takeoff direction differs by at least 45 degrees from the reciprocal of the final approach course, the departing aircraft takes off before the arriving aircraft leaves a fix inbound not less than 4 miles from the airport.

b. TERMINAL. When takeoff direction is other than in subpara a, the departing aircraft takes off so that it is established on a course diverging by at least 45 degrees from the reciprocal of the final approach course before the arriving aircraft leaves a fix inbound not less than 4 miles from the airport.

c. TERMINAL. When the absence of an appropriate fix precludes the application of subparas a or b and at airports where approach control service is not provided, the separation in subparas d or e shall be applied.

d. When takeoff direction differs by at least 45 degrees from the reciprocal of the final approach course, the departing aircraft takes off 3 minutes before the arriving aircraft is estimated at the airport. (See FIG 6-3-1.)

e. When takeoff direction is other than in subpara d, the departing aircraft takes off so that it is established on a course diverging by at least 45 degrees from the reciprocal of the final approach course 5 minutes before the arriving aircraft is estimated at the airport or before it starts procedure turn. (See FIG 6-3-2 and FIG 6-3-3.)

FIG 6-3-2

Separation Minima

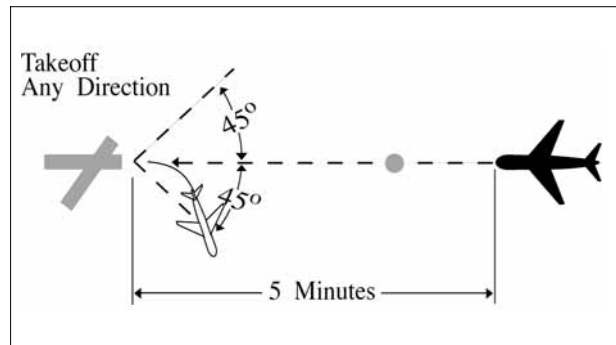

FIG 6-3-3

Separation Minima

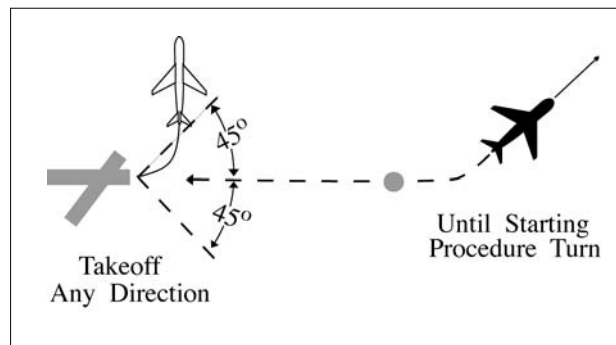
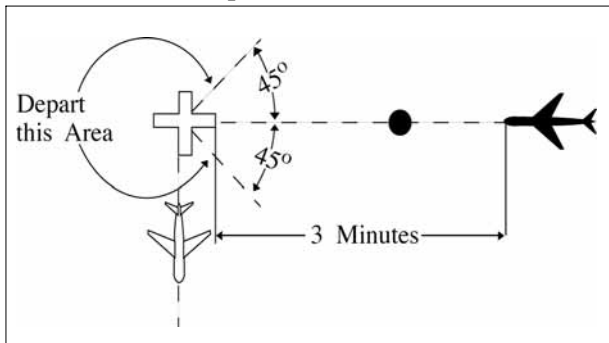

FIG 6-3-1

Separation Minima



Section 4. Longitudinal Separation

6-4-1. APPLICATION

Separate aircraft longitudinally by requiring them to do one of the following, as appropriate:

- a. Depart at a specified time.
- b. Arrive at a fix at a specified time.

PHRASEOLOGY-

CROSS (fix) AT OR BEFORE (time).

CROSS (fix) AT OR AFTER (time).

- c. Hold at a fix until a specified time.
- d. Change altitude at a specified time or fix.

REFERENCE-

FAAO 7110.65, *Altitude Information, Para 4-5-7*

6-4-2. MINIMA ON SAME, CONVERGING, OR CROSSING COURSES

Separate aircraft on the same, converging, or crossing courses by an interval expressed in time or distance, using the following minima:

- a. When the leading aircraft maintains a speed at least 44 knots faster than the following aircraft – 5 miles between DME equipped aircraft; RNAV equipped aircraft using LTD; and between DME and LTD aircraft provided the DME aircraft is either 10,000 feet or below or outside of 10 miles from the DME NAVAID, or 3 minutes between other aircraft if, in either case, one of the following conditions is met:

1. A departing aircraft follows a preceding aircraft which has taken off from the same or adjacent airport. (See FIG 6-4-1.)

FIG 6-4-1

Minima on Same Course 44 Knots or More Separation

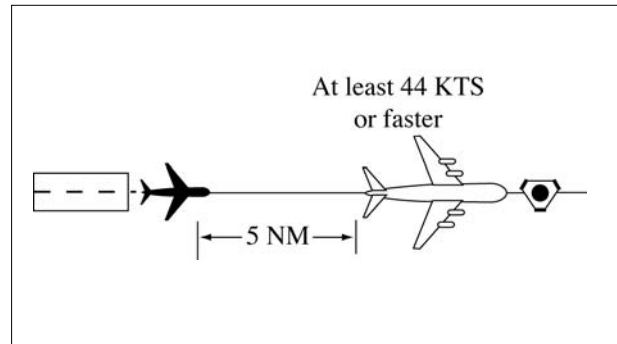

2. A departing aircraft follows a preceding en route aircraft which has reported over a fix serving the departure airport. (See FIG 6-4-2.)

FIG 6-4-2

Minima on Converging Courses 44 Knots or More Separation

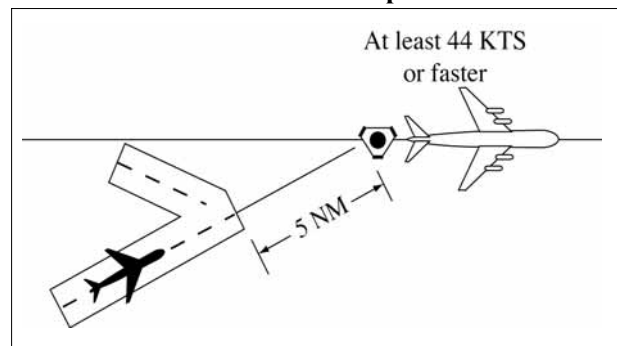

3. An en route aircraft follows a preceding en route aircraft which has reported over the same fix. (See FIG 6-4-3.)

FIG 6-4-3

**Minima on Crossing Courses
44 Knots or More Separation**

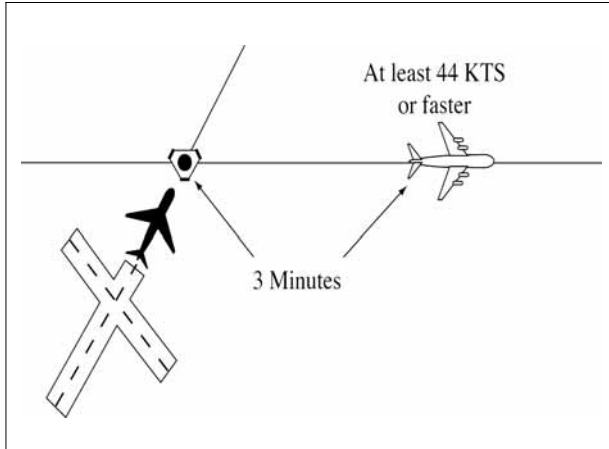

b. When the leading aircraft maintains a speed at least 22 knots faster than the following aircraft – 10 miles between DME equipped aircraft; RNAV equipped aircraft using LTD; and between DME and LTD aircraft provided the DME aircraft is either 10,000 feet or below or outside of 10 miles from the DME NAVAID; or 5 minutes between other aircraft if, in either case, one of the following conditions exists:

1. A departing aircraft follows a preceding aircraft which has taken off from the same or an adjacent airport. (See FIG 6-4-4.)

FIG 6-4-4

**Minima on Same Course
22 Knots or More Separation**

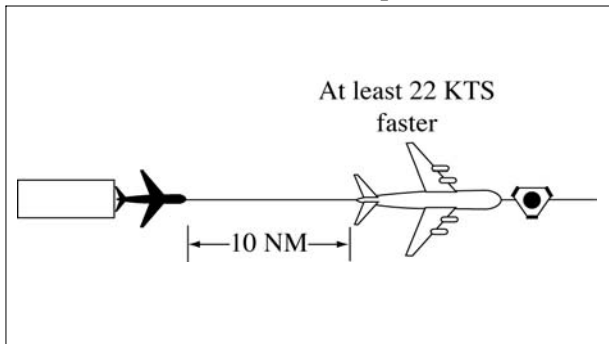

2. A departing aircraft follows a preceding en route aircraft which has reported over a fix serving the departure airport. (See FIG 6-4-5.)

FIG 6-4-5

**Minima on Converging Courses
22 Knots or More Separation**

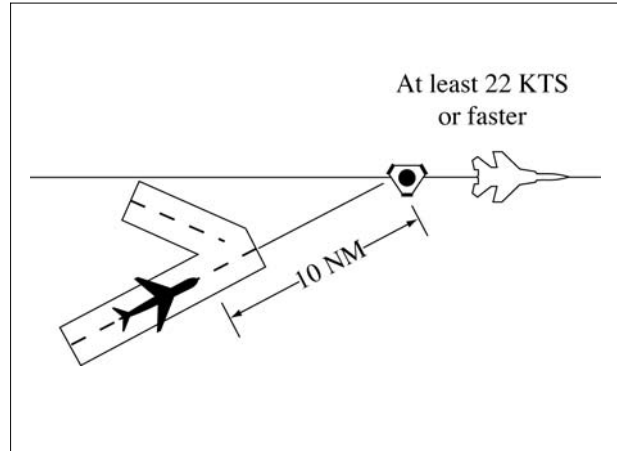

3. An en route aircraft follows a preceding en route aircraft which has reported over the same fix. (See FIG 6-4-6.)

FIG 6-4-6

**Minima on Crossing Courses
22 Knots or More Separation**

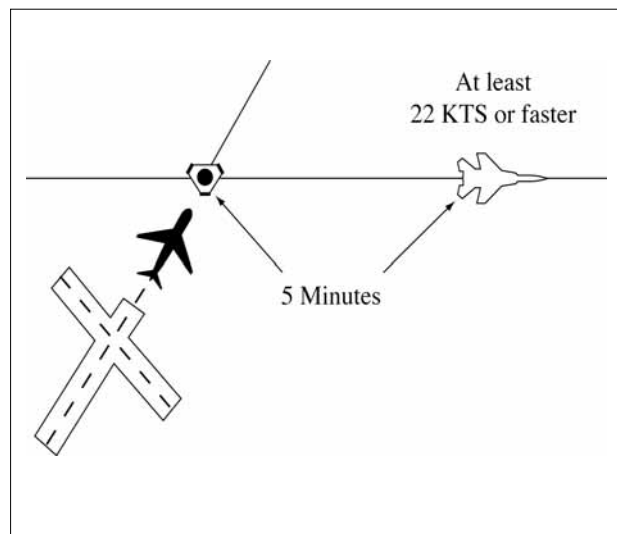

c. When an aircraft is climbing or descending through the altitude of another aircraft:

1. Between DME equipped aircraft; RNAV equipped aircraft using LTD; and between DME and LTD aircraft provided the DME aircraft is either 10,000 feet or below or outside of 10 miles from the DME NAVAID— 10 miles, if the descending aircraft is leading or the climbing aircraft is following. (See FIG 6-4-7 and FIG 6-4-8.)

FIG 6-4-7
Descending Through Another Aircraft's Altitude DME Separation

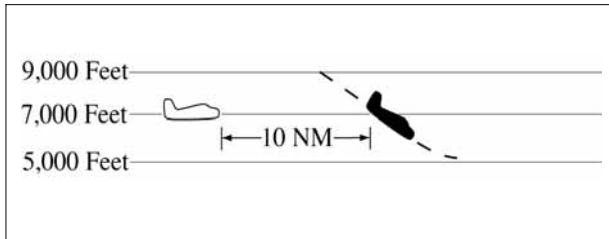
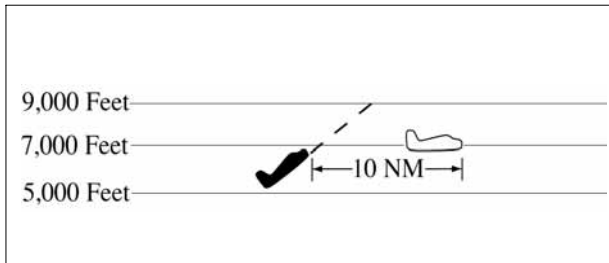

FIG 6-4-8
Climbing Through Another Aircraft's Altitude DME Separation



2. Between other aircraft— 5 minutes, if all of the following conditions are met: (See FIG 6-4-9 and FIG 6-4-10.)

(a) The descending aircraft is leading or the climbing aircraft is following.

(b) The aircraft are separated by not more than 4,000 feet when the altitude change started.

(c) The change is started within 10 minutes after a following aircraft reports over a fix reported over by the leading aircraft or has acknowledged a clearance specifying the time to cross the same fix.

3. Between RNAV aircraft that are operating along an RNAV route that is eight miles or less in width— 10 miles provided the following conditions are met:

(a) The descending aircraft is leading or the climbing aircraft is following.

(b) The aircraft were separated by not more than 4,000 feet when the altitude change started.

FIG 6-4-9
Descending Through Another Aircraft's Altitude Timed Separation

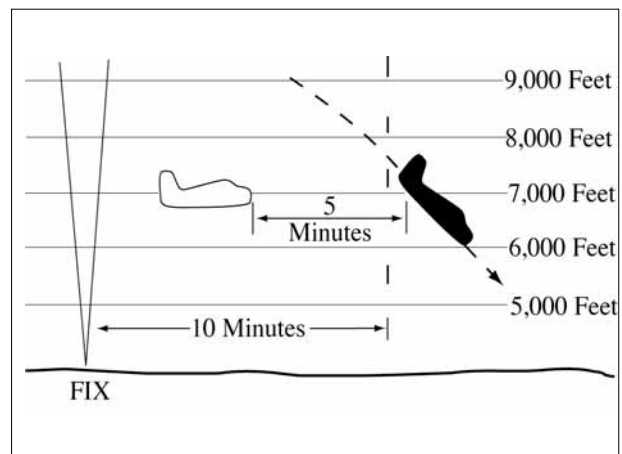
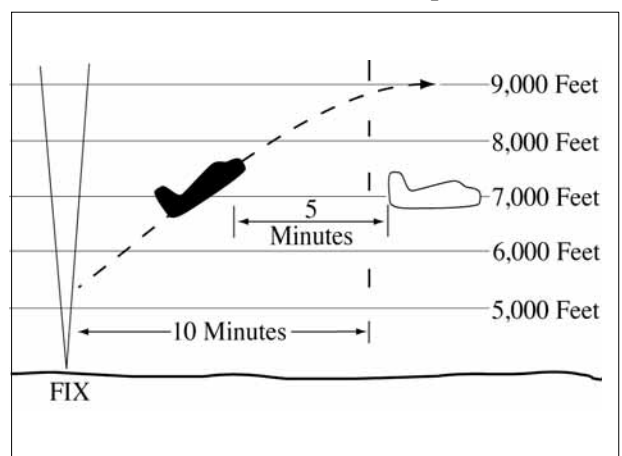
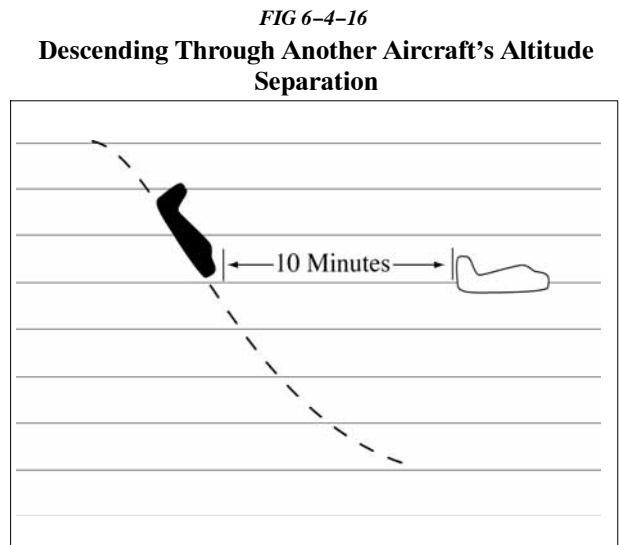
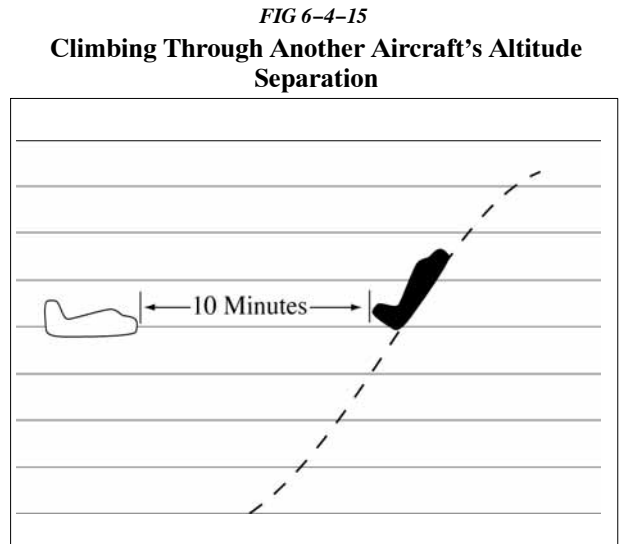
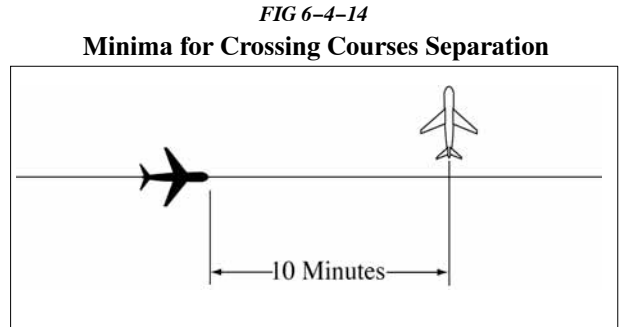
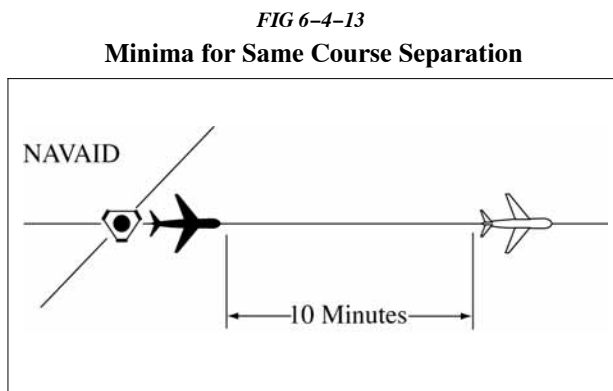
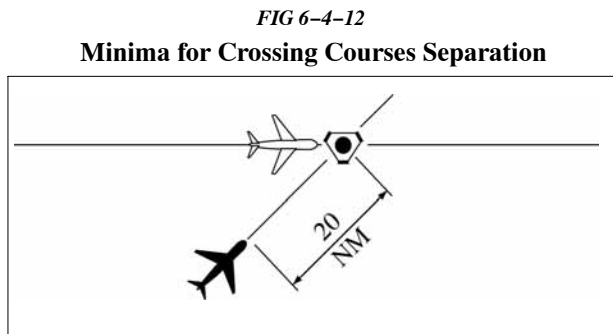
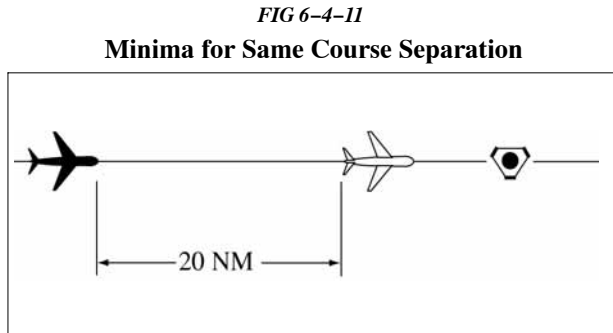

FIG 6-4-10
Climbing Through Another Aircraft's Altitude Timed Separation



d. When the conditions of subparas a, b, or c cannot be met— 20 miles between DME equipped aircraft; RNAV equipped aircraft using LTD; and between DME and LTD aircraft provided the DME aircraft is either 10,000 feet or below or outside of 10 miles from the DME NAVAID; or 10 minutes between other aircraft.
 (See FIG 6-4-11, FIG 6-4-12, FIG 6-4-13, FIG 6-4-14, FIG 6-4-15, and FIG 6-4-16.)



e. Between aircraft, when one aircraft is using DME/LTD and the other is not— 30 miles if both the following conditions are met:
(See FIG 6-4-17 and FIG 6-4-18.)

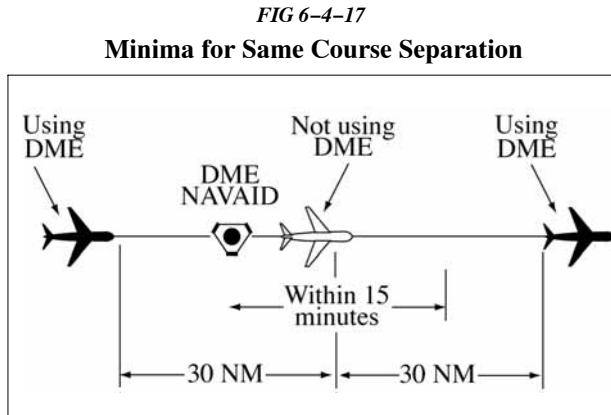
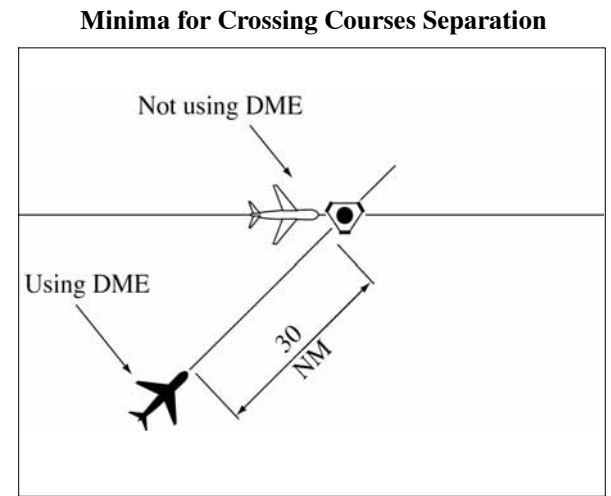

FIG 6-4-18



1. The aircraft using DME/LTD derives distance information by reference to the same NAVAID or waypoint over which the aircraft not using DME/LTD has reported.

2. The aircraft not using DME/LTD is within 15 minutes of the NAVAID.

6-4-3. MINIMA ON OPPOSITE COURSES

Separate aircraft traveling opposite courses by assigning different altitudes consistent with the approved vertical separation from 10 minutes before, until 10 minutes after they are estimated to pass. Vertical separation may be discontinued after one of the following conditions is met: (See FIG 6-4-19.)

FIG 6-4-19
Minima for Opposite Courses Separation

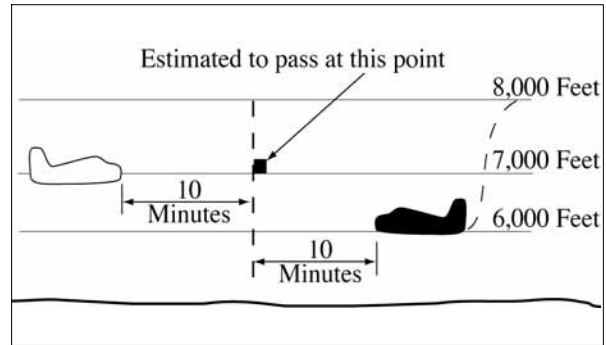

NOTE-
RNAV route segments that have been expanded in the proximity to reference facilities for slant-range effect are not to be considered “expanded” for purposes of applying separation criteria in this paragraph.

a. Both aircraft have reported passing NAVAIDs, DME fixes, or waypoints indicating they have passed each other. (See FIG 6-4-20.)

FIG 6-4-20
Minima for Opposite Courses Separation

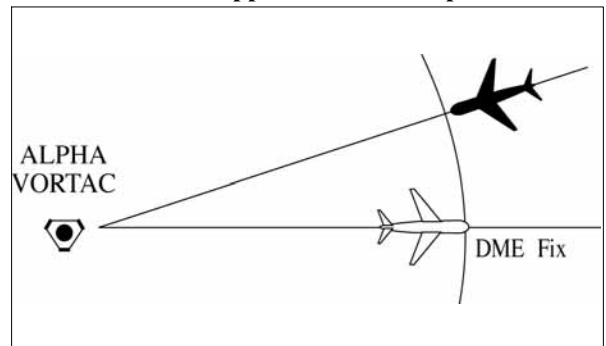

NOTE-
It is not intended to limit application of this procedure only to aircraft operating in opposite directions along the same airway or radial. This procedure may also be applied to aircraft established on diverging airways or radials of the same NAVAID.

b. Both aircraft have reported passing the same intersection/waypoint and they are at least 3 minutes apart.

c. Two RNAV aircraft have reported passing the same position and are at least 8 miles apart if operating along a route that is 8 miles or less in width; or 18 miles apart if operating along an expanded route; except that 30 miles shall be applied if operating along that portion of any route segment defined by a navigation station requiring extended usable distance limitations beyond 130 miles.

d. An aircraft utilizing RNAV and an aircraft utilizing VOR have reported passing the same position and the RNAV aircraft is at least *4 miles* beyond the reported position when operating along a route that is 8 miles or less in width; *9 miles* beyond the point when operating along an expanded route; except that *15 miles* shall be applied if operating along that portion of any route segment defined by a navigation station requiring extended usable distance limitation beyond 130 miles; or *3 minutes* apart whichever is greater.

6-4-4. SEPARATION BY PILOTS

When pilots of aircraft on the same course in direct radio communication with each other concur, you may authorize the following aircraft to maintain longitudinal separation of *10 minutes*; or *20 miles* between DME equipped aircraft; RNAV equipped aircraft using LTD; and between DME and LTD

aircraft provided the DME aircraft is either 10,000 feet or below or outside of 10 miles from the DME NAVAID.

PHRASEOLOGY-

MAINTAIN AT LEAST ONE ZERO MINUTES/TWO ZERO MILES SEPARATION FROM (ident).

6-4-5. RNAV AIRCRAFT ALONG VOR AIRWAYS/ROUTES

Advise the pilot to use DME distances when applying DME separation to an RNAV aircraft operating along VOR airways/routes.

PHRASEOLOGY-

USE DME DISTANCES.

NOTE-

Along Track Distance derived from area navigation devices having slant-range correction will not coincide with the direct DME readout.

Section 5. Lateral Separation

6-5-1. SEPARATION METHODS

Separate aircraft by one of the following methods:

- a. Clear aircraft on different airways or routes whose widths or protected airspace do not overlap.
- b. Clear aircraft below 18,000 to proceed to and report over or hold at different geographical locations determined visually or by reference to NAVAIDs.
- c. Clear aircraft to hold over different fixes whose holding pattern airspace areas do not overlap each other or other airspace to be protected.
- d. Clear departing aircraft to fly specified headings which diverge by at least 45 degrees.

6-5-2. MINIMA ON DIVERGING RADIALS

- a. Consider separation to exist between aircraft:
 1. Established on radials of the same NAVAID that diverge by at least 15 degrees when either aircraft is clear of the airspace to be protected for the other aircraft.
 2. With non-VOR/DME based navigational equipment established on tracks of the same waypoint that diverge by at least 15 degrees when either aircraft is clear of the airspace to be protected for the other aircraft.

FIG 6-5-1

Minima on Diverging Radials

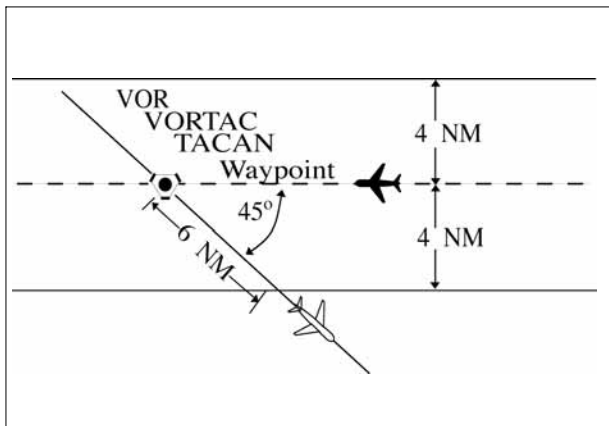

NOTE-
The procedure may be applied to converging as well as diverging aircraft. (See FIG 6-5-1.) The aircraft depicted 6 miles from the NAVAID/waypoint would require vertical

separation until reaching the 6-mile point. Reversing direction, the same aircraft would require vertical separation before passing the 6-mile point. Due to the nature of GPS equipment, issue crossing restrictions in reference to the next waypoint, since the pilot receives tracking "to" data rather than tracking "from" the last waypoint.

- b. Use TBL 6-5-1 and TBL 6-5-2 to determine the distance required for various divergence angles to clear the airspace to be protected. For divergence that falls between two values, use the lesser divergence value to obtain the distance.

TBL 6-5-1

**Non-DME Divergence
Distance Minima**

Divergence (Degrees)	Distance (NM)
15	16
20	12
25	10
30	8
35	7
45	6
55	5
90	4

NOTE: This table is for non-DME application only.

TBL 6-5-2

**Divergence
Distance Minima**

Divergence (Degrees)	Distance (NM)	
	Below FL 180	Fl 180 through FL 450
15	17	18
20	13	15
25	11	13
30	9	11
35	8	11
45	7	11
55	6	11
90	5	11

NOTE: This table is for DME application and compensates for DME slant-range error.

NOTE-

For altitudes of 3,000 feet or less above the elevation of the NAVAID, DME slant-range error is negligible and the values in TBL 6-5-1 may be used.

6-5-3. DME ARC MINIMA

Apply lateral DME separation by requiring aircraft using DME to fly an arc about a NAVAID at a specified distance using the following minima:
(See FIG 6-5-2.)

**FIG 6-5-2
DME Arc Minima**

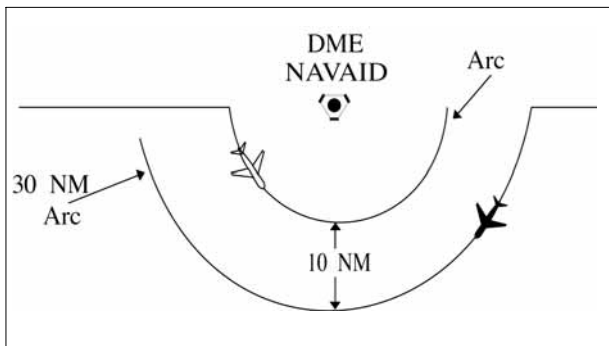

REFERENCE-

FAAO 7110.65, NAVAID Terms, Para 2-5-2

a. Between different arcs about a NAVAID regardless of direction of flight:

1. At 35 miles or less from the NAVAID-10 miles.
2. More than 35 miles from the NAVAID-20 miles.

b. Between an arc about a NAVAID and other airspace to be protected: (See FIG 6-5-3.)

FIG 6-5-3

DME Arc Minima

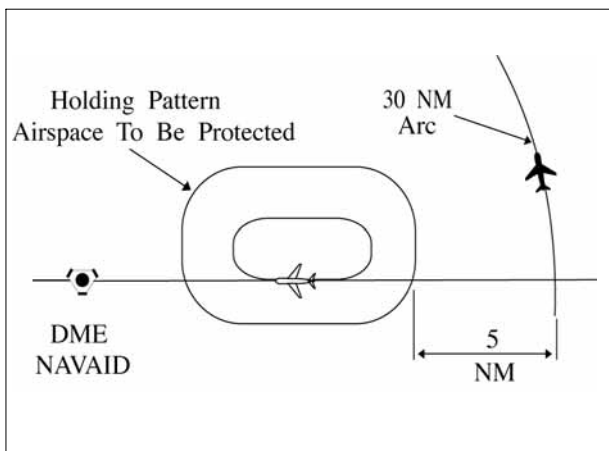

NOTE-

The other airspace to be protected may be a MOA, a holding pattern, airway or route, ATCAA, Warning Area, Restricted Area, Prohibited Area, etc.

1. At 35 miles or less from the NAVAID-5 miles.
2. More than 35 miles from the NAVAID-10 miles.

PHRASEOLOGY-

VIA (number of miles) MILE ARC (direction) OF (name of DME NAVAID).

6-5-4. MINIMA ALONG OTHER THAN ESTABLISHED AIRWAYS OR ROUTES

Protect airspace along other than established airways or routes as follows: (See FIG 6-5-4.)

FIG 6-5-4

Minima Along Other Than Established Airways or Routes

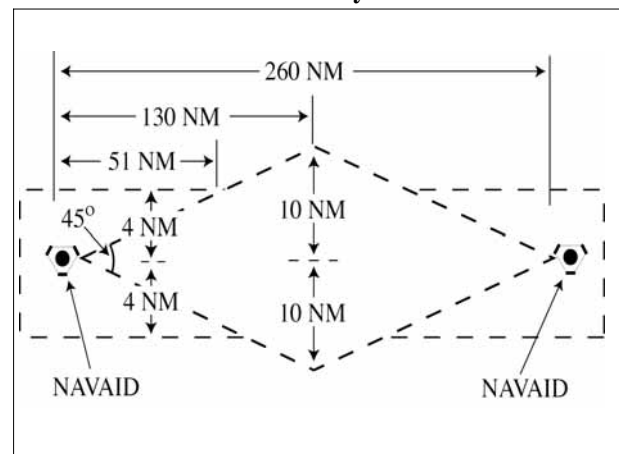

REFERENCE-

P/CG Term- Airway.

P/CG Term- Route.

a. Direct courses and course changes of 15 degrees or less:

1. Via NAVAIDS or radials FL 600 and below-4 miles on each side of the route to a point 51 miles from the NAVAID, then increasing in width on a 4 1/2 degree angle to a width of 10 miles on each side of the route at a distance of 130 miles from the NAVAID.

2. Via degree-distance fixes for aircraft authorized under para 4-4-3, Degree-Distance Route Definition for Military Operations.

(a) Below FL 180- 4 miles on each side of the route.

(b) FL 180 to FL 600 inclusive— 10 miles on each side of the route.

3. Via degree-distance fixes for RNAV flights above FL 450— 10 miles on each side of the route.

NOTE—
Degree-distance RNAV flight (random routes) at FL 450 and below are provided radar separation.

b. When course change is 16 degrees through 90 degrees, protect the airspace on the overflown side beginning at the point where the course changes as follows: (See FIG 6-5-5.)

FIG 6-5-5
Overflown Side Minima
16 to 90 Degrees

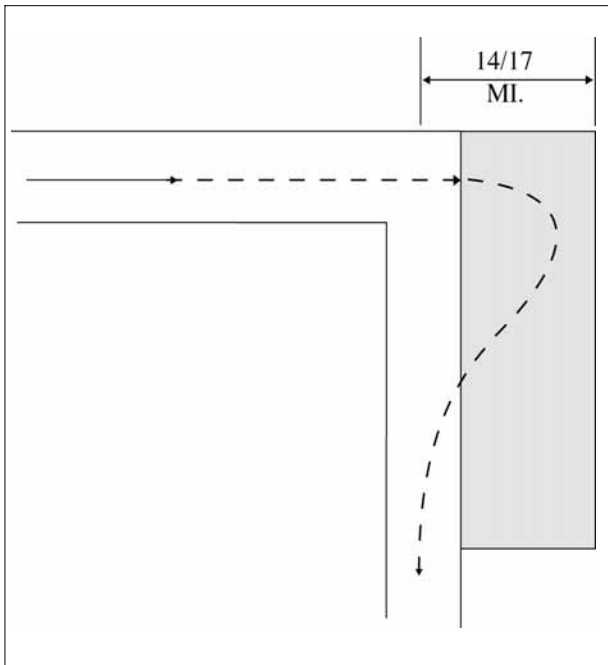

- 1. Below FL 180— same as subparas a1 or 2.
 - 2. FL 180 to FL 230 inclusive— 14 miles.
 - 3. Above FL 230 to FL 600 inclusive— 17 miles.
- c. When course change is 91 degrees through 180 degrees, protect the airspace on the overflown side beginning at the point where the course changes as follows: (See FIG 6-5-6.)

- 1. Below FL 180— same as subparas a1 or 2.
- 2. FL 180 to FL 230 inclusive— 28 miles.
- 3. Above FL 230 to FL 600 inclusive— 34 miles.

FIG 6-5-6
Overflown Side Minima
91 to 180 Degrees

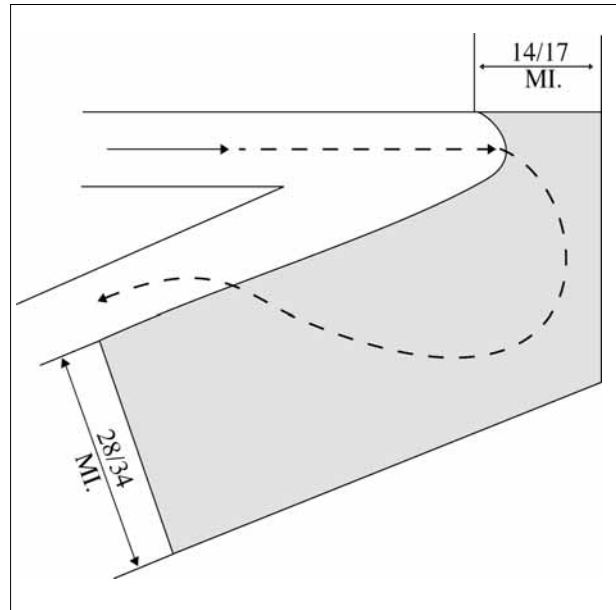

d. After the course changes specified in subparas b or c have been completed and the aircraft is back on course, the appropriate minima in subpara a may be used.

REFERENCE—
FAAO 7110.65, Military Operations Above FL 600, Para 9-3-13

6-5-5. RNAV MINIMA- DIVERGING/CROSSING COURSES

Consider lateral separation to exist when an RNAV aircraft is beyond the point where the lateral protected airspace of that aircraft has ceased to overlap the lateral protected airspace of another by at least:
(See FIG 6-5-7 and FIG 6-5-8.)

FIG 6-5-7

RNAV Minima

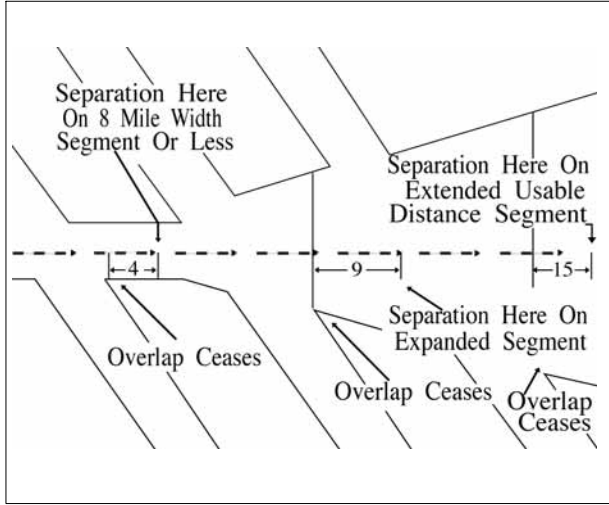

a. When operating along a route that is 8 miles or less in width- 4 miles.

b. When operating along an expanded route- 9 miles, except that 15 miles shall be applied along that portion of any route segment requiring extended usable distance limitation beyond 130 miles of the reference facility.

FIG 6-5-8

RNAV Minima

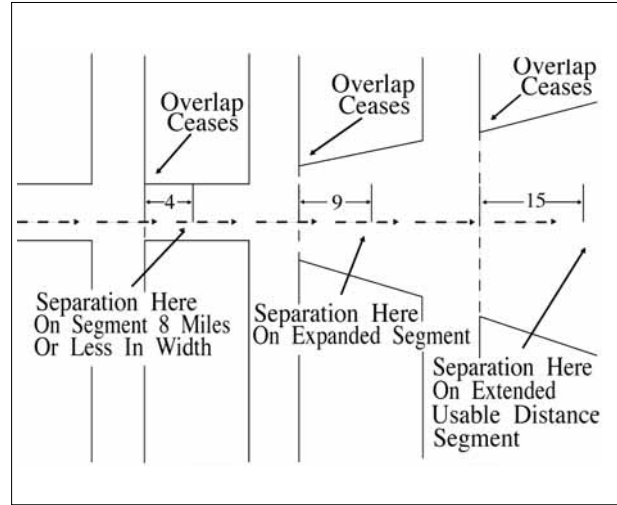

Section 6. Vertical Separation

6-6-1. APPLICATION

Assign an altitude to an aircraft after the aircraft previously at that altitude has reported leaving the altitude.

PHRASEOLOGY-

REPORT LEAVING/REACHING (altitude/flight level).

REPORT LEAVING ODD/EVEN ALTITUDES/FLIGHT LEVELS.

(If aircraft is known to be operating below the lowest useable flight level),

SAY ALTITUDE.

or

(If aircraft is known to be operating at or above the lowest useable flight level),

SAY FLIGHT LEVEL.

or

If aircraft's position relative to the lowest useable flight level is unknown),

SAY ALTITUDE OR FLIGHT LEVEL.

NOTE-

Consider known aircraft performance characteristics, pilot furnished and/or Mode C detected information which indicate that climb/descent will not be consistent with the rates recommended in the AIM.

REFERENCE-

FAAO 7110.65, Procedural Preference, Para 2-1-3

FAAO 7110.65, Vertical Separation Minima, Para 4-5-1

FAAO 7110.65, Separation, Para 7-7-3

FAAO 7110.65, Separation, Para 7-8-3

FAAO 7110.65, Separation, Para 7-9-4

6-6-2. EXCEPTIONS

Assign an altitude to an aircraft only after the aircraft previously at that altitude has reported at or passing through another altitude separated from the first by the appropriate minimum when:

- a. Severe turbulence is reported.
- b. Aircraft are conducting military aerial refueling.

REFERENCE-

FAAO 7110.65, Military Aerial Refueling, Para 9-3-12

- c. The aircraft previously at the altitude has been:
 1. Issued a clearance permitting climb/descent at pilot's discretion.
 2. Cleared to CRUISE (altitude). However, do not use Mode C to effect separation with an aircraft on a cruise clearance.

NOTE-

An aircraft assigned a cruise clearance is assigned a block of airspace from the minimum IFR altitude up to and including the assigned cruising altitude, and climb/descent within the block is at pilot's discretion. When the pilot verbally reports leaving an altitude in descent, he/she may not return to that altitude.

REFERENCE-

P/CG Term- Cruise.

6-6-3. SEPARATION BY PILOTS

When pilots of aircraft in direct radio communication with each other during climb and descent concur, you may authorize the lower aircraft, if climbing, or the upper aircraft, if descending, to maintain vertical separation.

Section 7. Timed Approaches

6-7-1. APPLICATION

Timed approaches using either nonradar procedures or radar vectors to the final approach course may be used at airports served by a tower if the following conditions are met:

NOTE-

These procedures require NAVAIDs and standard/special instrument approach procedures or adequate radar coverage which permit an aircraft to:

1. Hold at a fix located on the approach course or to be radar vectored to the final approach course for a straight-in approach in accordance with the minima specified in para 6-7-5 Interval Minima.

2. Proceed in the direction of the airport along the approach course crossing the holding/approach fix at a specified altitude if required.

3. Continue descent for an approach to destination airport.

a. Direct communication is maintained with the aircraft until the pilot is instructed to contact the tower.

b. If more than one missed approach procedure is available, none require course reversal.

c. If only one missed approach procedure is available, the following conditions are met:

1. Course reversal is not required.

2. Reported ceiling and visibility are equal to or greater than the highest prescribed circling minima for the instrument approach procedure in use.

NOTE-

Determination of whether or not an existing ceiling meets minima is accomplished by comparing MDA (MSL) with ceiling (AGL) plus the airport elevation.

REFERENCE-

FAAO 7110.65, Approach Sequence, Para 6-7-2

6-7-2. APPROACH SEQUENCE

When an aircraft passes the final approach fix inbound (nonprecision approach) or the outer marker or the fix used in lieu of the outer marker inbound (precision approach), issue clearances for a succeeding timed approach in accordance with the following:

REFERENCE-

FAAO 7110.65, Approach Separation Responsibility, Para 5-9-5

FAAO 7110.65, Level Flight Restriction, Para 6-7-4

FAAO 7110.65, Missed Approaches, Para 6-7-7

a. Clear the succeeding aircraft for approach, to descend to the altitude vacated by the preceding aircraft, and to leave the final approach fix inbound (nonprecision approach) or the outer marker or the fix used in lieu of the outer marker inbound (precision approach) at a specified time; or when using radar to sequence and position aircraft on the final approach course, vector aircraft to cross the final approach fix/outer marker or the fix used in lieu of the outer marker in compliance with para 6-7-5, Interval Minima.

FIG 6-7-1

Timed Approach Procedures Using ILS and Longitudinal Separation Only

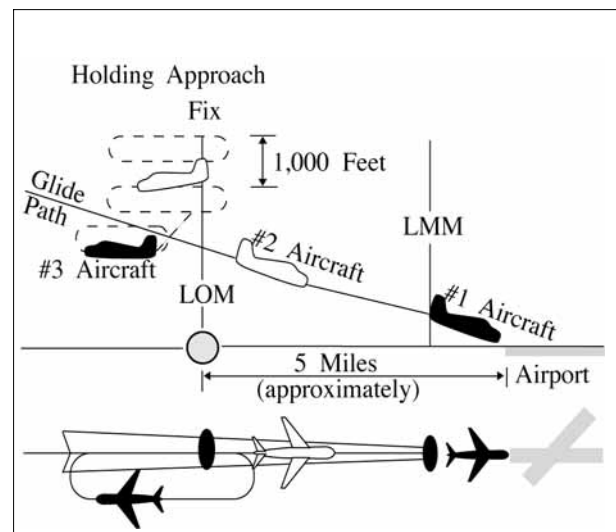

NOTE-

FIG 6-7-1 depicts the application of timed approach procedures using an ILS and applying longitudinal separation only. Using an interval of 2 minutes between successive approaches, the #1 and #2 aircraft have already passed the outer locator (LOM) on final approach, and the #3 aircraft has been cleared for approach and to depart the LOM 2 minutes after the #2 aircraft reported leaving the LOM inbound on final approach. After aircraft in the approach sequence depart the holding/approach fix (LOM) inbound, vertical separation is no longer provided and longitudinal separation is utilized.

REFERENCE-

FAAO 7110.65, Final Approach Course Interception, Para 5-9-2

b. If an alternative missed approach procedure is not available and weather conditions are less than required by para 6-7-1, Application, subpara c, clear the succeeding aircraft for an approach when the preceding aircraft has landed or canceled its IFR flight plan.

FIG 6-7-2

Timed Approach Procedures Using a Bearing on an NDB and Longitudinal and Vertical Separation

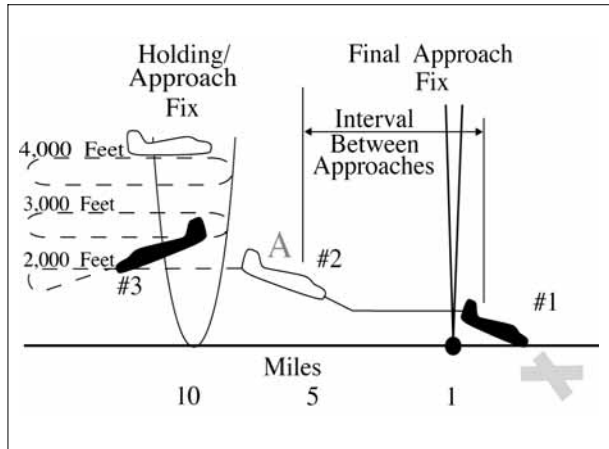

NOTE-

FIG 6-7-2 depicts the application of timed approach procedures using a holding/approach fix on a bearing of an NDB and applying a combination of longitudinal and vertical separation. The #3 aircraft has been instructed to descend to 2,000 after the #2 aircraft has reported departing the holding/approach fix inbound and leaving 2,000 at point A. The #2 aircraft has departed the holding/approach fix inbound at the designated time, maintaining 2,000 until cleared for approach at point A. The #1 aircraft has been sighted, enabling the controller to issue approach clearance to the #2 aircraft at point A.

c. Release the aircraft to the tower before it reaches the final approach fix.

6-7-3. SEQUENCE INTERRUPTION

Interrupt the established timed approach sequence if necessary to allow an aircraft to execute a different type of approach.

6-7-4. LEVEL FLIGHT RESTRICTION

If the weather report indicates an aircraft will be in IFR conditions over the final approach fix (nonprecision approach) or the outer marker or the fix used in lieu of the outer marker (precision approach) when para 6-7-2, Approach Sequence, subpara b is

applied, clear the second aircraft for an approach early enough to allow at least 1 minute of level flight before crossing the final approach fix/outer marker or the fix used in lieu of the outer marker.

6-7-5. INTERVAL MINIMA

Use a 2-minute or a 5-mile radar interval (except for a small aircraft behind a heavy aircraft: use a 3-minute or a 6-mile radar interval) as the minimum between successive approaches and increase the interval, as necessary, taking into account the:

NOTE-

Increased separation is required for small aircraft behind heavy aircraft because of the possible effects of wake turbulence.

REFERENCE-

FAAO 7110.65, Approach Separation Responsibility, Para 5-9-5

FAAO 7110.65, Application, Para 6-7-1

FAAO 7110.65, Approach Sequence, Para 6-7-2

- Relative speeds of the aircraft concerned.
- Existing weather conditions.
- Distance between the approach fix and the airport.
- Type of approach being made.

6-7-6. TIME CHECK

Issue a time check to an aircraft before specifying a time to leave the approach fix inbound unless the aircraft is vectored to the final approach course.

6-7-7. MISSED APPROACHES

a. If weather conditions are such that an aircraft will likely miss an approach, issue an alternative missed approach procedure to the next aircraft.

b. If an aircraft misses an approach, allow the next aircraft to continue the approach if it has been assigned an alternative missed approach procedure. Retain radar control or hold any remaining aircraft at assigned altitudes until traffic conditions permit the issuance of approach clearances.

c. When para 6-7-2, Approach Sequence, subpara b is applied and the first aircraft misses an approach, retain radar control or clear the second aircraft to maintain the last assigned altitude (minimum holding altitude) and return to the holding/approach fix to hold until traffic conditions permit the issuance of approach clearances.

Chapter 7. Visual

Section 1. General

7-1-1. CLASS A AIRSPACE RESTRICTIONS

Do not apply visual separation or issue VFR or “VFR-on-top” clearances in Class A airspace.

7-1-2. VFR CONDITIONS

a. You may clear aircraft to maintain “VFR conditions” if one of the following conditions exists:

1. The pilot of an aircraft on an IFR flight plan requests a VFR climb/descent.

2. **TERMINAL.** The clearance will result in noise abatement benefits where part of the IFR departure route does not conform to an FAA-approved noise abatement route or altitude.

PHRASEOLOGY-
MAINTAIN VFR CONDITIONS.

MAINTAIN VFR CONDITIONS UNTIL (time or fix).

MAINTAIN VFR CONDITIONS ABOVE/BELOW (altitude).

CLIMB/DESCEND VFR,

and if required,

BETWEEN (altitude) AND (altitude)

or

ABOVE/BELOW (altitude).

b. When, in your judgment, there is reason to believe that flight in VFR conditions may become impractical, issue an alternative clearance which will ensure separation from all other aircraft for which you have separation responsibility.

PHRASEOLOGY-
IF UNABLE, (alternative procedure), AND ADVISE.

7-1-3. APPROACH CONTROL SERVICE FOR VFR ARRIVING AIRCRAFT

Issue the following where procedures have been established for arriving VFR aircraft to contact approach control for landing information:

a. Wind, runway, and altimeter setting at the airport of intended landing. This information may be omitted if contained in the ATIS broadcast and the pilot states the appropriate ATIS code or if the pilot uses the phrase, “have numbers.”

NOTE-

Pilot use of “have numbers” does not indicate receipt of the ATIS broadcast.

b. Traffic information on a workload permitting basis.

c. Time or place at which the aircraft is to contact the tower on local control frequency for further landing information.

d. An aircraft may be instructed to contact approach control for landing and traffic information upon initial contact with the tower.

REFERENCE-

FAAO 7110.65, Application, Para 7-6-1

FAAO 7110.65, Service Availability, Para 7-6-2

7-1-4. VISUAL HOLDING OF VFR AIRCRAFT

TERMINAL

When it becomes necessary to hold VFR aircraft at visual holding fixes, take the following actions:

a. Clear aircraft to hold at selected, prominent geographical fixes which can be easily recognized from the air, preferably those depicted on sectional charts.

NOTE-

At some locations, VFR checkpoints are depicted on Sectional Aeronautical and Terminal Area Charts. In selecting geographical fixes, depicted VFR checkpoints are preferred unless the pilot exhibits a familiarity with the local area.

REFERENCE-

FAAO 7110.65, Visual Holding Points, Para 4-6-5

b. Issue traffic information to aircraft cleared to hold at the same fix.

PHRASEOLOGY-

HOLD AT (location) UNTIL (time or other condition),

TRAFFIC (description) HOLDING AT (fix, altitude if known),

or

PROCEEDING TO (fix) FROM (direction or fix).

REFERENCE-

FAAO 7110.65, Holding, Para 7-6-5

Section 2. Visual Separation

7-2-1. VISUAL SEPARATION

Aircraft may be separated by visual means, as provided in this paragraph, when other approved separation is assured before and after the application of visual separation. To ensure that other separation will exist, consider aircraft performance, wake turbulence, closure rate, routes of flight, and known weather conditions. Reported weather conditions must allow the aircraft to remain within sight until other separation exists. Do not apply visual separation between successive departures when departure routes and/or aircraft performance preclude maintaining separation.

REFERENCE-

FAAO 7110.65, *Wake Turbulence Cautionary Advisories, Para 2-1-20*

FAAO 7110.65, *Traffic Advisories, Para 2-1-21*

FAAO 7110.65, *Use of Tower Radar Displays, Para 3-1-9*

FAAO 7110.65, *Approach Separation Responsibility, Para 5-9-5*

FAAO 7110.65, *Visual Approach, Para 7-4-1*

FAAO 7110.65, *Vectors for Visual Approach, Para 7-4-2*

FAAO 7110.65, *Approaches to Multiple Runways, Para 7-4-4*

P/CG Term- Visual Approach.

P/CG Term- Visual Separation.

a. TERMINAL. Visual separation may be applied between aircraft under the control of the same facility within the terminal area up to but not including FL 180, provided:

1. Communication is maintained with at least one of the aircraft involved or the capability to communicate immediately as prescribed in para 3-9-3, Departure Control Instructions, subpara a2 is available, and:

2. The aircraft are visually observed by the tower and visual separation is maintained between the aircraft by the tower. The tower shall not provide visual separation between aircraft when wake turbulence separation is required or when the lead aircraft is a B757.

3. A pilot sees another aircraft and is instructed to maintain visual separation from the aircraft as follows:

(a) Tell the pilot about the other aircraft including position, direction and, unless it is obvious, the other aircraft's intention.

(b) Obtain acknowledgment from the pilot that the other aircraft is in sight.

(c) Instruct the pilot to maintain visual separation from that aircraft.

(d) Advise the pilot if the radar targets appear likely to converge.

NOTE-

Issue this advisory in conjunction with the instruction to maintain visual separation, or thereafter if the controller subsequently becomes aware that the targets are merging.

(e) If the aircraft are on converging courses, inform the other aircraft of the traffic and that visual separation is being applied.

(f) If the pilot advises he/she has the traffic in sight and will maintain visual separation from it (the pilot must use that entire phrase), the controller need only "approve" the operation instead of restating the instructions.

PHRASEOLOGY-

TRAFFIC, (clock position and distance), (direction)-BOUND, (type of aircraft), (intentions and other relevant information).

If applicable,

ON CONVERGING COURSE.

DO YOU HAVE IT IN SIGHT?

If the answer is in the affirmative,

MAINTAIN VISUAL SEPARATION.

If the pilot advises he/she has the traffic in sight and will maintain visual separation from it (pilot must use that entire phrase):

APPROVED.

If aircraft are on converging courses, advise the other aircraft:

TRAFFIC, (clock position and distance), (direction)-BOUND, (type of aircraft), HAS YOU IN SIGHT AND WILL MAINTAIN VISUAL SEPARATION.

b. EN ROUTE. Visual separation may be used up to but not including FL 180 when the following conditions are met:

1. Direct communication is maintained with one of the aircraft involved and there is an ability to communicate with the other.

2. A pilot sees another aircraft and is instructed to maintain visual separation from it as follows:

(a) Tell the pilot about the other aircraft including position, direction and unless it is obvious, the other aircraft's intentions.

(b) Obtain acknowledgment from the pilot that the other aircraft is in sight.

(c) Instruct the pilot to maintain visual separation from that aircraft.

(d) Advise the pilot if the radar targets appear likely to converge.

(e) If the aircraft are on converging courses, inform the other aircraft of the traffic and that visual separation is being applied.

(f) Advise the pilots if either aircraft is a heavy.

(g) Traffic advisories and wake turbulence cautionary advisories shall be issued in accordance with para 2-1-20, Wake Turbulence Cautionary Advisories, and para 2-1-21, Traffic Advisories.

(h) If the pilot advises he/she has the traffic in sight and will maintain visual separation from it (the pilot must use that entire phrase), the controller need only "approve" the operation instead of restating the instructions.

PHRASEOLOGY-

TRAFFIC, (clock position and distance), (direction)-BOUND, (type of aircraft), (intentions and other relevant information).

If applicable,

ON CONVERGING COURSE.

DO YOU HAVE IT IN SIGHT?

If the answer is in the affirmative,

MAINTAIN VISUAL SEPARATION.

If the pilot advises he/she has the traffic in sight and will maintain visual separation from it (pilot must use that entire phrase):

(Call Sign) APPROVED.

If aircraft are on converging courses, advise the other aircraft:

TRAFFIC, (clock position and distance), (direction)-BOUND, (type of aircraft), HAS YOU IN SIGHT AND WILL MAINTAIN VISUAL SEPARATION.

REFERENCE-

FAAO 7110.65, Visual Approach, Para 7-4-1

FAAO 7110.65, Vectors for Visual Approach, Para 7-4-2

c. Nonapproach control towers may be authorized to provide visual separation between aircraft within surface areas or designated areas provided other separation is assured before and after the application of visual separation. This may be applied by the nonapproach control tower providing the separation or by a pilot visually observing another aircraft and being instructed to maintain visual separation with that aircraft.

PHRASEOLOGY-

VISUAL SEPARATION APPROVED BETWEEN (identification) AND (identification),

and for departing aircraft,

(departing/succeeding aircraft) RELEASED YOUR DISCRETION.

NOTE-

Separation of IFR aircraft before and after application of visual separation is an IFR control function (Approach/Departure/En Route). A nonapproach control tower by accepting authorization for visual separation becomes responsible for ensuring that separation. Separation requirements also apply to VFR aircraft when IFR, Class B, Class C or TRSA separation is prescribed.

REFERENCE-

FAAO 7110.65, Practice Approaches, Para 4-8-1.

FAAO 7110.65, Application, Para 5-6-1

FAAO 7110.65, Vectors for Visual Approach, Para 7-4-2

FAAO 7110.65, Application, Para 7-6-1

FAAO 7110.65, Application, Para 7-7-1

FAAO 7110.65, Issuance of EFC, Para 7-7-2

FAAO 7110.65, Separation, Para 7-7-3

FAAO 7110.65, Helicopter Traffic, Para 7-7-4

FAAO 7110.65, Altitude Assignments, Para 7-7-5

FAAO 7110.65, Approach Interval, Para 7-7-6

FAAO 7110.65, TRSA Departure Information, Para 7-7-7

FAAO 7110.65, Class C Services, Para 7-8-2

FAAO 7110.65, Separation, Para 7-8-3

FAAO 7110.65, Establishing Two-Way Communications, Para 7-8-4

FAAO 7110.65, Altitude Assignments, Para 7-8-5

FAAO 7110.65, Exceptions, Para 7-8-6

FAAO 7110.65, Application, Para 7-9-1

FAAO 7110.65, Methods, Para 7-9-3

FAAO 7110.65, Separation, Para 7-9-4

FAAO 7110.65, Helicopter Traffic, Para 7-9-6

FAAO 7110.65, Altitude Assignments, Para 7-9-7

Section 3. VFR-on-top

7-3-1. VFR-ON-TOP

a. You may clear an aircraft to maintain “VFR-on-top” if the pilot of an aircraft on an IFR flight plan requests the clearance.

PHRASEOLOGY-
MAINTAIN VFR-ON-TOP.

NOTE-

1. When an aircraft has been cleared to maintain “VFR-on-top,” the pilot is responsible to fly at an appropriate VFR altitude, comply with VFR visibility and distance from cloud criteria, and to be vigilant so as to see and avoid other aircraft. The pilot is also responsible to comply with instrument flight rules applicable to the flight (e.g., adherence to ATC clearances).

2. Although standard IFR separation is not applied, controllers shall continue to provide traffic advisories and safety alerts, and apply merging target procedures to aircraft operating VFR-on-top.

REFERENCE-

FAAO 7110.65, Safety Alert, Para 2-1-6
FAAO 7110.65, Traffic Advisories, Para 2-1-21
FAAO 7110.65, Merging Target Procedures, Para 5-1-8
FAAO 7110.65, Class A Airspace Restrictions, Para 7-1-1
AIM, VFR-on-top, Para 5-5-13.
14 CFR Section 91.157, Special VFR Weather Minimums.
14 CFR Section 91.159, VFR Cruising Altitude or Flight Level.

b. You may clear an aircraft to climb through clouds, smoke, haze, or other meteorological formations and then to maintain “VFR-on-top” if the following conditions are met:

1. The pilot requests the clearance.
2. You inform the pilot of the reported height of the tops of the meteorological formation, or
3. You inform the pilot that no top report is available.
4. When necessary, you ensure separation from all other traffic for which you have separation responsibility by issuing an alternative clearance.
5. When an aircraft is climbing to and reports reaching “VFR-on-top,” reclear the aircraft to maintain “VFR-on-top.”

PHRASEOLOGY-

CLIMB TO AND REPORT REACHING VFR-ON-TOP,

and

TOPS REPORTED (altitude),

or

NO TOPS REPORTS.

IF NOT ON TOP AT (altitude), MAINTAIN (altitude), AND ADVISE.

MAINTAIN VFR-ON-TOP.

c. Do not clear an aircraft to maintain “VFR-on-top” between sunset and sunrise to separate holding aircraft from each other or from en route aircraft unless restrictions are applied to ensure the appropriate IFR vertical separation.

PHRASEOLOGY-

MAINTAIN VFR-ON-TOP AT OR ABOVE/BELOW/ BETWEEN (altitudes).

EXAMPLE-

“Maintain VFR-on-top at or above one three thousand five hundred.”

“Maintain VFR-on-top at or below one two thousand five hundred.”

“Maintain VFR-on-top at or between six thousand and one zero thousand.”

d. When, in your judgment, there is reason to believe that flight in VFR conditions may become impractical, issue an alternative clearance which will ensure separation from all other aircraft for which you have separation responsibility.

PHRASEOLOGY-

IF UNABLE, (alternative procedure), AND ADVISE.

REFERENCE-

FAAO 7110.65, VFR-on-top, Para 9-4-3

7-3-2. ALTITUDE FOR DIRECTION OF FLIGHT

Inform an aircraft maintaining “VFR-on-top” when a report indicates the pilot is not complying with 14 CFR Section 91.159(a).

NOTE-

As required by 14 CFR Section 91.159(a), the appropriate VFR altitudes for aircraft (not in a holding pattern of 2 minutes or less, or turning) operating more than 3,000 feet above the surface to and including 18,000 feet MSL:

Magnetic courses 0-179- odd cardinal altitudes plus 500 feet; e.g., 3,500, 5,500.

Magnetic courses 180-359- even cardinal altitudes plus 500 feet; e.g., 4,500, 8,500.

PHRASEOLOGY-

VFR-ON-TOP CRUISING LEVELS FOR YOUR DIRECTION OF FLIGHT ARE:

more than 3,000 feet above the surface to FL 180:

ODD/EVEN ALTITUDES/FLIGHT LEVELS PLUS FIVE HUNDRED FEET.

Section 4. Approaches

7-4-1. VISUAL APPROACH

A visual approach is an ATC authorization for an aircraft on an IFR flight plan to proceed visually to the airport of intended landing; it is not an instrument approach procedure. Also, there is no missed approach segment. An aircraft unable to complete a visual approach shall be handled as any go-around and appropriate separation must be provided.

REFERENCE-

FAAO 7110.65, *Wake Turbulence Cautionary Advisories, Para 2-1-20*

FAAO 7110.65, *Forwarding Approach Information by Nonapproach Control Facilities, Para 3-10-2*

FAAO 7110.65, *Visual Separation, Para 7-2-1*

FAAO 7110.65, *Approaches to Multiple Runways, Para 7-4-4*

7-4-2. VECTORS FOR VISUAL APPROACH

A vector for a visual approach may be initiated if the reported ceiling at the airport of intended landing is at least 500 feet above the MVA/MIA and the visibility is 3 miles or greater. At airports without weather reporting service there must be reasonable assurance (e.g. area weather reports, PIREPs, etc.) that descent and flight to the airport can be made visually, and the pilot must be informed that weather information is not available.

PHRASEOLOGY-

(Ident) FLY HEADING OR TURN RIGHT/LEFT HEADING (degrees) VECTOR FOR VISUAL APPROACH TO (airport name).

(If appropriate)

WEATHER NOT AVAILABLE.

NOTE-

At airports where weather information is not available, a pilot request for a visual approach indicates that descent and flight to the airport can be made visually and clear of clouds.

REFERENCE-

FAAO 7110.65, *Vectors to Final Approach Course, Para 5-9-1*

FAAO 7110.65, *Visual Separation, Para 7-2-1*

FAAO 7110.65, *Clearance for Visual Approach, Para 7-4-3*

FAAO 7110.65, *Approaches to Multiple Runways, Para 7-4-4*

FAAO 7110.65, *Sequencing, Para 7-6-7*

FAAO 7110.65, *Separation, Para 7-7-3*

7-4-3. CLEARANCE FOR VISUAL APPROACH

ARTCCs and approach controls may clear aircraft for visual approaches using the following procedures:

NOTE-

Towers may exercise this authority when authorized by a LOA with the facility that provides the IFR service, or by a facility directive at collocated facilities.

a. Controllers may initiate, or pilots may request, a visual approach even when an aircraft is being vectored for an instrument approach and the pilot subsequently reports:

1. The airport or the runway in sight at airports with operating control towers.

2. The airport in sight at airports without a control tower.

b. Resolve potential conflicts with all other aircraft, advise an overtaking aircraft of the distance to the preceding aircraft and speed difference, and ensure that weather conditions at the airport are VFR or that the pilot has been informed that weather is not available for the destination airport. Upon pilot request, advise the pilot of the frequency to receive weather information where AWOS/ASOS is available.

PHRASEOLOGY-

(Ident) (instructions) CLEARED VISUAL APPROACH RUNWAY (number);

or

(ident) (instructions) CLEARED VISUAL APPROACH TO (airport name)

(and if appropriate)

WEATHER NOT AVAILABLE OR VERIFY THAT YOU HAVE THE (airport) WEATHER.

REFERENCE-

FAAO 7110.65, *Visual Separation, Para 7-2-1*

c. Clear an aircraft for a visual approach when:

1. The aircraft is number one in the approach sequence, or

2. The aircraft is to follow a preceding aircraft and the pilot reports the preceding aircraft in sight and is instructed to follow it, or

NOTE-

The pilot need not report the airport/runway in sight.

3. The pilot reports the airport or runway in sight but not the preceding aircraft. Radar separation must be maintained until visual separation is provided.

d. All aircraft following a heavy jet/B757 must be informed of the airplane manufacturer and model.

EXAMPLE-

“Cessna Three Four Juliet, following a Boeing 757, 12 o’clock, six miles.”

e. Inform the tower of the aircraft’s position prior to communications transfer at controlled airports. ARTS/STARS functions may be used provided a facility directive or LOA specifies control and communication transfer points.

f. In addition to the requirements of para 7-4-2, Vectors for Visual Approach, and subparagraphs a, b, c, d, and e, ensure that the location of the destination airport is provided when the pilot is asked to report the destination airport in sight.

g. In those instances where airports are located in close proximity, also provide the location of the airport that may cause the confusion.

EXAMPLE-

“Cessna Five Six November, Cleveland Burke Lakefront Airport is at 12 o’clock, 5 miles. Cleveland Hopkins Airport is at 1 o’clock 12 miles. Report Cleveland Hopkins in sight.”

REFERENCE-

FAAO 7110.65, Approaches to Multiple Runways, Para 7-4-4

7-4-4. APPROACHES TO MULTIPLE RUNWAYS

a. All aircraft must be informed that approaches are being conducted to parallel/intersecting/converging runways. This may be accomplished through use of the ATIS.

b. When conducting visual approaches to multiple runways ensure the following:

1. Do not permit the respective aircrafts’ primary radar returns to merge unless visual separation is being applied.

2. When the aircraft flight paths intersect, ensure standard separation is maintained until visual separation is provided.

c. In addition to the requirements in para 7-2-1, Visual Separation, para 7-4-1, Visual Approach, para 7-4-2, Vectors for Visual Approach, and

para 7-4-3, Clearance for Visual Approach, the following conditions apply to visual approaches being conducted simultaneously to parallel, intersecting, and converging runways, as appropriate:

1. Parallel runways separated by less than 2,500 feet. Unless standard separation is provided by ATC, an aircraft must report sighting a preceding aircraft making an approach (instrument or visual) to the adjacent parallel runway. When an aircraft reports another aircraft in sight on the adjacent final approach course and visual separation is applied, controllers must advise the succeeding aircraft to maintain visual separation. However, do not permit a heavy/B757 aircraft to overtake another aircraft. Do not permit a large aircraft to overtake a small aircraft.

2. Parallel runways separated by at least 2,500 feet, but less than 4,300 feet.

(a) Standard separation is provided until the aircraft are established on a heading which will intercept the extended centerline of the runway at an angle not greater than 30 degrees, and each aircraft has been issued and the pilot has acknowledged receipt of the visual approach clearance.

NOTE-

The intent of the 30 degree intercept angle is to reduce the potential for overshoots of the final, and preclude side-by-side operations with one or both aircraft in a “belly-up” configuration during the turn. Aircraft performance, speed, and the number of degrees of the turn to the final are factors to be considered by the controller when vectoring aircraft to parallel runways.

(b) Visual approaches may be conducted to one runway while visual or instrument approaches are conducted simultaneously to the other runway, provided the conditions of subpara (a) are met.

(c) Provided aircraft flight paths do not intersect, and when the provisions of subparagraphs (a) and (b) are met, it is not necessary to apply any other type of separation with aircraft on the adjacent final approach course.

3. Parallel runways separated by 4,300 feet or more.

(a) When aircraft flight paths do not intersect, visual approaches may be conducted simultaneously, provided standard separation is maintained until one of the aircraft has been issued and the pilot has acknowledged receipt of the visual approach clearance.

(b) Visual approaches may be conducted to one runway while visual or instrument approaches are conducted simultaneously to the other runway, provided the conditions of subpara (a) are met.

(c) Provided the aircraft flight paths do not intersect, when the provisions of subparas (a) and (b) are met, it is not necessary to apply any other type of separation with aircraft on the adjacent final approach course.

4. Intersecting and converging runways. Visual approaches may be conducted simultaneously with visual or instrument approaches to another runway, provided:

(a) Standard separation is maintained until the aircraft conducting the visual approach has been issued and the pilot has acknowledged receipt of the visual approach clearance.

(b) When aircraft flight paths intersect, radar separation must be maintained until visual separation is provided.

NOTE-

Although simultaneous approaches may be conducted to intersecting runways, staggered approaches may be necessary to meet the airport separation requirements specified in para 3-10-4 Intersecting Runway Separation.

REFERENCE-

*FAAO 7110.79, Charted Visual Flight Procedures.
FAAO 7110.65, Charted Visual Flight Procedures (CVFP). USA/USN Not Applicable, Para 7-4-5
FAAO 7110.65, Separation, Para 7-7-3*

7-4-5. CHARTED VISUAL FLIGHT PROCEDURES (CVFP). USA/USN NOT APPLICABLE

Clear an aircraft for a CVFP only when the following conditions are met:

- a. There is an operating control tower.
- b. The published name of the CVFP and the landing runway are specified in the approach clearance, the reported ceiling at the airport of intended landing is at least 500 feet above the MVA/MIA, and the visibility is 3 miles or more, unless higher minimums are published for the particular CVFP.
- c. When using parallel or intersecting/converging runways, the criteria specified in para 7-4-4, Approaches to Multiple Runways, are applied.

d. An aircraft not following another aircraft on the approach reports sighting a charted visual landmark, or reports sighting a preceding aircraft landing on the same runway and has been instructed to follow that aircraft.

PHRASEOLOGY-

(Ident) CLEARED (name of CVFP) APPROACH.

7-4-6. CONTACT APPROACH

Clear an aircraft for a contact approach only if the following conditions are met:

- a. The pilot has requested it.

NOTE-

When executing a contact approach, the pilot is responsible for maintaining the required flight visibility, cloud clearance, and terrain/obstruction clearance. Unless otherwise restricted, the pilot may find it necessary to descend, climb, and/or fly a circuitous route to the airport to maintain cloud clearance and/or terrain/obstruction clearance. It is not in any way intended that controllers will initiate or suggest a contact approach to a pilot.

b. The reported ground visibility is at least 1 statute mile.

c. A standard or special instrument approach procedure has been published and is functioning for the airport of intended landing.

d. Approved separation is applied between aircraft so cleared and other IFR or SVFR aircraft. When applying vertical separation, do not assign a fixed altitude but clear the aircraft at or below an altitude which is at least 1,000 feet below any IFR traffic but not below the minimum safe altitude prescribed in 14 CFR Section 91.119.

NOTE-

14 CFR Section 91.119 specifies the minimum safe altitude to be flown:

- (a) Anywhere.
- (b) Over congested areas.
- (c) Other than congested areas. *To provide for an emergency landing in the event of power failure and without undue hazard to persons or property on the surface.*
- (d) Helicopters. *May be operated at less than the minimums prescribed in paras (b) and (c) above if the operation is conducted without hazard to persons or property on the surface.*

e. An alternative clearance is issued when weather conditions are such that a contact approach may be impracticable.

***PHRASEOLOGY–
CLEARED CONTACT APPROACH,***

*And if required,
AT OR BELOW (altitude) (routing).*

*IF NOT POSSIBLE, (alternative procedures), AND
ADVISE.*

Section 5. Special VFR (SVFR)

7-5-1. AUTHORIZATION

a. SVFR operations in weather conditions less than basic VFR minima are authorized:

REFERENCE-

FAAO 7110.65, Operational Priority, Para 2-1-4

1. At any location not prohibited by 14 CFR Part 91, Appendix D or when an exemption to 14 CFR Part 91 has been granted and an associated LOA established. 14 CFR Part 91 does not prohibit SVFR helicopter operations.

2. Only within the lateral boundaries of Class B, Class C, Class D, or Class E surface areas, below 10,000 feet MSL.

3. Only when requested by the pilot.

4. On the basis of weather conditions reported at the airport of intended landing/departure.

REFERENCE-

FAAO 7110.65, Climb to VFR, Para 7-5-6

FAAO 7110.65, Ground Visibility Below One Mile, Para 7-5-7

5. When weather conditions are not reported at the airport of intended landing/departure and the pilot advises that VFR cannot be maintained and requests SVFR.

PHRASEOLOGY-

CLEARED TO ENTER/OUT OF/THROUGH, (name) SURFACE AREA

and if required,

(direction) OF (name) AIRPORT (specified routing), and

MAINTAIN SPECIAL V-F-R CONDITIONS,

and if required,

AT OR BELOW (altitude below 10,000 feet MSL)

or as applicable under an exemption from 14 CFR Part 91,

CLEARED FOR (coded arrival or departure procedure) ARRIVAL/DEPARTURE, (additional instructions as required).

REFERENCE-

FAAO 7110.65, Airspace Classes, 2-4-22

b. SVFR operations may be authorized for aircraft operating in or transiting a Class B, Class C, Class D, or Class E surface area when the primary airport is reporting VFR but the pilot advises that basic VFR cannot be maintained.

NOTE-

The basic requirements for issuance of a SVFR clearance in subpara a apply with the obvious exception that weather conditions at the controlling airport are not required to be less than basic VFR minima.

7-5-2. PRIORITY

a. SVFR flights may be approved only if arriving and departing IFR aircraft are not delayed.

EXAMPLE-

1. *A SVFR aircraft has been cleared to enter a Class B, Class C, Class D, or Class E surface area and subsequently an IFR aircraft is ready to depart or is in position to begin an approach. Less overall delay might accrue to the IFR aircraft if the SVFR aircraft is allowed to proceed to the airport and land, rather than leave, a Class B, Class C, Class D, or Class E surface area or be repositioned to provide IFR priority.*

2. *A SVFR aircraft is number one for takeoff and located in such a position that the number two aircraft, an IFR flight, cannot taxi past to gain access to the runway. Less overall delay might accrue to the IFR aircraft by releasing the SVFR departure rather than by having the aircraft taxi down the runway to a turnoff point so the IFR aircraft could be released first.*

NOTE-

The priority afforded IFR aircraft over SVFR aircraft is not intended to be so rigidly applied that inefficient use of airspace results. The controller has the prerogative of permitting completion of a SVFR operation already in progress when an IFR aircraft becomes a factor if better overall efficiency will result.

b. Inform an aircraft of the anticipated delay when a SVFR clearance cannot be granted because of IFR traffic. Do not issue an EFC or expected departure time.

PHRASEOLOGY-

EXPECT (number) MINUTES DELAY, (additional instructions as necessary).

REFERENCE-

FAAO 7110.65, Operational Priority, Para 2-1-4

FAAO 7110.65, Application, Para 5-6-1

7-5-3. SEPARATION

a. Apply approved separation between:

1. SVFR aircraft.
2. SVFR aircraft and IFR aircraft.

NOTE-

Approved separation between SVFR fixed-wing aircraft, and between SVFR fixed-wing aircraft and IFR fixed-wing aircraft, is prescribed in Chapter 6 and Chapter 7, para 7-5-4 Altitude Assignment. Radar vectors are authorized as prescribed in para 5-6-1 Application, subpara f.

b. Alternate SVFR helicopter separation minima may be established when warranted by the volume and/or complexity of local helicopter operations. Alternate SVFR helicopter separation minima shall be established with an LOA with the helicopter operator which shall specify, as a minimum, that SVFR helicopters are to maintain visual reference to the surface and adhere to the following aircraft separation minima:

1. Between a SVFR helicopter and an arriving or departing IFR aircraft:

(a) $\frac{1}{2}$ mile. If the IFR aircraft is less than 1 mile from the landing airport.

(b) 1 mile. If the IFR aircraft is 1 mile or more from the airport.

2. 1 mile between SVFR helicopters. This separation may be reduced to 200 feet if:

(a) Both helicopters are departing simultaneously on courses that diverge by at least 30 degrees and:

(1) The tower can determine this separation by reference to surface markings; or

(2) One of the departing helicopters is instructed to remain at least 200 feet from the other.

NOTE-

Radar vectors are authorized as prescribed in para 5-6-1 Application.

REFERENCE-

FAAO 7110.65, Operational Priority, Para 2-1-4

7-5-4. ALTITUDE ASSIGNMENT

Do not assign a fixed altitude when applying vertical separation, but clear the SVFR aircraft at or below an altitude which is at least 500 feet below any conflicting IFR traffic but not below the MSA prescribed in 14 CFR Section 91.119.

PHRASEOLOGY-

MAINTAIN SPECIAL V-F-R CONDITIONS AT OR BELOW (altitude).

NOTE-

1. *SVFR aircraft are not assigned fixed altitudes to maintain because of the clearance from clouds requirement.*

2. *The MSAs are:*

(a) *Over congested areas, an altitude at least 1,000 feet above the highest obstacle, and*

(b) *Over other than congested areas, an altitude at least 500 feet above the surface.*

(c) *Helicopters may be operated at less than the minimum altitudes prescribed in (a) and (b) above.*

REFERENCE-

FAAO 7110.65, Operational Priority, Para 2-1-4

FAAO 7110.65, Application, Para 5-6-1

14 CFR Section 91.119, Minimum Safe Altitudes: General.

7-5-5. LOCAL OPERATIONS

a. Authorize local SVFR operations for a specified period (series of landings and takeoffs, etc.) upon request if the aircraft can be recalled when traffic or weather conditions require. Where warranted, LOAs may be consummated.

PHRASEOLOGY-

LOCAL SPECIAL V-F-R OPERATIONS IN THE IMMEDIATE VICINITY OF (name) AIRPORT ARE AUTHORIZED UNTIL (time). MAINTAIN SPECIAL V-F-R-CONDITIONS.

REFERENCE-

FAAO 7210.3, Appropriate Subjects, Para 4-3-2.

b. Control facilities may also authorize an FSS to transmit SVFR clearances so that only one aircraft at a time operates in the Class B, Class C, Class D, or Class E surface areas unless pilots agree that they will maintain visual separation with other aircraft operating in the Class B, Class C, Class D, or Class E surface areas. Such authorization concerning visual separation by pilots shall be contained in a LOA between the control facility and the FSS.

REFERENCE-

FAAO 7210.3, Developing LOA, Para 4-3-3.

FAAO 7110.65, Operational Priority, Para 2-1-4

7-5-6. CLIMB TO VFR

Authorize an aircraft to climb to VFR upon request if the only weather limitation is restricted visibility.

PHRASEOLOGY-

CLIMB TO V-F-R WITHIN (name) SURFACE AREA/ WITHIN (a specified distance) MILES FROM (airport name) AIRPORT, MAINTAIN SPECIAL V-F-R CONDITIONS UNTIL REACHING V-F-R.

REFERENCE-

FAAO 7110.65, Operational Priority, Para 2-1-4

FAAO 7110.65, Airspace Classes, Para 2-4-22

FAAO 7110.65, Authorization, Para 7-5-1

7-5-7. GROUND VISIBILITY BELOW ONE MILE

14 CFR Part 91 does not prohibit helicopter SVFR flight when the visibility is less than 1 mile. Treat requests for SVFR fixed wing operations as follows when the ground visibility is officially reported at an airport as less than 1 mile:

a. Inform departing aircraft that ground visibility is less than 1 mile and that a clearance cannot be issued.

b. Inform arriving aircraft, operating outside of a Class B, Class C, Class D, or Class E surface area, that ground visibility is less than 1 mile and that, unless an emergency exists, a clearance cannot be issued.

c. Inform arriving aircraft, operating VFR/SVFR within a Class B, Class C, Class D, or Class E surface area, that ground visibility is less than 1 mile and request the pilot to advise intentions.

PHRASEOLOGY-

(Name of airport) VISIBILITY LESS THAN ONE MILE. ADVISE INTENTIONS.

NOTE-

Clear an aircraft to land at an airport with an operating control tower, traffic permitting, if the pilot reports the airport in sight. The pilot is responsible to continue to the airport or exit the surface area. 14 CFR Section 91.157 prohibits VFR aircraft (other than helicopters) from landing at any airport within a surface area when ground visibility is less than 1 mile. A pilot could inadvertently encounter conditions that are below SVFR minimums after entering a surface area due to rapidly changing weather. The pilot is best suited to determine the action to be taken since pilots operating under SVFR between sunrise and sunset are not required to be instrument rated, and the possibility exists that flight visibility may not be the same as ground visibility. 14 CFR Section 91.3 authorizes a pilot

encountering an inflight emergency requiring immediate action to deviate from any rule of 14 CFR Part 91 to the extent required to meet that emergency. Flight into adverse weather conditions may require the pilot to execute the emergency authority granted in 14 CFR Section 91.3 and continue inbound to land.

d. Authorize scheduled air carrier aircraft in the U.S. to conduct operations if ground visibility is not less than $\frac{1}{2}$ statute mile.

NOTE-

14 CFR Part 121 permits landing or takeoff by domestic scheduled air carriers where a local surface restriction to visibility is not less than $\frac{1}{2}$ statute mile, provided all turns after takeoff or before landing and all flights beyond 1 statute mile from the airport boundary can be accomplished above or outside the area so restricted. The pilot is solely responsible for determining if the nature of the visibility restriction will permit compliance with the provisions of 14 CFR Part 121.

e. Clear an aircraft to fly through the Class B, Class C, Class D, or Class E surface area if the aircraft reports flight visibility is at least 1 statute mile.

REFERENCE-

FAAO 7110.65, Operational Priority, Para 2-1-4

FAAO 7110.65, Authorization, Para 7-5-1

7-5-8. FLIGHT VISIBILITY BELOW ONE MILE

Treat requests for SVFR fixed-wing operations as follows when weather conditions are not reported at an airport and the pilot advises the flight visibility is less than 1 mile:

NOTE-

14 CFR Part 91 prescribes the visibility for basic VFR and SVFR operations as the official reported ground visibility at airports where provided and landing or takeoff "flight visibility" where there is no official reported ground visibility.

a. Inform departing aircraft that a clearance cannot be issued.

b. Inform arriving aircraft operating outside of a Class B, Class C, Class D or Class E surface area that a clearance cannot be issued unless an emergency exists.

c. Request the intentions of an arriving aircraft operating within a Class B, Class C, Class D, or Class E surface area.

NOTE-

Clear an aircraft to land at an airport with an operating control tower, traffic permitting, if the pilot reports the airport in sight. The pilot is responsible to continue to the airport or exit the surface area. 14 CFR Section 91.157 prohibits VFR aircraft (other than helicopters) from landing at any airport within a surface area when flight visibility is less than 1 mile. A pilot could inadvertently encounter conditions that are below SVFR minimums after entering a surface area due to rapidly changing weather. The pilot is best suited to determine the action to be taken since pilots operating under SVFR between sunrise and

sunset are not required to be instrument rated, and the possibility exists that flight visibility may not be the same as ground visibility. 14 CFR Section 91.3 authorizes a pilot encountering an inflight emergency requiring immediate action to deviate from any rule of 14 CFR Part 91 to the extent required to meet that emergency. Flight into adverse weather conditions may require the pilot to execute the emergency authority granted in 14 CFR Section 91.3 and continue inbound to land.

REFERENCE-

FAAO 7110.65, Operational Priority, Para 2-1-4

Section 6. Basic Radar Service to VFR Aircraft– Terminal

7-6-1. APPLICATION

a. Basic radar services for VFR aircraft shall include:

1. Safety alerts.
2. Traffic advisories.
3. Limited radar vectoring when requested by the pilot.
4. Sequencing at locations where procedures have been established for this purpose and/or when covered by a LOA.

b. Apply the procedures contained in para 7-1-3, Approach Control Service for VFR Arriving Aircraft, when arriving VFR aircraft are handled by approach control and provide vectoring service in accordance with Chapter 5, Radar, Section 7, Speed Adjustment, in addition to the radar services prescribed in para 5-6-1, Application, and para 5-6-2, Methods.

REFERENCE-

FAAO 7110.65, *Surface Areas, Para 2-1-16*
FAAO 7110.65, *Application, Para 7-6-1*
FAAO 7210.3, *Chapter 11, Section 1. Terminal VFR Radar Services.*
AIM, *Terminal Radar Services for VFR Aircraft, Para 4-1-17.*

7-6-2. SERVICE AVAILABILITY

a. Inform aircraft on initial contact whenever this service cannot be provided because of radar outage and apply para 7-1-3, Approach Control Service for VFR Arriving Aircraft.

b. Provide the service, to the extent possible using an available frequency, if an aircraft desires the service but cannot communicate on the appropriate frequencies. Aircraft which do not desire radar service may be fitted into the landing sequence by the tower. Coordination of these aircraft shall be accomplished with the approach control unless a facility directive/LOA prescribes otherwise. Nonparticipating aircraft shall, to the extent possible, be given the same landing sequence they would have received had they been sequenced by radar vectors.

c. Radar sequencing to the primary airport, when local procedures have been developed, shall be provided unless the pilot states that the service is not requested. Arriving aircraft are assumed to want radar service unless the pilot states “Negative radar service,” or makes a similar comment.

7-6-3. INITIAL CONTACT

An aircraft sighted by the local controller at the time of first radio contact may be positioned in the landing sequence after coordination with approach control.

7-6-4. IDENTIFICATION

Identify the aircraft before taking action to position it in the approach sequence.

7-6-5. HOLDING

Hold VFR aircraft over the initial reporting fix or a fix near the airport when holding is required to establish an approach sequence.

REFERENCE-

FAAO 7110.65, *Visual Holding of VFR Aircraft, Para 7-1-4*

7-6-6. APPROACH SEQUENCE

Do not assign landing sequence numbers, when establishing aircraft in the approach sequence, unless this responsibility has been delegated in a LOA or facility directive.

NOTE-

The landing sequence is ordinarily established by the tower.

7-6-7. SEQUENCING

a. Establish radar contact before instructing a VFR aircraft to enter the traffic pattern at a specified point or vectoring the aircraft to a position in the approach sequence. Inform the pilot of the aircraft to follow when the integrity of the approach sequence is dependent on following a preceding aircraft. Ensure visual contact is established with the aircraft to follow and provide instruction to follow that aircraft.

PHRASEOLOGY-

FOLLOW (description) (position, if necessary).

b. Direct a VFR aircraft to a point near the airport to hold when a position is not available in the approach sequence for the runway in use. The aircraft may be vectored to another runway after coordination with the tower.

c. Apply the following procedures to a VFR aircraft being radar sequenced:

1. The provisions of para 5-5-4, Minima, subparagraph e and f.

2. When parallel runways are less than 2,500 feet apart, do not permit a heavy jet/B757 to overtake any aircraft nor a large aircraft to overtake a small aircraft established on final within the facility's area of responsibility.

7-6-8. CONTROL TRANSFER

a. Inform the tower of the aircraft's position and then instruct the pilot to contact the tower.

b. The aircraft may be instructed to contact the tower prior to the tower being advised of the aircraft's position provided:

1. The tower advises the aircraft is in sight, and
2. Space is available in the landing sequence.

c. Instruct the pilot to contact the tower at the appropriate point when the approach control ARTS/STARS track data is being displayed on the tower's BRITE/DBRITE/TDW display, the aircraft is tagged by ARTS/STARS, and a facility directive specifies change of communications and control jurisdiction points.

NOTE-

The point at which an aircraft is instructed to contact the tower is determined by prior coordination between the tower and approach control and will vary, depending on the runway in use, weather, etc. The transfer of communications ordinarily occurs at least 5 miles from the runway. The point for the transfer of communications should be a sufficient distance from the airport to permit the tower to properly sequence the aircraft, but not at a distance that could derogate the provision of radar traffic information service.

7-6-9. ABANDONED APPROACH

Instruct the aircraft to change to approach control for sequencing when an aircraft, under tower control, abandons the approach and coordination with approach control reveals no immediate space in the approach sequence.

7-6-10. VFR DEPARTURE INFORMATION

Inform departing VFR aircraft who request radar traffic advisories when to contact departure control and the frequency to use. Provide traffic advisories in accordance with para 2-1-21, Traffic Advisories, after the departure is radar identified.

NOTE-

Departing aircraft desiring traffic information are expected to request the service and to state their proposed direction of flight upon initial contact with ground control.

7-6-11. TERMINATION OF SERVICE

Basic radar services should be provided to the extent possible, workload permitting. Terminate radar service to aircraft landing at airports other than those where sequencing service is provided at a sufficient distance from the airport to permit the pilot to change to the appropriate frequency for traffic and airport information.

PHRASEOLOGY-

RADAR SERVICE TERMINATED, SQUAWK ONE TWO ZERO ZERO,

or

SQUAWK VFR,

then

CHANGE TO ADVISORY FREQUENCY APPROVED,

or

CONTACT (frequency identification),

or

FREQUENCY CHANGE APPROVED.

7-6-12. SERVICE PROVIDED WHEN TOWER IS INOPERATIVE

a. Provide the following services during hours when the tower is not in operation:

- 1.** Wind direction and velocity.

NOTE-

Issue information provided from the FSS or WSO. Otherwise, inform the pilot that wind information is not available.

- 2.** Traffic information.

- 3.** Inform aircraft when radar service is terminated.

REFERENCE-

FAAO 7110.65, Radar Service Termination, Para 5-1-13

- b.** Do not assign landing sequence.

Section 7. Terminal Radar Service Area (TRSA)– Terminal

7-7-1. APPLICATION

Apply TRSA procedures within the designated TRSA in addition to the basic services described in Chapter 7, Visual, Section 6, Basic Radar Service to VFR Aircraft– Terminal.

REFERENCE–

FAAO 7110.65, *Visual Separation, Para 7-2-1*

7-7-2. ISSUANCE OF EFC

Inform the pilot when to expect further clearance when VFR aircraft are held either inside or outside the TRSA.

REFERENCE–

FAAO 7110.65, *Visual Separation, Para 7-2-1*

7-7-3. SEPARATION

Separate VFR aircraft from VFR/IFR aircraft by any one of the following:

a. Visual separation, as specified in para 7-2-1, Visual Separation, para 7-4-2, Vectors for Visual Approach, and para 7-6-7, Sequencing.

NOTE–

Issue wake turbulence cautionary advisories in accordance with para 2-1-20 Wake Turbulence Cautionary Advisories.

b. 500 feet vertical separation.

c. Target resolution when using broadband radar systems. The application of target resolutions at locations not using broadband radar will be individually approved by the Program Director for Air Traffic Planning and Procedures, ATP-1.

NOTE–

Apply the provisions of para 5-5-4 Minima, subparas e and f when wake turbulence separation is required.

REFERENCE–

FAAO 7110.65, *Visual Separation, Para 7-2-1*

7-7-4. HELICOPTER TRAFFIC

Helicopters need not be separated from other helicopters. Traffic information shall be exchanged, as necessary.

REFERENCE–

FAAO 7110.65, *Visual Separation, Para 7-2-1*

7-7-5. ALTITUDE ASSIGNMENTS

a. Altitude information contained in a clearance, instruction, or advisory to VFR aircraft shall meet MVA, MSA, or minimum IFR altitude criteria.

REFERENCE–

FAAO 7110.65, *Flight Direction, Para 4-5-2*

FAAO 7110.65, *Exceptions, Para 4-5-3*

FAAO 7110.65, *Minimum En Route Altitudes, Para 4-5-6*

b. If required, issue altitude assignments, consistent with the provisions of 14 CFR Section 91.119.

NOTE–

The MSAs are:

(1) Over congested areas, an altitude at least 1,000 feet above the highest obstacle; and

(2) Over other than congested areas, an altitude at least 500 feet above the surface.

c. When necessary to assign an altitude for separation purposes to VFR aircraft contrary to 14 CFR Section 91.159, advise the aircraft to resume altitudes appropriate for the direction of flight when the altitude assignment is no longer needed for separation or when leaving the TRSA.

PHRASEOLOGY–

RESUME APPROPRIATE VFR ALTITUDES.

REFERENCE–

FAAO 7110.65, *Practice Approaches, Para 4-8-1.*

FAAO 7110.65, *Application, Para 5-6-1*

FAAO 7110.65, *Visual Separation, Para 7-2-1*

7-7-6. APPROACH INTERVAL

The tower shall specify the approach interval.

REFERENCE–

FAAO 7110.65, *Visual Separation, Para 7-2-1*

7-7-7. TRSA DEPARTURE INFORMATION

a. At controlled airports within the TRSA, inform a departing aircraft proposing to operate within the TRSA when to contact departure control and the frequency to use. If the aircraft is properly equipped, ground control or clearance delivery shall issue the appropriate beacon code.

NOTE–

Departing aircraft are assumed to want TRSA service unless the pilot states, “negative TRSA service,” or makes a similar comment. Pilots are expected to inform the controller of intended destination and/or route of flight and altitude.

b. Provide separation until the aircraft leaves the TRSA.

c. Inform VFR participating aircraft when leaving the TRSA.

PHRASEOLOGY–
LEAVING THE (name) TRSA,

and as appropriate,

RESUME OWN NAVIGATION, REMAIN THIS FREQUENCY FOR TRAFFIC ADVISORIES, RADAR SERVICE TERMINATED, SQUAWK ONE TWO ZERO ZERO.

d. Aircraft departing satellite controlled airports that will penetrate the TRSA should be provided the same service as those aircraft departing the primary airport. Procedures for handling this situation shall be covered in a letter of agreement or facility directives, as appropriate.

e. Procedures for handling aircraft departing uncontrolled satellite airports must be advertised in a facility bulletin and service provided accordingly.

REFERENCE–
FAAO 7110.65, Visual Separation, Para 7–2–1

Section 8. Class C Service– Terminal

7–8–1. APPLICATION

Apply Class C service procedures within the designated Class C airspace and the associated outer area. Class C services are designed to keep ATC informed of all aircraft within Class C airspace, not to exclude operations. Two-way radio communications and operational transponder are normally required for operations within Class C airspace, but operations without radio communications or transponder can be conducted by LOA, facility directive, or special arrangement with Class C airspace controlling facility.

REFERENCE–

FAAO 7110.65, *Visual Separation, Para 7–2–1*
14 CFR Section 91.215, *ATC Transponder and Altitude Reporting Equipment and Use.*

7–8–2. CLASS C SERVICES

- a. Class C services include the following:
 1. Sequencing of all aircraft to the primary airport.
 2. Standard IFR services to IFR aircraft.
 3. Separation, traffic advisories, and safety alerts between IFR and VFR aircraft.
 4. Mandatory traffic advisories and safety alerts between VFR aircraft.
- b. Provide Class C services to all aircraft operating within Class C airspace.
- c. Provide Class C services to all participating aircraft in the outer area.
- d. Aircraft should not normally be held. However, if holding is necessary, inform the pilot of the expected length of delay.
- e. When a radar outage occurs, advise aircraft that Class C services are not available and, if appropriate, when to contact the tower.

REFERENCE–

FAAO 7110.65, *Visual Separation, Para 7–2–1*

7–8–3. SEPARATION

Separate VFR aircraft from IFR aircraft by any one of the following:

- a. Visual separation as specified in para 7–2–1, Visual Separation, para 7–4–2, Vectors for Visual Approach, and para 7–6–7, Sequencing.

NOTE–

Issue wake turbulence cautionary advisories in accordance with para 2–1–20 Wake Turbulence Cautionary Advisories.

- b. 500 feet vertical separation;
- c. Target resolution when using broadband radar systems. The application of target resolution at locations not using broadband radar will be individually approved by the Program Director for Air Traffic Planning and Procedures, ATP–1.

NOTE–

Apply the provisions of para 5–5–4 Minima, when wake turbulence separation is required.

REFERENCE–

FAAO 7110.65, *Visual Separation, Para 7–2–1*

7–8–4. ESTABLISHING TWO-WAY COMMUNICATIONS

Class C service requires pilots to establish two-way radio communications before entering Class C airspace. If the controller responds to a radio call with, “(a/c call sign) standby,” radio communications have been established and the pilot can enter Class C airspace. If workload or traffic conditions prevent immediate provision of Class C services, inform the pilot to remain outside Class C airspace until conditions permit the services to be provided.

PHRASEOLOGY–

(A/c call sign) REMAIN OUTSIDE CHARLIE AIRSPACE AND STANDBY.

REFERENCE–

FAAO 7110.65, *Visual Separation, Para 7–2–1*

7–8–5. ALTITUDE ASSIGNMENTS

- a. When necessary to assign altitudes to VFR aircraft, assign altitudes that meet the MVA, MSA, or minimum IFR altitude criteria.
- b. Aircraft assigned altitudes which are contrary to 14 CFR Section 91.159 shall be advised to resume altitudes appropriate for the direction of flight when

the altitude is no longer needed for separation, when leaving the outer area, or when terminating Class C service.

PHRASEOLOGY–

RESUME APPROPRIATE VFR ALTITUDES.

REFERENCE–

FAAO 7110.65, Visual Separation, Para 7–2–1

7–8–6. EXCEPTIONS

a. VFR helicopters need not be separated from IFR helicopters. Traffic information and safety alerts shall be issued as appropriate.

b. Hot air balloons need not be separated from IFR aircraft. Traffic information and safety alerts shall be issued as appropriate.

7–8–7. ADJACENT AIRPORT OPERATIONS

a. Aircraft that will penetrate Class C airspace after departing controlled airports within or adjacent to Class C airspace shall be provided the same services as those aircraft departing the primary

airport. Procedures for handling this situation shall be covered in a LOA or a facility directive, as appropriate.

b. Aircraft departing uncontrolled airports within Class C airspace shall be handled using procedures advertised in a Letter to Airmen.

7–8–8. TERMINATION OF SERVICE

Unless aircraft are landing at secondary airports or have requested termination of service while in the outer area, provide services until the aircraft departs the associated outer area. Terminate Class C service to aircraft landing at other than the primary airport at a sufficient distance from the airport to allow the pilot to change to the appropriate frequency for traffic and airport information.

PHRASEOLOGY–

CHANGE TO ADVISORY FREQUENCY APPROVED,

or

CONTACT (facility identification).

Section 9. Class B Service Area– Terminal

7–9–1. APPLICATION

Apply Class B services and procedures within the designated Class B airspace.

a. No person may operate an aircraft within Class B airspace unless:

1. The aircraft has an operable two-way radio capable of communications with ATC on appropriate frequencies for that Class B airspace.

2. The aircraft is equipped with the applicable operating transponder and automatic altitude reporting equipment specified in para (a) of 14 CFR Section 91.215, except as provided in para (d) of that section.

7–9–2. VFR AIRCRAFT IN CLASS B AIRSPACE

a. VFR aircraft must obtain an ATC clearance to operate in Class B airspace.

REFERENCE–

FAAO 7110.65, *Operational Requests, Para 2–1–18*

FAAO 7110.65, *Airspace Classes, Para 2–4–22*

PHRASEOLOGY–

CLEARED THROUGH/TO ENTER/OUT OF BRAVO AIRSPACE,

and as appropriate,

VIA (route). MAINTAIN (altitude) WHILE IN BRAVO AIRSPACE.

or

CLEARED AS REQUESTED.

(Additional instructions, as necessary.)

REMAIN OUTSIDE BRAVO AIRSPACE. (When necessary, reason and/or additional instructions.)

NOTE–

1. Assignment of radar headings, routes, or altitudes is based on the provision that a pilot operating in accordance with VFR is expected to advise ATC if compliance will cause violation of any part of the CFR.

2. Separation and sequencing for VFR aircraft is dependent upon radar. Efforts should be made to segregate VFR traffic from IFR traffic flows when a radar outage occurs.

b. Approve/deny requests from VFR aircraft to operate in Class B airspace based on workload, operational limitations and traffic conditions.

c. Inform the pilot when to expect further clearance when VFR aircraft are held either inside or outside Class B airspace.

d. Inform VFR aircraft when leaving Class B airspace.

PHRASEOLOGY–

LEAVING (name) BRAVO AIRSPACE,

and as appropriate,

RESUME OWN NAVIGATION, REMAIN THIS FREQUENCY FOR TRAFFIC ADVISORIES, RADAR SERVICE TERMINATED, SQUAWK ONE TWO ZERO ZERO.

7–9–3. METHODS

a. To the extent practical, clear large turbine engine-powered airplanes to/from the primary airport using altitudes and routes that avoid VFR corridors and airspace below the Class B airspace floor where VFR aircraft are operating.

NOTE–

Pilots operating in accordance with VFR are expected to advise ATC if compliance with assigned altitudes, headings, or routes will cause violation of any part of the CFR.

b. Vector aircraft to remain in Class B airspace after entry. Inform the aircraft when leaving and reentering Class B airspace if it becomes necessary to extend the flight path outside Class B airspace for spacing.

NOTE–

14 CFR Section 91.131 states that “Unless otherwise authorized by ATC, each person operating a large turbine engine-powered airplane to or from a primary airport for which a Class B airspace area is designated must operate at or above the designated floors of the Class B airspace area while within the lateral limits of that area.” Such authorization should be the exception rather than the rule.

REFERENCE–

FAAO 7110.65, *Deviation Advisories, Para 5–1–10*

c. Aircraft departing controlled airports within Class B airspace will be provided the same services as those aircraft departing the primary airport.

REFERENCE-

FAAO 7110.65, *Operational Requests, Para 2-1-18*

7-9-4. SEPARATION

a. Standard IFR services to IFR aircraft.

b. VFR aircraft shall be separated from VFR/IFR aircraft that weigh more than 19,000 pounds and turbojets by no less than:

1. 1 1/2 miles separation, or
2. 500 feet vertical separation, or

NOTE-

Apply the provisions of para 5-5-4 Minima, when wake turbulence separation is required.

3. Visual separation, as specified in para 7-2-1, Visual Separation, para 7-4-2, Vectors for Visual Approach, and para 7-6-7, Sequencing.

NOTE-

Issue wake turbulence cautionary advisories in accordance with para 2-1-20 Wake Turbulence Cautionary Advisories.

c. VFR aircraft shall be separated from all VFR/IFR aircraft which weigh 19,000 pounds or less by a minimum of:

1. Target resolution, or
2. 500 feet vertical separation, or

NOTE-

1. *Apply the provisions of para 5-5-4 Minima, when wake turbulence separation is required.*

2. *Aircraft weighing 19,000 pounds or less include all aircraft in SRS Categories I and II plus G73, STAR, S601, BE30, SW3, B190 and C212.*

3. Visual separation, as specified in para 7-2-1, Visual Separation, para 7-4-2, Vectors for Visual Approach, and para 7-6-7, Sequencing.

NOTE-

Issue wake turbulence cautionary advisories in accordance with para 2-1-20 Wake Turbulence Cautionary Advisories.

REFERENCE-

P/CG Term- Lateral Separation.

P/CG Term- Radar Separation.

P/CG Term- Target Resolution.

P/CG Term- Visual Separation.

7-9-5. TRAFFIC ADVISORIES

a. Provide mandatory traffic advisories and safety alerts, between all aircraft.

b. Apply merging target procedures in accordance with para 5-1-8, Merging Target Procedures.

7-9-6. HELICOPTER TRAFFIC

VFR helicopters need not be separated from VFR or IFR helicopters. Traffic advisories and safety alerts shall be issued as appropriate.

7-9-7. ALTITUDE ASSIGNMENTS

a. Altitude information contained in a clearance, instruction, or advisory to VFR aircraft shall meet MVA, MSA, or minimum IFR altitude criteria.

b. Issue altitude assignments, if required, consistent with the provisions of 14 CFR Section 91.119.

NOTE-

The MSAs are:

1. *Over congested areas, an altitude at least 1,000 feet above the highest obstacle,*
2. *Over other than congested areas, an altitude at least 500 feet above the surface.*

REFERENCE-

FAAO 7110.65, *Flight Direction, Para 4-5-2*

FAAO 7110.65, *Exceptions, Para 4-5-3*

FAAO 7110.65, *Minimum En Route Altitudes, Para 4-5-6*

c. Aircraft assigned altitudes which are contrary to 14 CFR Section 91.159 shall be advised to resume altitudes appropriate for the direction of flight when the altitude assignment is no longer required or when leaving Class B airspace.

PHRASEOLOGY-

RESUME APPROPRIATE VFR ALTITUDES.

7-9-8. APPROACH INTERVAL

The tower shall specify the approach interval.

Chapter 8. Offshore/Oceanic Procedures

Section 1. General

8-1-1. ATC SERVICE

Provide air traffic control service in oceanic controlled airspace in accordance with the procedures in this chapter except when other procedures/minima are prescribed in a directive or a letter of agreement.

REFERENCE-

FAAO 7110.65, Procedural Letters of Agreement, Para 1-1-8

8-1-2. OPERATIONS IN OFFSHORE AIRSPACE AREAS

Provide air traffic control service in offshore airspace areas in accordance with procedures and minima in this chapter. For those situations not covered by this chapter, the provisions in this Order shall apply.

8-1-3. VFR FLIGHT PLANS

VFR flights in Oceanic FIRs may be conducted in meteorological conditions equal to or greater than those specified in 14 CFR Section 91.155, Basic VFR weather minimums. Operations on a VFR flight plan are permitted only between sunrise and sunset and only within:

- a. Miami, Houston, and San Juan Oceanic Control Areas (CTAs) at or below FL 180.
- b. Within the Oakland FIR when operating less than 100 NM seaward from the shoreline within controlled airspace.
- c. All Oceanic FIR airspace below the Oceanic CTAs.

8-1-4. TYPES OF SEPARATION

Separation shall consist of at least one of the following:

- a. Vertical separation;
- b. Horizontal separation, either;
 - 1. Longitudinal; or
 - 2. Lateral;
- c. Composite separation;

- d. Radar separation, as specified in Chapter 5, Radar, where radar coverage is adequate.

8-1-5. ALTIMETER SETTING

Within oceanic control areas, unless directed and/or charted otherwise, altitude assignment shall be based on flight levels and a standard altimeter setting of 29.92 inches Hg.

8-1-6. RECEIPT OF POSITION REPORTS

When a position report affecting separation is not received, take action to obtain the report no later than *10 minutes* after the control estimate, unless otherwise specified.

8-1-7. OCEANIC NAVIGATIONAL ERROR REPORTING (ONER) PROCEDURES

FAAO 7110.82, Monitoring of Navigation, Longitudinal Separation, and Altitude Keeping Performance in Oceanic Airspace, contains procedures for reporting and processing navigational errors observed by ATC radar for aircraft exiting oceanic airspace.

NOTE-

FAAO 7110.82 establishes procedures for processing ONER procedures, Oceanic Altitude Deviation Reports, Erosion of Longitudinal Separation Reports, Letter of Authorization Verification Reports, and for collecting system data for analysis. This data is needed for risk modeling activities to support separation standard reductions.

8-1-8. USE OF CONTROL ESTIMATES

Control estimates are the estimated position of aircraft, with reference to time as determined by the ATC automation system in use or calculated by the controller using known wind patterns, previous aircraft transit times, pilot progress reports, and pilot estimates. These estimates may be updated through the receipt of automated position reports and/or manually updated by the controller. Control estimates shall be used when applying time-based separation minima.

Section 2. Coordination

8-2-1. GENERAL

ARTCCs shall:

- a. Forward to appropriate ATS facilities, as a flight progresses, current flight plan and control information.
- b. Coordinate flight plan and control information in sufficient time to permit the receiving facility to analyze the data and to effect any necessary additional coordination. This may be specified in a letter of agreement.
- c. Coordinate with adjacent ATS facilities when airspace to be protected will overlap the common boundary.
- d. Forward revisions of estimates of *3 minutes* or more to the appropriate ATS facility.
- e. Coordinate with adjacent facilities on IFR and VFR flights to ensure the continuation of appropriate air traffic services.

8-2-2. TRANSFER OF CONTROL AND COMMUNICATIONS

- a. Only one air traffic control unit shall control an aircraft at any given time.
- b. The control of an aircraft shall be transferred from one control unit to another at the time the aircraft

is estimated to cross the control boundary or at such other point or time agreed upon by the two units.

- c. The transferring unit shall forward to the accepting unit any changed flight plan or control data which are pertinent to the transfer.
- d. The accepting unit shall notify the transferring unit if it is unable to accept control under the terms specified, or it shall specify the changes or conditions required so that the aircraft can be accepted.
- e. The accepting unit shall not alter the clearance of an aircraft that has not yet reached the transfer of control point without the prior approval of the transferring unit.
- f. Where nonradar separation minima are being applied, the transfer of air-ground communications with an aircraft shall be made *5 minutes* before the time at which the aircraft is estimated to reach the boundary unless otherwise agreed to by the control and/or communication units concerned.

8-2-3. AIR TRAFFIC SERVICES INTERFACILITY DATA COMMUNICATIONS (AIDC)

Where interfacility data communications capability has been implemented, its use for ATC coordination should be accomplished in accordance with regional Interface Control Documents, and supported by letters of agreement between the facilities concerned.

Section 3. Longitudinal Separation

8-3-1. APPLICATION

a. Longitudinal separation shall be applied so that the spacing between the estimated positions of the aircraft being separated is never less than a prescribed minimum.

NOTE-

Consider separation to exist when the estimated positions of the aircraft being separated are never less than a prescribed minimum.

b. In situations where one aircraft requires a different time-based longitudinal standard than another, apply the larger of the two standards between the aircraft concerned.

c. Longitudinal separation expressed in distance may be applied as prescribed in Chapter 6, Nonradar.

d. In situations where an update to a control estimate indicates that the minimum being applied no longer exists, controllers shall ensure that separation is reestablished. Issue traffic information as necessary.

8-3-2. SEPARATION METHODS

a. For the purpose of application of longitudinal separation, the terms *same track* shall be considered identical to *same course*, *reciprocal tracks* shall be considered identical to *reciprocal courses*, and *crossing tracks*, shall be considered identical to *crossing courses*.

NOTE-

Refer to para 1-2-2, Course Definitions.

b. Separate aircraft longitudinally in accordance with the following:

1. Same track. Ensure that the estimated spacing between aircraft is not less than the applicable minimum required. (See FIG 8-3-1.)

FIG 8-3-1

Same Courses

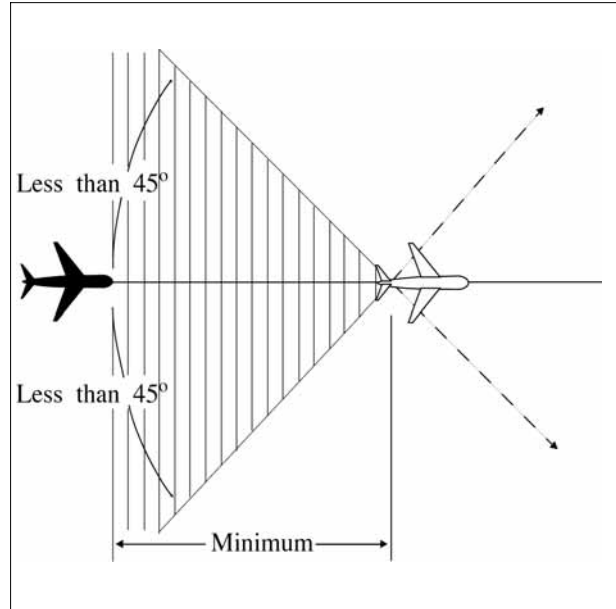

2. Crossing tracks. Ensure that the estimated spacing at the point of intersection is not less than the applicable minimum required. (See FIG 8-3-2.)

FIG 8-3-2

Crossing Courses

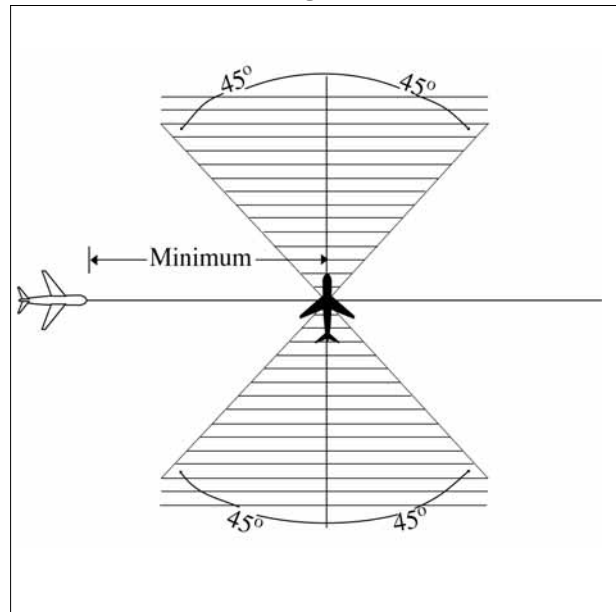

3. Reciprocal tracks:

(a) Ensure that aircraft are vertically separated for a time interval equal to the applicable minimum required before and after the aircraft are estimated to pass. (See FIG 8-3-3.)

FIG 8-3-3

Reciprocal Courses

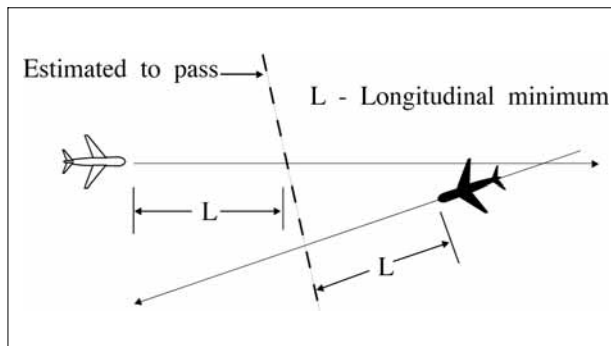

(b) Vertical separation may be discontinued after one of the following conditions are met:

(1) Both aircraft have reported passing a significant point and the aircraft are separated by at least the applicable minimum required for the same direction longitudinal spacing; (See FIG 8-3-4.) or

FIG 8-3-4

Vertical Separation

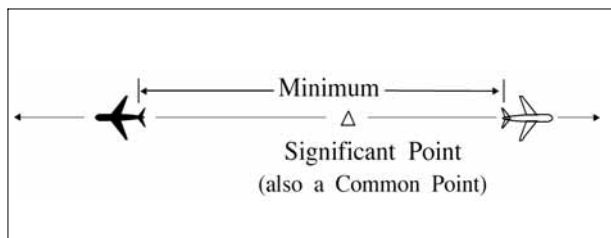

(2) Both aircraft have reported passing ground-based NAVAIDs or DME fixes indicating that they have passed each other.

8-3-3. MACH NUMBER TECHNIQUE

The use of Mach number technique allows for the application of reduced longitudinal separation minima. The following conditions shall be met when the Mach number technique is being applied:

a. Aircraft Types: Turbojet aircraft only.

b. Routes:

1. The aircraft follow the same track or continuously diverging tracks, and

2. The aircraft concerned have reported over a common point; or

3. If the aircraft have *not* reported over a common point, the appropriate time interval being applied between aircraft exists and will exist at the common point; or,

4. If a common point does not exist, the appropriate time interval being applied between aircraft exists and will exist at significant points along each track.

c. Altitudes:

1. Assign only a single cardinal altitude to each aircraft.

2. The aircraft concerned are in level, climbing or descending flight.

d. Mach Number Assignment:

1. A Mach number (or, when appropriate, a range of Mach numbers) shall be issued to each aircraft unless otherwise prescribed on the basis of ICAO regional agreement.

NOTE-

1. *The application of Mach number technique requires pilots to strictly adhere to the last assigned Mach number (or range of Mach numbers), even during climbs and descents, unless revised by ATC. Turbojet aircraft shall request ATC approval before making any changes. If it is essential to make an immediate temporary change in the Mach number (e.g., due to turbulence), ATC shall be notified as soon as possible that such a change has been made.*

2. *When it is necessary to issue crossing restrictions to ensure the appropriate time interval, it may be impossible for an aircraft to comply with both the clearance to meet the crossing restrictions and the clearance to maintain a single, specific Mach number.*

REFERENCE-

ICAO DOC 9426-AN/924, Part II, Section 2, Para 2.3.4, Para 2.4.7, and Para 2.5.3.

EXAMPLE-

“Maintain Mach point eight four or greater.”

“Maintain Mach point eight three or less.”

“Maintain Mach point eight two or greater; do not exceed Mach point eight four.”

e. Longitudinal Minima:

When the Mach number technique is applied, minimum longitudinal separation shall be:

1. 10 minutes, provided that:

(a) The preceding aircraft maintains a Mach number equal to, or greater than that maintained by the following aircraft; or

(b) When the following aircraft is faster than the preceding aircraft, at least *10 minutes* exists until another form of separation is achieved; or

2. Between 9 and 5 minutes inclusive, provided that the preceding aircraft is maintaining a Mach number greater than the following aircraft in accordance with the following:

(a) *9 minutes*, if the preceding aircraft is Mach 0.02 faster than the following aircraft;

(b) *8 minutes*, if the preceding aircraft is Mach 0.03 faster than the following aircraft;

(c) *7 minutes*, if the preceding aircraft is Mach 0.04 faster than the following aircraft;

(d) *6 minutes*, if the preceding aircraft is Mach 0.05 faster than the following aircraft;

(e) *5 minutes*, if the preceding aircraft is Mach 0.06 faster than the following aircraft.

NOTE-

A “rule-of-thumb” may be applied to assist in providing the required estimated spacing over the oceanic exit point when either conflict probe is not in use or when requested by another facility. This rule-of-thumb can be stated as follows: For each 600 NM in distance between the entry and exit points of the area where the Mach Number Technique is used, add 1 minute for each 0.01 difference in Mach number for the two aircraft concerned to compensate for the fact that the second aircraft is overtaking the first aircraft. (See TBL 8-3-1.)

TBL 8-3-1

Application of the Mach Number Technique When the Following Aircraft is Faster

Difference in Mach	Distance to Fly and Separation (in Minutes) Required at Entry Point				
	001-600 NM	601-1200 NM	1201-1800 NM	1801-2400 NM	2401-3000 NM
0.01	11	12	13	14	15
0.02	12	14	16	18	20
0.03	13	16	19	22	25
0.04	14	18	22	26	30
0.05	15	20	25	30	35
0.06	16	22	28	34	40
0.07	17	24	31	38	45
0.08	18	26	34	42	50
0.09	19	28	37	46	55
0.10	20	30	40	50	60

Section 4. Lateral Separation

8-4-1. APPLICATION

Separate aircraft by assigning different flight paths whose widths or protected airspace do not overlap.

Within that portion of the Gulf of Mexico Low Offshore airspace controlled by Houston ARTCC, use 12 NM between aircraft whose flight paths are defined by published Grid System waypoints.

NOTE-

1. The Grid System is defined as those waypoints contained within the Gulf of Mexico Low Offshore airspace and published on the IFR Vertical Flight Reference Chart.

2. Lateral separation minima is contained in:
 Section 7, North Atlantic ICAO Region.
 Section 8, Caribbean ICAO Region.
 Section 9, Pacific ICAO Region.
 Section 10, North American ICAO Region- Arctic CTA.

8-4-2. SEPARATION METHODS

Lateral separation exists for:

a. Nonintersecting flight paths:

1. When the required distance is maintained between the flight paths; or (See FIG 8-4-1.)

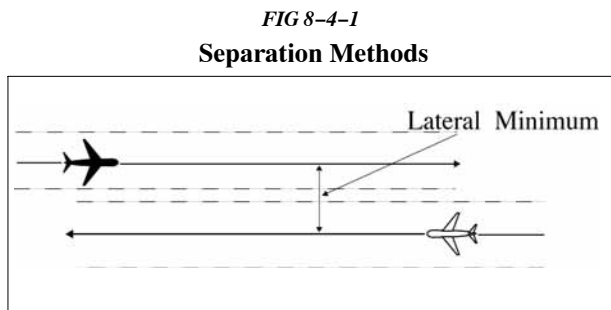

2. When reduced route protected airspace is applicable, and the protected airspace of the flight paths do not overlap; or (See FIG 8-4-2.)

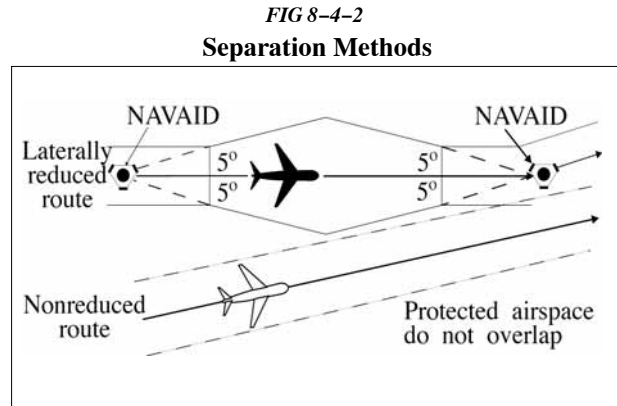

3. When aircraft are crossing an oceanic boundary and are entering an airspace with a larger lateral minimum than the airspace being exited; and

- (a) The smaller separation exists at the boundary; and
 (b) Flight paths diverge by 15° or more until the larger minimum is established. (See FIG 8-4-3.)

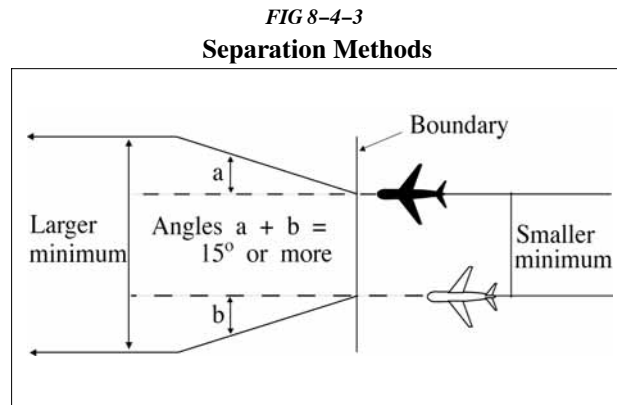

b. Intersecting flight paths with constant and same width protected airspace when either aircraft is at or beyond a distance equal to the applicable lateral separation minimum measured perpendicular to the flight path of the other aircraft. (See FIG 8-4-4.)

FIG 8-4-4
Separation Methods

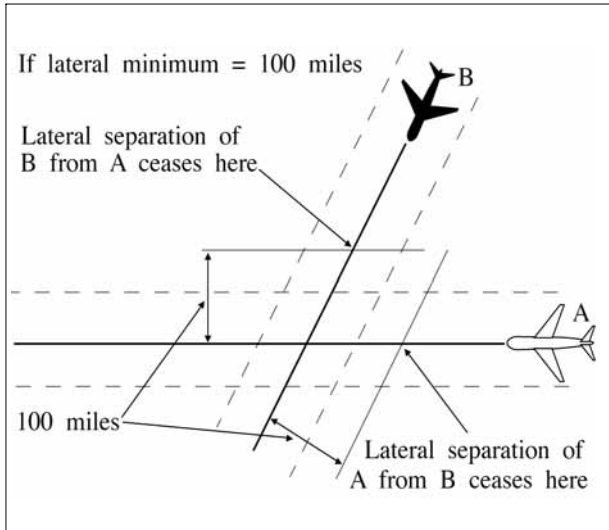

c. Intersecting flight paths with constant but different width protected airspace when either aircraft is at or beyond a distance equal to the sum of the protected airspace of both flight paths measured perpendicular to the flight path of the other aircraft. (See FIG 8-4-5.)

FIG 8-4-5
Separation Methods

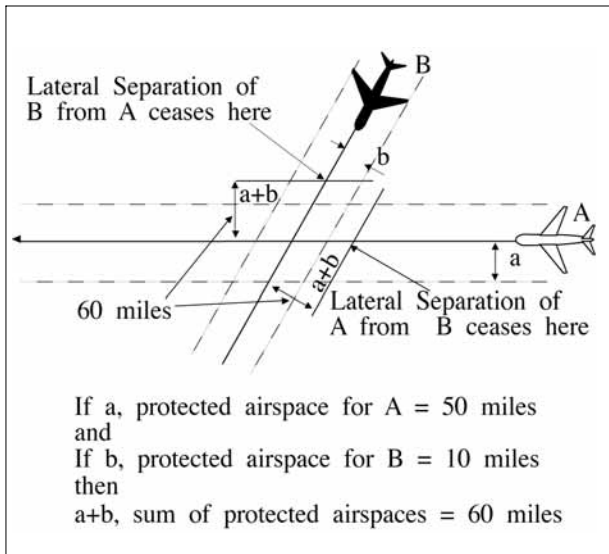

d. Intersecting flight paths with variable width protected airspace when either aircraft is at or beyond a distance equal to the sum of the protected airspace of both flight paths measured perpendicular to the flight path of the other aircraft. Measure protected airspace for each aircraft perpendicular to its flight path at the first point or the last point, as applicable, of protected airspace overlap.

NOTE-
In FIG 8-4-6, the protected airspace for westbound flight A is distance "a" (50 miles), and for southwestbound flight B, distance "b" (10 miles). Therefore, the sum of distances "a" and "b"; i.e., the protected airspace of Aircrafts A and B, establishes the lateral separation minimum (60 miles) applicable for either flight relevant to the other.

FIG 8-4-6
Separation Methods

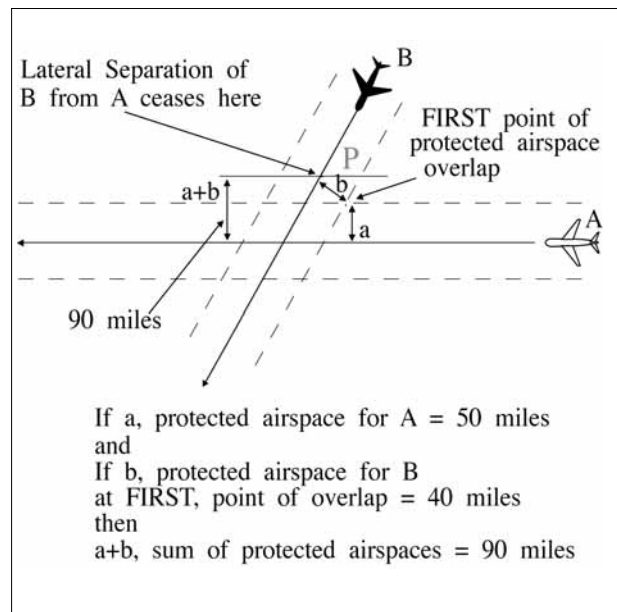

NOTE-
(See FIG 8-4-6.) At the first point of protected airspace overlap, the protected airspace for westbound flight A is distance "a" (50 miles), and for southbound flight B, distance "b" (40 miles). The sum of distances "a" and "b" (90 miles) establishes the lateral separation minimum applicable in this example for either flight as it approaches the intersection. For example, Aircraft B should be vertically separated from Aircraft A by the time it reaches point "p."

FIG 8-4-7

Separation Methods

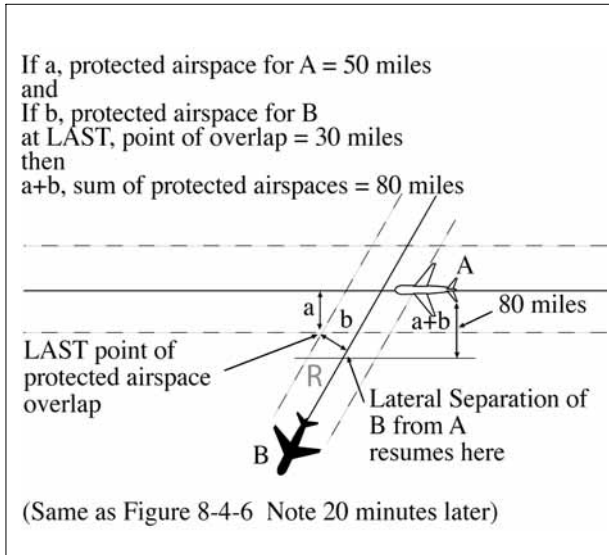

NOTE-

(See FIG 8-4-7.) Distance “a” (50 miles) and “b” (30 miles) are determined at the last point of protected airspace overlap. The sum of the distances “a” and “b” (80 miles) establishes the lateral separation minima applicable for either flight after it passes beyond the intersection. For example, Aircraft B could be cleared to, or through, Aircraft A’s altitude after passing point “r.”

8-4-3. REDUCTION OF ROUTE PROTECTED AIRSPACE

When routes have been satisfactorily flight checked and notice has been given to users, reduction in route protected airspace may be made as follows:

a. Below FL 240, reduce the width of the protected airspace to 5 miles on each side of the route centerline to a distance of 57.14 miles from the NAVAID, then increasing in width on a 5° angle from the route centerline, measured at the NAVAID, to the maximum width allowable within the lateral minima; for example, 50 miles of protected airspace on each side of centerline; i.e., a lateral minimum of 100 miles. (See FIG 8-4-8.)

FIG 8-4-8

Reduction of Route Protected Airspace

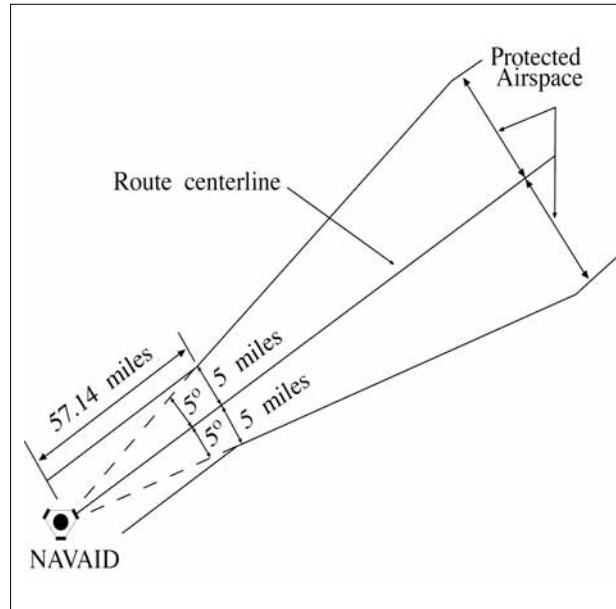

b. At and above FL 240, reduce the width of the protected airspace to 10 miles on each side of the route centerline to a distance of 114.29 miles from the NAVAID, then increasing in width on a 5° angle from the route centerline, as measured at the NAVAID, to the maximum width allowable within the lateral minima; for example, 60 miles of protected airspace on each side of the centerline; i.e., a lateral separation minimum of 120 miles. (See FIG 8-4-9.)

FIG 8-4-9

Reduction of Route Protected Airspace

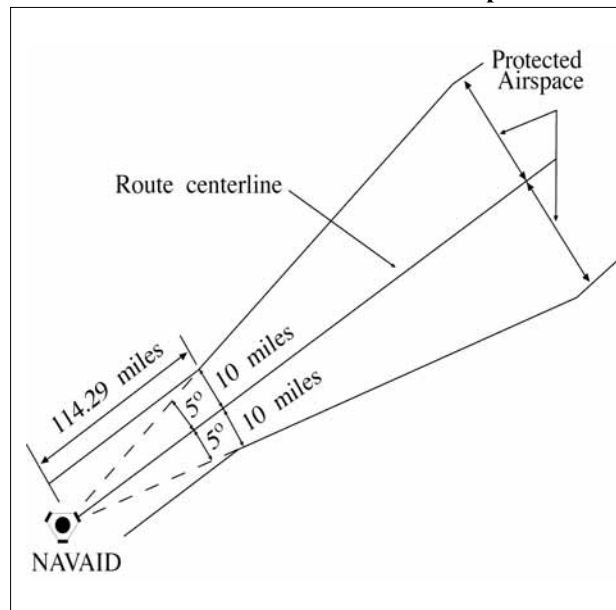

8-4-4. TRACK SEPARATION

Apply track separation between aircraft by requiring aircraft to fly specified tracks or radials and with specified spacings as follows:

a. Same NAVAID:

1. VOR/VORTAC/TACAN. Consider separation to exist between aircraft established on radials of the same NAVAID that diverge by at least 15 degrees when either aircraft is clear of the airspace to be protected for the other aircraft. Use TBL 8-4-1 to determine the flight distance required for various divergence angles and altitudes to clear the airspace to be protected. (See FIG 8-4-10.)

TBL 8-4-1

**Divergence-Distance Minima
VOR/VORTAC/TACAN**

Divergence (degrees)	Distance (mile)	
	FL 230 and below	Fl 240 through FL 450
15-25	17	18
26-35	11	13
36-90	8	11

Note: This table compensates for DME slant range error.

FIG 8-4-10

Track Separation VOR

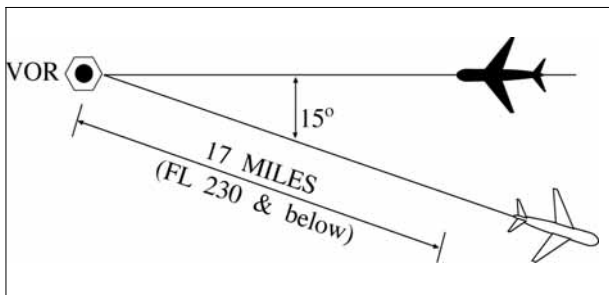

2. NDB:

(a) Consider separation to exist between aircraft established on tracks of the same NAVAID that diverge by at least 30 degrees and one aircraft is at least 15 miles from the NAVAID. This separation shall not be used when one or both aircraft are inbound to the aid unless the distance of the aircraft from the facility can be readily determined by reference to the NAVAID. Use TBL 8-4-2 to determine the flight distance required for various divergence angles to clear the airspace to be protected. For divergence that falls between two values, use the lesser value to obtain the distance. (See FIG 8-4-11.)

TBL 8-4-2

Divergence-Distance Minima (NDB)

Divergence (degrees)	Distance (mile)	
	FL 230 and below	FL 240 through FL 450
30	16	17
45	13	14
60	9	10
75	7	8
90	6	7

Note: This table compensates for DME slant range error.

FIG 8-4-11

Track Separation NDB

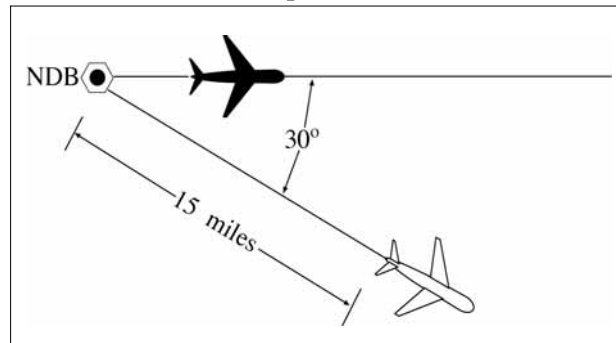

(b) Clear aircraft navigating on NDB facilities in accordance with para 2-5-2, NAVAID Terms.

b. Different NAVAIDs: Separate aircraft using different navigation aids by assigning tracks so that their protected airspace does not overlap. (See FIG 8-4-12.)

FIG 8-4-12

**Track Separation
Different NAVAIDs**

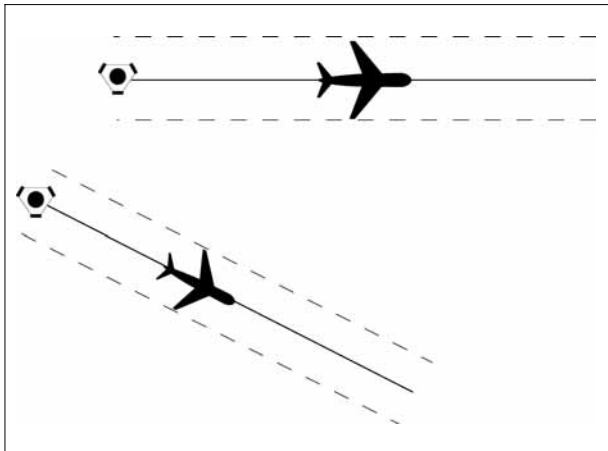

c. Dead Reckoning (DR):

1. Consider separation to exist between aircraft established on tracks that diverge by at least 45 degrees when one aircraft is at least 15 miles from the point of intersection of the tracks. This point may be determined either visually or by reference to a ground-based navigation aid. (See FIG 8-4-13.)

FIG 8-4-13

**Track Separation
Dead Reckoning**

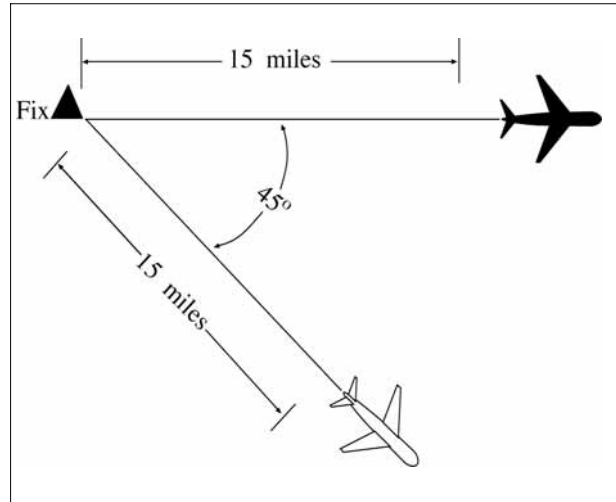

Section 5. Offshore/Oceanic Transition Procedures

8-5-1. ALTITUDE/FLIGHT LEVEL TRANSITION

When vertical separation is applied between aircraft crossing the offshore/oceanic airspace boundary below FL 180, control action shall be taken to ensure that differences between the standard altimeter setting (QNE) and local altimeter setting (QNH) do not compromise separation. (See FIG 8-5-1.)

FIG 8-5-1

Standard and Local Altimeter Setting Differences

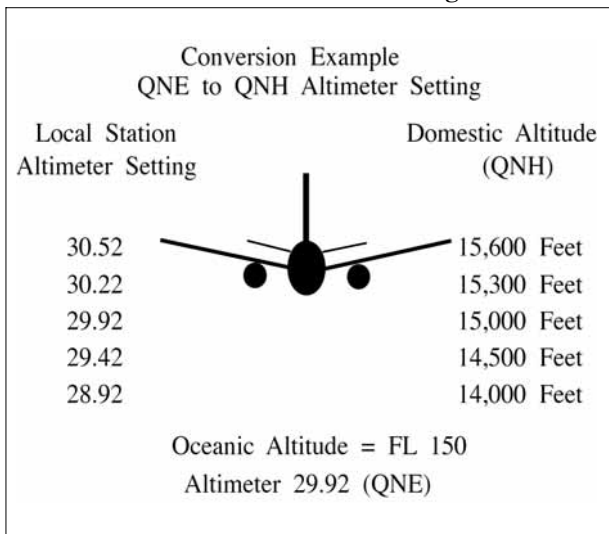

8-5-2. COURSE DIVERGENCE

When aircraft are entering oceanic airspace, separation will exist in oceanic airspace when:

- a. Aircraft are established on courses that diverge by at least 15 degrees until oceanic lateral separation is established, and

- b. The aircraft are horizontally radar separated and separation is increasing at the edge of known radar coverage.

8-5-3. OPPOSITE DIRECTION

When transitioning from an offshore airspace area to oceanic airspace, an aircraft may climb through opposite direction oceanic traffic provided vertical separation above that traffic is established:

- a. Before the outbound crosses the offshore/oceanic boundary; and
- b. 15 minutes before the aircraft are estimated to pass. (See FIG 8-5-2.)

FIG 8-5-2

Transitioning From Offshore to Oceanic Airspace Opposite Direction

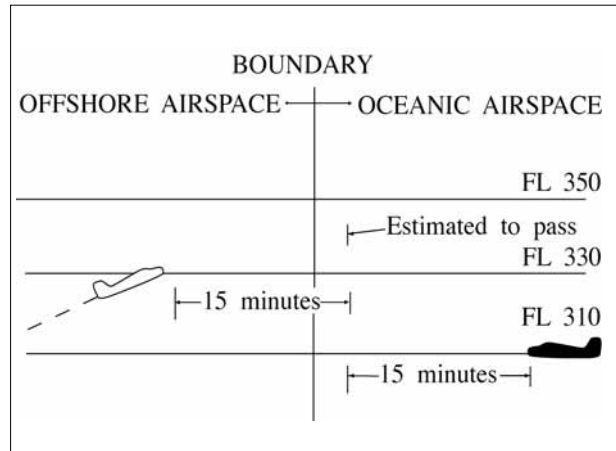

8-5-4. SAME DIRECTION

When transitioning from an offshore airspace area to oceanic airspace or while within oceanic airspace, apply 5 minutes minimum separation when a following aircraft on the same course is climbing through the altitude of the preceding aircraft if the following conditions are met:

- a. The preceding aircraft is level at the assigned altitude and is maintaining a speed equal to or greater than the following aircraft; and
- b. The minimum of 5 *minutes* is maintained between the preceding and following aircraft; and
- c. The following aircraft is separated by not more than 4,000 feet from the preceding aircraft when the climb clearance is issued; and
- d. The following aircraft commences climb within 10 *minutes* after passing:
 - 1. An exact reporting point (DME fix or intersection formed from NAVAIDs) which the preceding aircraft has reported; or
 - 2. A radar observed position over which the preceding aircraft has been observed; and

e. The following aircraft is in direct communication with air traffic control until vertical separation is established. (See FIG 8-5-3.)

FIG 8-5-3

Transitioning From Offshore to Oceanic Airspace Same Direction

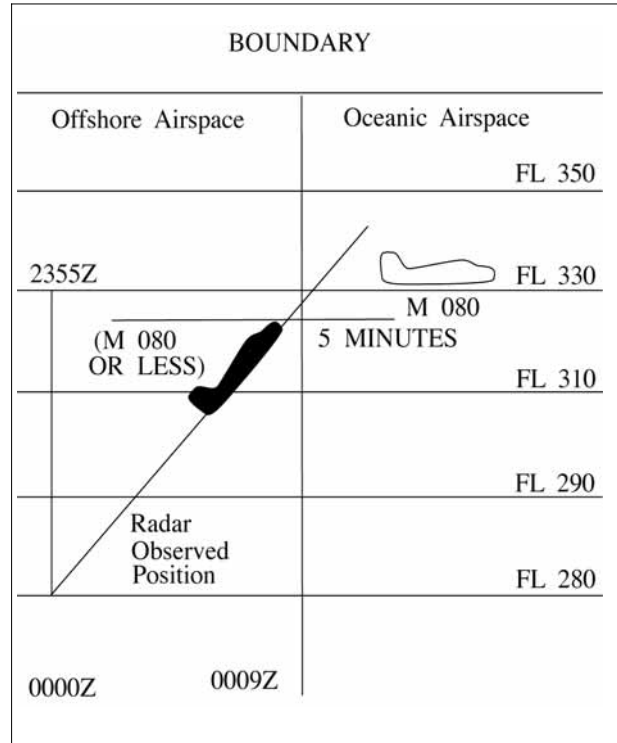

Section 6. Separation from Airspace Reservations

8-6-1. TEMPORARY STATIONARY AIRSPACE RESERVATIONS

Separate aircraft from a temporary stationary reservation by one of two methods:

a. Laterally: Clear aircraft so that the protected airspace along the route of flight does not overlap the geographical area of the stationary reservation. (See FIG 8-6-1.)

FIG 8-6-1

Temporary Stationary Airspace Reservations
Lateral Separation

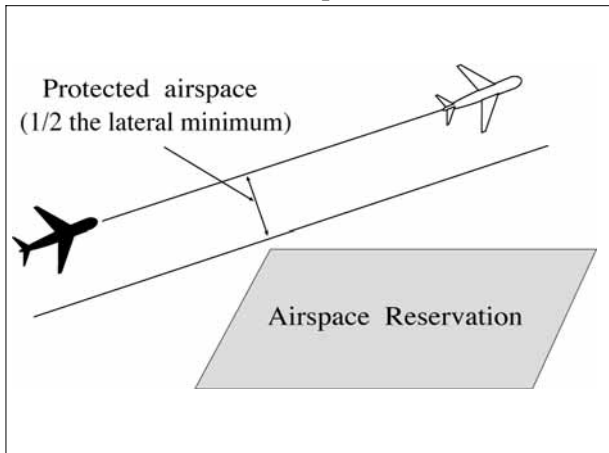

b. Vertically: Clear aircraft so that vertical separation exists while the aircraft is within a geographical area defined as the stationary reservation plus a buffer around the perimeter equivalent to one-half the lateral separation minimum. (See FIG 8-6-2.)

FIG 8-6-2

Temporary Stationary Airspace Reservations
Vertical Separation

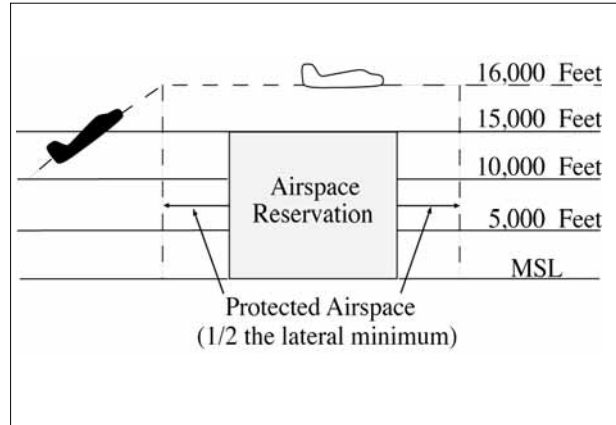

8-6-2. REFUSAL OF AVOIDANCE CLEARANCE

If a pilot refuses to accept a clearance to avoid a reservation, inform him/her of the potential hazard, advise him/her that services will not be provided while the flight is within the reservation and, if possible, inform the appropriate using agency.

8-6-3. TEMPORARY MOVING AIRSPACE RESERVATIONS

Separate aircraft from a temporary moving airspace reservation by one of the following methods:

a. Laterally: Clear aircraft so that the protected airspace along the route of flight does not overlap the (time-dependent) geographical area of the moving airspace reservation.

b. Longitudinally: Clear aircraft so that the appropriate longitudinal minimum exists ahead of the first or behind the last aircraft operating within the reservation.

c. Vertically: Clear aircraft so that vertical separation exists while the aircraft is within a (time-dependent) geographical area defined as the moving airspace reservation plus a buffer around the perimeter equivalent to one-half the lateral separation minimum.

Section 7. North Atlantic ICAO Region

8-7-1. APPLICATION

Provide air traffic control services in the North Atlantic ICAO Region with the procedures and minima contained in this section except when noted otherwise.

8-7-2. VERTICAL SEPARATION

Provide vertical separation in accordance with Chapter 4, IFR, Section 5, Altitude Assignment and Verification.

8-7-3. LONGITUDINAL SEPARATION

In accordance with Chapter 8, Offshore/Oceanic Procedures, Section 3, Longitudinal Separation, apply the following:

a. Supersonic flight:

1. *10 minutes* provided that:

(a) both aircraft are in level flight at the same Mach number or the aircraft are of the same type and are both operating in cruise climb, and one of the following;

(1) The aircraft concerned have reported over a common point; or,

(2) If the aircraft have not reported over a common point, the appropriate time interval being applied between aircraft exists and will exist at the common point; or,

(3) If a common point does not exist, the appropriate time interval being applied between aircraft exists and will exist at significant points along each track.

2. *15 minutes* between aircraft in supersonic flight not covered in subpara a1 above.

b. Turbojet operations (*subsonic flight*):

1. Apply the prescribed minima in accordance with para 8-3-3, Mach Number Technique; or

2. Where tracks diverge from the common point and the following aircraft is maintaining a greater Mach Number than the preceding aircraft:

(a) At least *10 minutes* longitudinal separation exists at the point where the tracks diverge; and

(b) At least *5 minutes* longitudinal separation will exist where minimum lateral separation is achieved (*whichever is estimated to occur first*);

(1) At or before the next significant point (normally within ten degrees of longitude along track(s)), or

(2) Within 90 minutes of the time the following aircraft passes the common point, or

(3) Within 600 NM of the common point.

3. Apply *15 minutes* between all other turbojet aircraft.

c. Nonturbojet operations:

1. Apply *20 minutes* between aircraft operating in the West Atlantic Route System (WATRS), or

2. Apply *30 minutes* between aircraft operating outside of the WATRS.

NOTE-

The WATRS area is defined as beginning at a point 27°00'N/77°00'W direct to 20°00'N/67°00'W direct to 18°00'N/62°00'W direct to 18°00'N/60°00'W direct to 38°30'N/60°00'W direct to 38°30'N/69°15'W, thence counterclockwise along the New York Oceanic CTA/FIR boundary to the Miami Oceanic CTA/FIR boundary, thence southbound along the Miami Oceanic CTA/FIR boundary to the point of beginning.

8-7-4. LATERAL SEPARATION

In accordance with Chapter 8, Offshore/Oceanic Procedures, Section 4, Lateral Separation, apply the following:

a. 60 NM or 1 degree latitude between:

1. Supersonic aircraft operating above FL 275.

2. Aircraft which meet the MNPS and which:

NOTE-

This reduced lateral separation shall not be used if track keeping capability of the aircraft has been reduced for any reason.

- (a) Operate within MNPS airspace; or
 - (b) Are in transit to or from MNPS airspace;
- or
- (c) Operate for part of their flight within MNPS airspace but are cleared to operate immediately above or below such airspace for a portion of their flight.

b. 90 NM or 1 and 1/2 degrees latitude between aircraft operating:

1. Within *WATRS*;
2. Between the U.S., Canada, and Bermuda;
3. West of 55° West between the U.S., Canada, or Bermuda and points in the Caribbean ICAO Region.

c. 120 NM or 2 degrees latitude between aircraft not covered by subparas a or b above.

NOTE—

Tracks may be spaced with reference to their difference in latitude, provided that in any interval of 10 degrees of longitude the change in latitude of at least one of the tracks does not exceed 3 degrees when operating south of 58° North.

8-7-5. PROCEDURES FOR WEATHER DEVIATIONS IN NORTH ATLANTIC (NAT) AIRSPACE

Aircraft must request an ATC clearance to deviate. Since aircraft will not fly into known areas of weather, weather deviation requests should take priority over routine requests. If there is no traffic in the horizontal dimension, ATC shall issue clearance to deviate from track; or if there is conflicting traffic in the horizontal dimension, ATC separates aircraft by establishing vertical separation. If there is conflicting traffic and ATC is unable to establish the required separation, ATC shall:

- a. Advise the pilot unable to issue clearance for requested deviation;
- b. Advise the pilot of conflicting traffic; and
- c. Request pilot's intentions.

PHRASEOLOGY—

UNABLE (requested deviation), TRAFFIC IS (call sign, position, altitude, direction), ADVISE INTENTIONS.

NOTE—

1. *The pilot will advise ATC of intentions by the most expeditious means available.*
2. *In the event that pilot/controller communications cannot be established or a revised ATC clearance is not available, pilots will follow the procedures outlined in the Regional Supplementary Procedures, ICAO Doc. 7030.*

Section 8. Caribbean ICAO Region

8-8-1. APPLICATION

Provide air traffic control services in the Caribbean ICAO Region with the procedures and minima contained in this section except when noted otherwise.

8-8-2. VERTICAL SEPARATION

Provide vertical separation in accordance with Chapter 4, IFR, Section 5, Altitude Assignment and Verification.

8-8-3. LONGITUDINAL SEPARATION

Provide longitudinal separation between aircraft as follows:

a. Supersonic flight:

1. *10 minutes* provided both aircraft are in level flight at the same Mach number or the aircraft are of the same type and are both operating in cruise climb, and one of the following;

(a) Both aircraft have reported over a common point; or,

(b) If both aircraft have not reported over a common point, the appropriate time interval being applied between aircraft exists and will exist at the common point; or,

(c) If a common point does not exist, the appropriate time interval being applied between aircraft exists and will exist at significant points along each track.

2. *15 minutes* between all other aircraft.

b. Turbojet operations above FL 200 in the Miami Oceanic, Houston Oceanic and San Juan CTAs/FIRs and all altitudes in the West Atlantic Route System (WATRS) and New York Oceanic CTA/FIR (*subsonic flight*):

1. Apply the prescribed minima in accordance with para 8-3-3, Mach Number Technique; or

2. In the New York CTA/FIR, where tracks diverge from the common point and the following

aircraft is maintaining a greater Mach number than the preceding aircraft:

(a) At least *10 minutes* longitudinal separation exists at the point where the tracks diverge; and

(b) At least *5 minutes* longitudinal separation will exist where minimum lateral separation is achieved (*whichever is estimated to occur first*);

(1) At or before the next significant point (normally within ten degrees of longitude along track(s)), or

(2) Within *90 minutes* of the time the following aircraft passes the common point, or

(3) Within *600 NM* of the common point; or

3. Apply *15 minutes* between all other turbojet aircraft.

c. Turbojet operations below FL 200 (*subsonic flight*):

Apply *20 minutes* between turbojet aircraft operating below FL 200 in the San Juan Oceanic (*outside the WATRS area*), Miami Oceanic and Houston Oceanic CTAs/FIRs.

d. Nonturbojet operations.

1. Apply *20 minutes* between aircraft operating in the WATRS; or

2. Apply *20 minutes* between aircraft operating below FL 200 in the Miami Oceanic, Houston Oceanic and San Juan CTAs/FIRs; or

3. Apply *30 minutes* between aircraft operating outside of the WATRS in the New York CTA/FIR.

NOTE-

The WATRS area is defined as beginning at a point 27°00'N/77°00'W direct to 20°00'N/67°00'W direct to 18°00'N/62°00'W direct to 18°00'N/60°00'W direct to 38°30'N/60°00'W direct to 38°30'N/69°15'W, thence counterclockwise along the New York Oceanic CTA/FIR boundary to the Miami Oceanic CTA/FIR boundary, thence southbound along the Miami Oceanic CTA/FIR boundary to the point of beginning.

8-8-4. LATERAL SEPARATION

Provide lateral separation by assigning different flight paths whose widths or protected airspace do not overlap. Apply the following:

a. 60 NM:

1. Supersonic aircraft operating above FL 275 within the New York oceanic CTA/FIR.

2. Supersonic aircraft operating at or above FL 450 not covered in subpara 1 above.

NOTE-

This reduced lateral separation shall not be used if track keeping capability of the aircraft has been reduced for any reason.

3. Aircraft which meet the MNPS and while operating in the New York oceanic CTA/FIR which are in transit to or from NAT MNPS airspace.

b. 90 NM between aircraft operating:

1. Within *WATRS*;

2. West of 55° West between the U.S., Canada, or Bermuda and points in the Caribbean ICAO Region.

c. 100 NM between aircraft operating west of 55° West not covered by subparas a or b above.

d. 120 NM between aircraft operating east of 55° West.

8-8-5. VFR CLIMB AND DESCENT

a. In the Houston, Miami, and San Juan CTAs, IFR flights may be cleared to climb and descend in VFR conditions only:

1. When requested by the pilot; and
2. Between sunrise and sunset.

b. Apply the following when the flight is cleared:

1. If there is a possibility that VFR conditions may become impractical, issue alternative instructions.

2. Issue traffic information to aircraft that are not separated in accordance with the minima in this section.

Section 9. Pacific ICAO Region

8-9-1. APPLICATION

Provide air traffic control services in the Pacific ICAO Region with the procedures and minima contained in this section except when noted otherwise.

8-9-2. VERTICAL SEPARATION

Provide vertical separation in accordance with Chapter 4, IFR, Section 5, Altitude Assignment and Verification, except when aircraft operate within airspace where composite separation and procedures are authorized, apply the minima specified in para 8-9-5, Composite Separation Minima.

8-9-3. LONGITUDINAL SEPARATION

In accordance with Chapter 8, Offshore/Oceanic Procedures, Section 3, Longitudinal Separation, apply the following:

a. Minima based on time:

1. 15 minutes between aircraft; or

2. The prescribed minima in accordance with para 8-3-3, Mach Number Technique.

b. Minima based on distance using Automatic Dependent Surveillance – Contract (ADS-C):

1. Apply the minima as specified in TBL 8-9-1, ADS-C Criteria, between aircraft on the same track within airspace designated for Required Navigation Performance (RNP), provided:

(a) Direct controller/pilot communication via voice or Controller Pilot Data Link Communications (CPDLC) is established, and

(b) The required ADS-C periodic reports are maintained and monitored by an automated flight data processor (e.g., Ocean21);

TBL 8-9-1

ADS-C Criteria

Minima	RNP	Maximum ADS-C Periodic Reporting Interval
50 NM	10	27 minutes
50 NM	4	32 minutes
30 NM	4	14 minutes

2. Aircraft on reciprocal tracks may be cleared to climb or descend to or through the altitude(s) occupied by another aircraft provided that:

(a) An ADS-C position report on at least one of the aircraft has been received beyond the passing point, and

(b) The aircraft have passed each other by the applicable separation minimum.

NOTE-

Ocean21 has been designed to check for the above criteria prior to allowing the minima to be provided.

3. When an ADS-C periodic or waypoint change event report is overdue by 3 minutes, the controller shall take action to obtain an ADS-C report.

4. If no report is received within 6 minutes of the time the original report was due, the controller shall take action to apply another form of separation.

c. Minima based on distance *without* ADS-C:

1. Apply 50 NM between aircraft cruising, climbing or descending on the same track or reciprocal track that meet the requirements for and are operating within airspace designated for RNP-10 operations provided:

(a) Direct controller/pilot communication via voice or CPDLC is maintained; and

(b) Separation is established by ensuring that at least 50 NM longitudinal separation minima exists between aircraft positions as reported by reference to the same waypoint.

(1) Same track aircraft – whenever possible ahead of both; or

(2) Reciprocal track aircraft – provided that it has been positively established that the aircraft have passed each other.

2. Distance verification shall be obtained from each aircraft at least every *24 minutes* to verify that separation is maintained.

3. If an aircraft fails to report its position within *3 minutes* after the expected time, the controller shall take action to establish communication. If communication is not established within *8 minutes* after the time the report should have been received, the controller shall take action to apply another form of separation.

NOTE—

When same track aircraft are at, or are expected to reduce to, the minima, speed control techniques should be applied in order to maintain the required separation.

d. Minima based on DME/RNAV:

Apply the following DME/RNAV minima in Control 1234H, Control 1487H and the Norton Sound High Control areas to turbojet aircraft established on or transitioning to the North Pacific (NOPAC) Route System.

1. *30 NM* between aircraft when DME reports or radar observations are used to verify the distance, otherwise at least *40 NM* based on RNAV must be applied; and

2. Both aircraft must provide DME/RNAV distance reports via direct voice that indicates the appropriate separation exists; and

3. Application of DME/RNAV separation without direct voice communications may not continue for more than *90 minutes*; and

4. The preceding aircraft is assigned the same or greater Mach number than the following aircraft; and

5. Both aircraft shall be advised of the other aircraft involved, including the distance relative to the flights.

EXAMPLE—

“Maintain Mach point eight four, same direction traffic, twelve o’clock, three five miles.”

REFERENCE—

FAAO 7110.65, Traffic Advisories, Para 2–1–21.

8–9–4. LATERAL SEPARATION

In accordance with Chapter 8, Offshore/Oceanic Procedures, Section 4, Lateral Separation, apply the following:

a. Within areas where Required Navigation Performance 10 (RNP–10) separation and procedures are authorized, apply *50 NM* to RNP–10 approved aircraft.

b. Apply *30 NM* to RNP–4 approved aircraft operating within airspace designated for RNP–4 when direct controller/pilot communications, via voice or Controller Pilot Data Link Communications (CPDLC), and the required ADS–C contracts are maintained and monitored by an automated flight data processor (e.g., Ocean21).

c. When aircraft operate within airspace where composite separation and procedures are authorized, apply the minimum specified in para 8–9–5, Composite Separation Minima.

d. Apply *100 NM* to aircraft not covered by subparas a, b or c.

8–9–5. COMPOSITE SEPARATION MINIMA

Provide composite separation within the Central East Pacific (CEP) and North Pacific (NOPAC) composite route systems and where designated by facility directive in the Pacific Organized Track System (PACOTS) at and above FL 290 as follows:

a. *1,000 feet* vertical separation; and

b. *50 NM* lateral separation.

8–9–6. COMPOSITE SEPARATION ALTITUDE ASSIGNMENT

a. Aircraft operating at or above FL 300 in a composite route system may be cleared at even flight levels. Additionally, aircraft may be cleared at even flight levels while joining, crossing, or leaving a composite route system provided such aircraft leaving the system are cleared to an appropriate odd cardinal flight level when noncomposite vertical or lateral separation is achieved.

b. Aircraft (operating at or above FL 300) leaving a composite route system at an even cardinal flight level do not have to be assigned an odd cardinal flight level provided:

1. The aircraft is being provided radar service; and

2. The aircraft will be cleared for descent and approach to an airport within the facility’s domestic FIR; and

3. There is an operational advantage.

c. Aircraft operating on unidirectional routes or traffic flows may be assigned altitudes other than the appropriate altitude for direction of flight provided that 2,000 feet vertical separation is maintained between aircraft operating on the same route.

8-9-7. COMPOSITE SEPARATION APPLICATION

Provide composite separation in the CEP and the North Pacific (NOPAC) composite route systems and where designated by facility directive in the Pacific Organized Track System (PACOTS) as follows:

a. Clear an aircraft to join an outer route of the composite route system at other than the normal entry point provided:

1. Longitudinal or noncomposite vertical separation exists between that aircraft and any other aircraft on that route; and

2. Composite separation exists between that aircraft and any other aircraft on the next adjacent route.

b. Clear an aircraft to leave an outer route of the composite route system at other than the normal exit point provided its course diverges so that lateral spacing from the route system increases until noncomposite separation exists between that aircraft and any other aircraft in the composite route system.

c. Clear an aircraft to change from one route to an adjacent route within the composite route system provided:

1. Longitudinal or noncomposite vertical separation is maintained between that aircraft and any other aircraft on the route being vacated until that aircraft is established on the route to which it is proceeding; and

2. Longitudinal or noncomposite vertical separation exists between that aircraft and any other aircraft on the route to which that aircraft is proceeding; and

3. Composite separation exists between that aircraft and any other aircraft on the next adjacent route.

d. Clear an aircraft to cross the composite route system provided longitudinal or noncomposite vertical or lateral separation exists between that

aircraft and any other aircraft in the composite route system.

e. Clear aircraft to transition to or from the composite route system from an Oceanic Transition Route (OTR) provided:

1. The OTR is charted on aeronautical charts; and

2. Composite separation is maintained between that aircraft and any other aircraft within the composite route system; and

NOTE-

An aircraft is within the confines of a composite route system when the aircraft joins or crosses the outer route of the composite route system or passes a composite route entry point.

3. Composite separation is maintained between that aircraft and any other aircraft on adjacent OTRs.

f. Clear an aircraft to change altitude on a route if noncomposite separation exists between that aircraft and others operating on that route regardless of other aircraft operating on adjacent routes in the system. Pilot's discretion climbs and descents are not authorized when applying composite separation.

NOTE-

Although composite separation is not applied between aircraft on different tracks at FL 280 and FL 290, this paragraph applies to climbs and descents between FL 280 and altitudes within the composite altitude stratum (FL 300 and above).

8-9-8. PROCEDURES FOR WEATHER DEVIATIONS AND OTHER CONTINGENCIES IN OCEANIC CONTROLLED AIRSPACE

Aircraft must request an ATC clearance to deviate. Since aircraft will not fly into known areas of weather, weather deviation requests should take priority over routine requests. If there is no traffic in the horizontal dimension, ATC shall issue clearance to deviate from track; or if there is conflicting traffic in the horizontal dimension, ATC separates aircraft by establishing vertical separation. If there is conflicting traffic and ATC is unable to establish standard separation, ATC shall:

a. Advise the pilot unable to issue clearance for requested deviation;

b. Advise the pilot of conflicting traffic; and

c. Request pilot's intentions.

PHRASEOLOGY-

UNABLE (requested deviation), TRAFFIC IS (call sign, position, altitude, direction), SAY INTENTIONS.

NOTE-

1. *The pilot will advise ATC of intentions by the most expeditious means available.*

2. *In the event that pilot/controller communications cannot be established or a revised AT clearance is not available, pilots will follow the procedures outlined in the Regional Supplementary Procedures, ICAO Doc 7030 and Chart Supplements.*

Section 10. North American ICAO Region– Arctic CTA

8–10–1. APPLICATION

Provide air traffic control services in the North American ICAO Region – Arctic CTA with the procedures and minima contained in this section.

8–10–2. VERTICAL SEPARATION

Provide vertical separation in accordance with:

- a. Chapter 4, IFR, Section 5, Altitude Assignment and Verification; and
- b. Facility directives depicting the transition between flight levels and metric altitudes.

8–10–3. LONGITUDINAL SEPARATION

In accordance with Chapter 8, Offshore/Oceanic Procedures, Section 3, Longitudinal Separation, apply the following:

- a. *15 minutes* between turbojet aircraft.
- b. The prescribed minima in accordance with para 8–3–3, Mach Number Technique.
- c. *20 minutes* between other aircraft.

8–10–4. LATERAL SEPARATION

In accordance with Chapter 8, Offshore/Oceanic Procedures, Section 4, Lateral Separation, apply the following:

- a. Provide *90 NM* lateral separation between aircraft, or
- b. Lower minima in para 5.4.1 of Chapter 5 of the Procedures for Air Navigation–Services, Air Traffic Management (PANS–ATM), (Doc 4444–ATM/501) may be applied or further reduced in accordance with para 5.11 of the same part where the conditions specified in the relevant PANS–ATM are met.

Chapter 9. Special Flights

Section 1. General

9-1-1. GENERAL

Provide aircraft engaged in the flight inspection of NAVAIDs with maximum assistance. Unless otherwise agreed to, maintain direct contact with the pilot and exchange information regarding known traffic in the area and his/her intentions.

NOTE-

1. Many flight inspections are accomplished using automatic recording equipment, and an uninterrupted flight is necessary for successful completion of the mission. The workload for the limited number of aircraft engaged in these activities requires strict adherence to a schedule.

2. Flight inspection operations which require special participation of ground personnel, specific communications, or radar operation capabilities are considered to require special handling. These flights are coordinated with appropriate facilities before departure.

REFERENCE-

FAAO 8200.1, *United States Standard Flight Inspection Manual*.
FAAO 8240.41, *Flight Inspection/Air Traffic On-Site Coordination Requirements*.

9-1-2. SPECIAL HANDLING

a. Clear the aircraft according to pilot request as soon as practicable. Do not ask the pilot to deviate from his/her planned action except to preclude an emergency situation.

REFERENCE-

FAAO 8240.41, *Flight Inspection/Air Traffic On-Site Coordination Requirements, Appendix 1, describes certain flight inspection maneuvers in detail*.

b. Issue radar advisories to the flight inspection aircraft where adequate coverage exists and to the extent permitted by workload.

c. Suggest flight path adjustments, as required, for any aircraft which will enter or penetrate an area in which a flight inspection function is being performed.

d. Provide special handling, as required, to FAA aircraft conducting flight inspections using the call sign "Flight Check." The call sign "Flight Check (Nr) recorded" indicates automated flight inspections are in progress in terminal areas.

NOTE-

FAA flight inspection aircraft will file flight plans using the call sign "FLIGHT CHECK" during flight inspections or when inbound to conduct flight inspections. Flight plan remarks may indicate type NAVAID inspection to be accomplished; e.g. "FC OKC P."

9-1-3. FLIGHT CHECK AIRCRAFT

a. Provide special handling, as required, to expedite flight inspection of NAVAIDs, direction finding (DF) equipment, and RADAR by flight check aircraft.

NOTE-

Certain flight inspection maneuvers require operations in close proximity to the surface. These maneuvers can only be performed during daylight visual meteorological conditions. Preplanned automatic flight places the following limitations on the capability of the pilot to adhere to normal ATC clearances:

a. Route of flight – orbital from 6 nautical miles to a maximum of 40 nautical miles from the facility depending on the type of inspection. During commissioning flight checks all DPs, STARs, airways, DME fixes, and approaches must be flown.

b. Altitude assignment – from 1,000 feet above the antenna site up to the minimum en route altitude (MEA).

REFERENCE-

FAAO 7110.65, *Operational Priority, Para 2-1-4*
FAAO 8240.41, *Flight Inspection/Air Traffic On-Site Coordination Requirements, Appendix 1, describes certain flight inspection maneuvers in detail*.

b. Avoid changes in the route or altitude from that filed by the pilot in the initial flight plan.

c. Do not impose air traffic control delays in the flight except to preclude emergency situations.

d. Do not change the previously assigned discrete beacon code of special radar accuracy flight check aircraft.

REFERENCE-

FAAO 7210.3, *Special Radar Accuracy Checks, Para 7-1-3*.
FAAO 7210.3, *ASR Performance Checks, Para 10-5-4*.

Section 2. Special Interest Flights

9-2-1. GENERAL

EN ROUTE

a. All flight movement data on the aircraft listed in subparas 1 and 2 below shall be immediately brought to the attention of the supervisory traffic management coordinator-in-charge and forwarded by the most expeditious means (voice, if possible) to the senior director at the concerned NORAD Region Operations Control Center/Sector Operations Control Center and to the Air Traffic Control System Command Center (ATCSCC). Voice messages will be followed up with a data communication message when directed. All flight plans on aircraft listed in subparas 1 and 2 below, including flights within the continental U.S., shall be retransmitted by data communication to ATT-200 and the Office of International Aviation, attention: AIA-101.

NOTE-

1. All flight movement data includes flight plans and changes thereto such as changes from IFR to VFR, reroutes or route deviations authorized or directed by the facility, departure messages, arrival messages, unauthorized route deviations or any other unusual operations, etc.

2. These procedures are in addition to the AMIS procedures contained in FAAO 7610.4, Special Military Operations, Chapter 5, Aircraft Movement Information Service (AMIS).

3. The concerned NORAD region/sector is the one to whom SCATANA reports are forwarded consistent with local ARTCC/NORAD REGION SCATANA REPORTING PROCEDURES.

4. All continental U.S. facilities have either direct flow control interphone circuits or can reach ATT-200 by DSN, 725-3333, or telephone (703) 708-5100.

1. All known aircraft of Cuban registry and all known civil aircraft of other special interest countries that will enter, overfly, or operate within the continental U.S., the Atlantic, Gulf of Mexico or Pacific Coastal ADIZs, or the Southern Border Domestic ADIZ.

NOTE-

Special interest countries include Albania, Bulgaria, Cambodia, Peoples Republic of China, Cuba, North Korea, Outer Mongolia, Romania, Russia, the Ukraine, and other members of the Commonwealth of Independent States, and Socialist Republic of Vietnam.

REFERENCE-

P/CG Term- Continental United States.

2. All known civil aircraft of foreign registry, other than the aircraft in subpara 1, that will enter or overfly the continental U.S. en route to or from Cuba.

b. Advance route information which has been cleared by NORAD and coordinated by AIA-101 with the State Department, as necessary, will be passed to the concerned ARTCCs by AIA-101 via ATT-200. Inform ATT-200 of your concurrence or problems with the route, as the case may be. ATT-200 will relay any problems to AIA-101 for resolution with NORAD. Advance route information does not constitute the forwarding of flight movement data to NORAD as specified in subpara a.

REFERENCE-

FAAO 7110.65, Application, Para 9-2-2

9-2-2. APPLICATION

EN ROUTE

a. Comply with any operational request that may be received directly from NORAD or through ATT-200 unless the change will affect flight safety. When safety is a factor, acquaint NORAD with the situation and attempt to work out an alternate solution if time and circumstances permit. If unable, take the course of action dictated by flight safety considerations and inform NORAD and ATT-200 as quickly as possible thereafter. Comply with requests for information or assistance from NORAD or the State Department which may include relay of messages to facilities or an aircraft in flight.

NOTE-

State Department communications will be relayed through ATT-200.

b. Request the aircraft to return to its approved route/reroute of flight whenever any deviation is noted.

c. Immediately alert the supervisory traffic management coordinator-in-charge and notify the senior director at the concerned NORAD Region Operations Control Center/Sector Operations Control Center and ATT-200 via the most expeditious means when the following conditions occur:

1. The aircraft refuses to comply with a NORAD or State Department message.
2. Communication with the aircraft is established but the aircraft's identification cannot be immediately correlated with a known flight plan. Attempt flight plan correlation when time permits.
3. The aircraft deviates from its approved route of flight and refuses to return to it when so requested.
4. The aircraft refuses a reroute when so cleared or deviates from its reroute and refuses to return to it when requested.
5. A departure message on a flight plan of an aircraft in para 9-2-1, General, subpara a1 originating in Canada, Mexico, or Cuba is not received within 5 minutes after the proposed time and you are unable to ascertain if the aircraft has departed either IFR or VFR.

d. If NORAD dispatches aircraft to intercept and escort the flight, the control procedures in FAAO 7610.4, Special Military Operations, Chapter 7, Escort of Hijacked Aircraft, shall apply.

9-2-3. EMERGENCY OR UNSCHEDULED LANDINGS

a. If an aircraft of a special interest country makes an emergency or unscheduled landing in the U.S., immediately alert the supervisory traffic management coordinator-in-charge/controller-in-charge of the shift and notify:

1. *EN ROUTE*. In the Continental U.S.–

(a) The senior director at the concerned NORAD Region Operations Control/Sector Operations Control Center.

(b) ATT-200.

NOTE–

ATT-200 will relay or voice-patch the information to all FAA Washington Headquarters organizations concerned.

(c) U.S. Customs Service Office for the airport where the aircraft will land.

2. *EN ROUTE*. In the Pacific Region, Puerto Rico, and the Virgin Islands– The Air Defense Control Center and the offices specified in subparas a1(b) and (c).

NOTE–

Guam CERAP forwards the information through the Honolulu ARTCC.

3. *EN ROUTE*. In the Alaskan Region– The Alaskan NORAD Region Operations Control Center and the offices specified in subparas a1(b) and (c).

4. *TERMINAL*. The nearest U.S. Customs Service Office and the appropriate ARTCC.

b. Provide the following information to the organizations specified in subpara a1(a) if available:

1. Type of aircraft.
2. Country of aircraft registry.
3. Destination airport.
4. Nature of emergency or reason for landing, as appropriate.

c. Advise the pilot that passengers must remain aboard the aircraft after landing until cleared by the U.S. Customs Service Office.

d. *TERMINAL*. In cases where communication is established with the aircraft but the aircraft identification cannot be immediately correlated with a known flight plan, notify the appropriate ARTCC and nearest U.S. Customs Service Office.

Section 3. Special Operations

9-3-1. AIRCRAFT CARRYING DANGEROUS MATERIALS

a. Provide the following special handling to military aircraft or military contracted aircraft carrying dangerous materials when:

1. The words “dangerous cargo,” or “inert devices,” or both are contained in the remarks section of the filed flight plan, or

NOTE-

1. *Certain types of military flights carrying dangerous materials require strict adherence to military regulations and flight planning along carefully selected routes. These flights must avoid heavily populated areas.*

2. *“Inert devices” are devices containing no dangerous materials but closely resembling nuclear or explosive items that are classified as dangerous and could be easily mistaken for their dangerous counterparts.*

2. The pilot uses these words in radio communication.

b. If it becomes necessary to issue a clearance to amend the route/altitude, advise the pilot:

1. Of the proposed change, and

2. The amount of delay to expect if it is necessary to maintain the present route/altitude.

c. When it becomes necessary for the pilot to refuse a clearance amending his/her route/altitude, he/she will advise if the traffic delay is acceptable or if an alternate route/altitude is desired. In such cases, offer all possible assistance.

d. When the aircraft is provided an en route descent, do not vector the aircraft from the planned route unless the pilot concurs.

e. Use special patterns and routings in areas where they have been developed for these flights. If special patterns and routings have not been developed, employ normal procedures.

9-3-2. CELESTIAL NAVIGATION TRAINING

EN ROUTE

a. Approve flight plans specifying celestial navigation only when it is requested for USAF or USN aircraft.

NOTE-

An ATC clearance must be obtained by the pilot before discontinuing conventional navigation to begin celestial navigation training. The pilot will advise when discontinuing celestial navigation and resuming conventional navigation. Celestial navigation training will be conducted within 30 NM of the route centerline specified in the en route clearance unless otherwise authorized by ATC. During celestial navigation training, the pilot will advise ATC before initiating any heading changes which exceed 20 degrees.

b. Within conterminous U.S. airspace, limit celestial navigation training to transponder-equipped aircraft within areas of ARTCC radar coverage.

c. Prior to control transfer, ensure that the receiving controller is informed of the nature of the celestial navigation training leg.

REFERENCE-

FAAO 7110.65, IFR Flight Progress Data, Para 2-2-6

9-3-3. DEPARTMENT OF ENERGY (DOE) SPECIAL FLIGHTS

a. Provide notification of possible route or altitude changes as far in advance as possible for “RAC” flights. The pilot will indicate if the proposed change is acceptable or if alternate routing or altitude will be requested.

NOTE-

DOE contracts for civil pilots to operate public aircraft to transport radioactive or high explosive materials within the conterminous U.S. These flights operate on an IFR flight plan but principally during daylight hours and VFR conditions. These flights require flight along carefully selected routes and, in some instances, pilots will refuse clearances that require reroute or altitude changes that would derogate their objective.

b. *EN ROUTE.* Approve pilot requests to leave center frequency for operational purposes as traffic conditions permit.

c. Notify a supervisor in the event any of the following occurs with “RAC” aircraft:

1. Loss of radio contact.

2. Loss of radar contact.

3. The flight is overdue at the destination.

d. If you receive information that a “RAC” aircraft is involved in an accident, secure as much information as possible, particularly with respect to location, and immediately notify the ARTCC supervisory traffic management coordinator-in-charge.

NOTE-

There is a possibility of an explosive or radiation hazard of an “RAC” aircraft involved in an accident.

9-3-4. EXPERIMENTAL AIRCRAFT OPERATIONS

a. When notified that an experimental aircraft requires special handling:

NOTE-

14 CFR Section 91.319(d)(3) requires that each person operating an aircraft with an experimental certificate shall notify the control tower of the experimental nature of the aircraft when operating into or out of airports with operating control towers.

1. Clear the aircraft according to pilot requests as traffic permits and if not contrary to ATC procedures.

2. Once approved, do not ask the pilot to deviate from a planned action except to preclude an emergency situation.

b. At locations where volume or complexity of experimental aircraft operations warrant, a letter of agreement may be consummated between the facility and operator.

9-3-5. FAA RESEARCH AND DEVELOPMENT FLIGHTS

When coordinated in advance and traffic permits, approve requests for special flight procedures from aircraft participating in FAA research and development test activities. These special procedures shall be applied to participating aircraft/vehicles.

NOTE-

Special flight procedures for FAA research and development test activities must be approved by the facility air traffic manager prior to their use.

REFERENCE-

FAAO 7210.3, Research and Development Flights, Para 5-2-4.

9-3-6. FLYNET

Provide expeditious handling for U.S. Government, civil or military aircraft using the code name “FLYNET.” Relay the code name as an element in the remarks position of the flight plan.

NOTE-

The code name “FLYNET” indicates that an aircraft is transporting a nuclear emergency team or a disaster control team to the location of a potential or actual nuclear accident or an accident involving chemical agents or hazardous materials. It is in the public interest that they reach their destination as rapidly as possible.

REFERENCE-

FAAO 7110.65, Operational Priority, Para 2-1-4

FAAO 7610.4, “FLYNET” Flights, Nuclear Emergency Teams, Para 12-4-1.

9-3-7. IFR MILITARY TRAINING ROUTES

a. Except for aircraft operating in the same altitude reservation, clear aircraft into an MTR provided separation will be applied between successive aircraft unless otherwise covered in a letter of agreement between the military scheduling activity and the concerned ATC facility.

PHRASEOLOGY-

CLEARED INTO IR (designator).

MAINTAIN (altitude),

or

MAINTAIN IR (designator) ALTITUDE(S),

or

MAINTAIN AT OR BELOW (altitude),

or

CRUISE (altitude),

and if required,

CROSS (fix) AT OR LATER THAN (time).

b. Unless otherwise covered in a letter of agreement between the military scheduling activity and the concerned FAA facility, clear aircraft to exit an MTR.

PHRASEOLOGY-

CLEARED TO (destination/clearance limit) FROM IR (designator/exit fix) VIA (route).

MAINTAIN (altitude).

c. If the provisions of subpara a above cannot be accomplished, MTRs may be designated for MARSAs operations. To preclude an inadvertent compromise of MARSAs standards by ATC, appropriate MARSAs application for such routes shall be covered in a letter of agreement with the military scheduling activity. Establish separation between aircraft as soon as practicable after operation on the designated MARSAs route is ended.

NOTE-

For designated MARSAs routes, the military assumes responsibility for separation for MTR aircraft that have passed the primary/alternate entry fix until separation is established by ATC after operations on the MARSAs route are completed.

d. The lateral airspace to be protected along an MTR is the designated width of the route.

e. Prior to an aircraft entering an MTR, request the pilot's estimate for the route's exit/alternate exit fix, the pilot's requested altitude after exiting and, if applicable, the number of reentries on a Strategic Training Range (STR).

PHRASEOLOGY-

(Call sign) CONFIRM YOUR EXIT FIX ESTIMATE AND REQUESTED ALTITUDE AFTER EXIT,

and if applicable,

THE NUMBER OF REENTRIES.

f. Forward estimates for exit/alternate exit fixes, requested altitude after exit, and, if applicable, the number of reentries on the STR.

g. Apply the procedures of para 6-1-2, Nonreceipt of Position Report, based upon the pilot's estimate for the route exit fix.

h. Clearance may be issued to amend or restrict operations on a route for ATC considerations. Where a route has been designated MARSAs in accordance with subpara c, ATC shall not amend or restrict operations in such a manner as to compromise MARSAs provisions.

NOTE-

When MARSAs is provided through route scheduling and circumstances prevent the pilot from entering the route within established time limits, it shall be the responsibility of the pilot to inform the ATC facility and advise his/her intentions.

i. If an aircraft on an IR experiences a two-way radio communications failure and you are unable to determine if the aircraft is proceeding VFR in accordance with 14 CFR Section 91.185(b) or the aircraft has not been positively radar identified:

1. Provide separation to the destination airport based on the aircraft complying with the following:

(a) Maintain to the exit/alternate exit fix the higher of the following altitudes:

(1) The minimum IFR altitude for each of the remaining route segment(s) remaining on the route.

(2) The highest altitude assigned in the last ATC clearance.

(b) Depart the exit/alternate exit fix at the appropriate altitude specified in subpara (a) above, then climb/descend to the altitude filed in the flight plan for the remainder of the flight, or

NOTE-

In the event of a two-way communications failure, ATC will be based on the following anticipated pilot action at the exit fix. Unless otherwise covered in a letter of agreement, and if the pilot is unable to comply with the VFR provisions of 14 CFR Section 91.185/FLIP IFR Supplement, the pilot will exercise his/her emergency authority, squawk transponder Code 7700, depart the exit/alternate exit fix and climb/descend (continuing to squawk 7700) to the altitude filed in the flight plan. Subsequent transponder operations will be in accordance with para 10-4-4 Communications Failure. Air traffic controller action from the exit fix is as prescribed in para 10-1-4 Emergency Determinations.

(c) Proceed in accordance with the lost communication procedure contained in letters of agreement.

2. Continue to monitor the last ATC assigned discrete code.

NOTE-

Pilots who experience a two-way radio failure will adjust their transponder to Code 7700 during climb/descent to altitude filed for the next leg of the flight plan; then change to Code 7600 for a period of 15 minutes. At the end of each 15-minute period, he/she will squawk 7700 for a period of 1 minute; all other times he/she will squawk 7600.

j. Impose delays, if needed, to eliminate conflict with nonparticipating IFR aircraft when necessary to preclude denial of IR usage. Advise the pilot of the expected length and reason for delay.

9-3-8. INTERCEPTOR OPERATIONS

Provide maximum assistance to expedite the movement of interceptor aircraft on active air defense (scrambles) missions until the unknown aircraft is identified in accordance with the policies and procedures published in FAAO 7610.4, Special Military Operations.

NOTE-

The FAA and the military have mutually agreed to the implementation of policies and procedures for control of air defense interceptor operations. Effective coordination and cooperation between FAA and the military at all levels are essential if policy objectives are to be met.

- a. The ADCF initiating the SCRAMBLE shall identify the mission as an active air defense mission.
- b. ATC services shall be used for active air defense missions insofar as the circumstances and situation permits.
- c. Upon request, the ATC facility shall expedite transfer of the control jurisdiction of the interceptors to the requesting ADCF.

9-3-9. SPECIAL INTEREST SITES

- a. Relay immediately to supervisory/CIC personnel any reports or information regarding unusual aircraft activities in the vicinity of special interest sites such as nuclear power plants, power plants, dams, refineries, etc. Supervisory/CIC personnel may also receive reports/information from the Nuclear Regulatory Commission or other sources.
- b. Supervisory/CIC personnel shall immediately notify local law enforcement authorities of these reports/information as well as notifying the overlying air traffic facility of any of these reports and the action taken.
- c. ARTCCs shall promptly advise the ATCSCC of any actions taken in accordance with this paragraph.

9-3-10. LAND-BASED AIR DEFENSE IDENTIFICATION ZONE (ADIZ) ATC PROCEDURES**TERMINAL**

- a. Verify IFR and VFR flight operations entering, exiting, or transitioning the ADIZ meet all of the following minimum conditions:

1. Two-way radio communications are maintained at all times prior to entering and throughout transition of the ADIZ. Aircraft operating in an airport traffic pattern or landing at nontowered airports are exempt from the ATC communication requirement, provided they monitor the airport common traffic advisory frequency.

2. Aircraft is equipped with an operating transponder with automatic altitude reporting capability. Aircraft is squawking an ATC assigned discrete beacon code at all times. Do not allow an aircraft to cancel its flight plan and/or squawk VFR while in the ADIZ.

3. Aircraft flying too low for radar coverage shall be instructed to report landing or exiting the ADIZ. Maintain flight progress strips on such aircraft until pilot reports landing or exiting the ADIZ. If a flight progress strip does not exist for the aircraft, record the call sign, transponder code, entry point (e.g., north, northeast, east), and time of entry into the ADIZ.

PHRASEOLOGY-

(Call sign), REPORT LANDING OR LEAVING THE ADIZ.

4. United States Military, law enforcement, and aeromedical flights are exempt from filing flight plans.

- b. Pilots unable to comply with the requirements of subpara a, above, shall be advised to remain clear of the ADIZ.

9-3-11. LAW ENFORCEMENT OPERATIONS BY CIVIL AND MILITARY ORGANIZATIONS

- a. Law enforcement alerts.

1. Aircraft lookouts shall not be distributed outside the FAA.

REFERENCE-

*FAAO 1600.29, Law Enforcement Alert Message System.
FAAO 7210.3, Cooperation With Law Enforcement Agencies, Para 2-7-7.*

2. Stolen aircraft alerts, including stolen aircraft summaries, may be distributed outside the FAA to: airport offices, air carriers, fixed base operators, and law enforcement agencies.

3. Upon receipt of knowledge concerning an aircraft for which a current law enforcement alert message is held, do the following:

(a) Forward any information on the aircraft to El Paso Intelligence Center (EPIC) and the requester when specified in the message.

(b) Immediately notify the cognizant Air Transportation Security division/staff by the most rapid means.

(c) DO NOT TAKE ANY OTHER ACTION AFFECTING THE AIRCRAFT, CARGO, CREW, OR PASSENGERS NOT NORMALLY RELATED TO JOB RESPONSIBILITIES.

b. Special law enforcement operations.

1. Special law enforcement operations include inflight identification, surveillance, interdiction and pursuit activities performed in accordance with official civil and/or military mission responsibilities.

2. To facilitate accomplishment of these special missions, exemptions from specified parts of Title 14 of the Code of Federal Regulations have been granted to designated departments and agencies. However, it is each organization's responsibility to apprise ATC of their intent to operate under an authorized exemption before initiating actual operations.

REFERENCE-

FAAO 7210.3, *Authorizations and Exemptions from Title 14, Code of Federal Regulations (14 CFR), Para 18-3-1.*

3. Additionally, some departments and agencies that perform special missions have been assigned coded identifiers to permit them to apprise ATC of ongoing mission activities and solicit special air traffic assistance.

REFERENCE-

FAAO 7110.67, *Special Aircraft Operations by Law Enforcement/Military Organizations.*

NOTE-

As specified in para 2-1-4 *Operational Priority*, priority of handling for aircraft operating with coded identifiers will be the same as that afforded to SAR aircraft performing a SAR mission.

c. Assistance to law enforcement aircraft operations.

1. Provide the maximum assistance possible to law enforcement aircraft, when requested, in helping them locate suspect aircraft.

2. Communicate with law enforcement aircraft, when possible and if requested, on a frequency not paired with your normal communications frequencies.

3. Do not allow assistance to law enforcement aircraft to violate any required separation minima.

4. Do not assist VFR law enforcement aircraft in any way that will create a situation which, in your judgement, places the aircraft in unsafe proximity to terrain or other aircraft.

9-3-12. MILITARY AERIAL REFUELING

Authorize aircraft to conduct aerial refueling along published or special tracks at their flight plan altitude, unless otherwise requested.

PHRASEOLOGY-

CLEARED TO CONDUCT REFUELING ALONG (number) TRACK,

or

FROM (fix) TO (fix),

and

MAINTAIN REFUELING LEVEL (altitude),

or

MAINTAIN (altitude),

or

COMMENCING AT (altitude), DESCENDING TO (altitude).

NOTE-

1. During aerial refueling, tanker aircraft are responsible for receiver aircraft communication with ATC and for their navigation along the track.

2. Aerial refueling airspace is not sterilized airspace and other aircraft may transit this airspace provided vertical or lateral separation is provided from refueling aircraft.

3. MARSAs begins between the tanker and receiver when the tanker and receiver(s) have entered the air refueling airspace and the tanker advises ATC that he/she is accepting MARSAs.

4. MARSAs ends between the tanker and receiver when the tanker advises ATC that the tanker and receiver aircraft are vertically positioned within the air refueling airspace and ATC advises MARSAs is terminated.

REFERENCE-

FAAO 7110.65, *Use of MARSAs, Para 2-1-1.*

FAAO 7110.65, *Additional Separation for Formation Flights, Para 5-5-8*

FAAO 7610.4, *Chapter 10, Aerial Refueling.*

a. Provide radar assistance to the rendezvous for participating aircraft:

1. When requested, and

2. By providing vertical separation prior to MARSAs declaration.

b. Do not request receiver aircraft that have been cleared to conduct air refueling and have departed the ARIP to:

1. Make code changes when less than 5 miles from the tanker.

2. Squawk standby when less than 1 mile or more than 3 miles from the tanker.

NOTE-

Requests for receiver aircraft to make code changes during air refueling diverts the receiver pilot's attention during a critical phase of flight.

c. When issuing an initial air refueling clearance, you may request a receiver to squawk standby when the receiver reaches a point 3 miles from the tanker.

NOTE-

1. Receiver aircraft will squawk normal when separation from the tanker is greater than 3 miles.

2. Once rendezvous is completed, heading and altitude assignments may be made with the tanker concurrence with MARSAs remaining in effect.

3. Upon rendezvous completion, the tanker shall keep receiver aircraft within 3 miles of the tanker until MARSAs is terminated.

d. After MARSAs has been declared, you should avoid issuing course or altitude changes prior to rendezvous.

NOTE-

Altitude or course changes issued will automatically void MARSAs.

e. Do not use the altitude vacated during the refueling operation until the refueling aircraft has reported reaching the next IFR altitude.

REFERENCE-

FAAO 7110.65, *Exceptions, Para 6-6-2*

f. Approve requests by the tanker pilot for vectors or alternative routes or altitudes as follows:

1. Furnish vectors or alternative altitudes at any time.

2. Furnish nonradar routes only after the refueling aircraft have passed the ARCP.

NOTE-

1. *To meet a training requirement that aerial refueling be accomplished in a nonradar environment, the military has requested that vectors be furnished only upon request.*

2. *The tanker commander is responsible for coordinating all inflight requests with other aircraft in the refueling mission before submission of such requests to the center.*

3. *Normally, aircraft conducting aerial refueling operations will utilize at least three consecutive altitudes.*

g. Unless a vector or alternative route has been furnished, clear the aircraft to depart the refueling track at a navigational reference point or egress fix.

h. Request an aircraft to report the ARIP, ARCP, or egress fix as necessary.

PHRASEOLOGY-
REPORT:

A-R-I-P

or

A-R-C-P

or

EGRESS FIX.

i. Expect the following procedures in addition to those required by the appropriate parts of Title 14 of the Code of Federal Regulations in the event of two-way communications failure:

1. The tanker will depart the track from the highest altitude in the block.

2. The receiver will depart the track from the lowest altitude in the block.

3. Aircraft will squawk 7600 for at least 2 minutes prior to departing the track.

REFERENCE-

FAAO 7110.65, *Military Operations Above FL 600, Para 9-3-13* ■

9-3-13. MILITARY OPERATIONS ABOVE FL 600

Control aircraft operating above FL 600 using the following procedures:

a. Flight plans involving supersonic flight are required 16 hours in advance of proposed departure times for processing and approval by the ARTCCs concerned. The originating ARTCC, where the flight plan is first filed, may waive the 16 hour advance filing requirement.

b. The route of flight shall be defined by at least one high altitude fix within each ARTCC area without regard to the distance between fixes. Additionally, the entry and exit points of turns of 90 degrees or more will be designated.

c. Elapsed times from takeoff to the first fix in each ARTCC area shall be included in the route of flight.

d. The ARTCC which originates the flight plan shall forward departure times to all ARTCCs responsible for processing the flight plan.

e. Approval of the flight plan indicates approval of both route and FLs (if stated) including operations below FL 600 (aerial refueling).

PHRASEOLOGY-

CLEARED AS FILED VIA ROUTE AND FLIGHT LEVELS.

REFERENCE-

FAAO 7110.65, Military Aerial Refueling, Para 9-3-12

f. Separation. Use the following as minima in lieu of the corresponding type of separation prescribed in:

NOTE-

The primary method described to provide separation between two supersonic aircraft is to descend the aircraft at the lower FL and provide vertical separation since the aircraft at the higher FL may not be able to climb rapidly enough to establish the required separation. Another aspect which should be considered is that supersonic aircraft during turns, either programmed or as the result of vectors, will lose a few thousand feet. Vectoring supersonic aircraft seriously affects the range and mission objectives. Radar separation is the preferred method of separating a subsonic aircraft both from another subsonic aircraft or from a supersonic aircraft.

1. Para 4-5-1, Vertical Separation Minima: 5,000 feet.

NOTE-

1. The security requirements of the military services preclude the transmission of actual altitude information on the air/ground or landline circuits. A classified document detailing the plan for ascertaining altitude codes for the day should be readily available to the controllers at their positions of operation.

2. Pilots will report their altitude, using the coded plan, and intended flight profile on initial contact with each ARTCC.

2. Para 6-5-4, Minima Along Other Than Established Airways or Routes: Protect the airspace 25 miles either side of the route centerline. For turns by supersonic aircraft, protect the airspace 75 miles on the overflowed side and 25 miles on the other side. For turns by subsonic aircraft, protect the airspace 34 miles on the overflowed side and 25 miles on the other side.

REFERENCE-

FAAO 7110.65, Abbreviated Departure Clearance, Para 4-3-3

9-3-14. MILITARY SPECIAL USE FREQUENCIES

a. Assign special use frequency to:

NOTE-

Special use frequencies are assigned to ARTCCs in such a manner that adjacent ARTCCs will not have the same frequency. They are to be used within the ARTCC area jurisdiction from the established FL base of the high altitude sectors and above. Each high altitude sector should have the capability to use the special use frequency on a shared basis.

1. USAF, U.S. Navy, and Air National Guard (ANG) single-pilot jet aircraft formations operating at night or in instrument weather conditions. Formations of five or more USAF aircraft deploying either to a continental U.S. staging base or nonstop to an overseas location are authorized to use special use frequencies at any time. Normally these deployments will be conducted within an altitude reservation.

2. U-2 and B-57 (pressure suit flights) aircraft at all altitudes/FLs except where terminal operations require the assignment of other frequencies.

NOTE-

Aerial refueling operations may require that aircraft leave the special use frequency for communications with the tanker. This will occur when the receiver is approximately 200 miles from the ARCP. The tanker aircraft will remain on the ARTCC assigned frequency and will relay clearances to the receiver as required. An alternate means of communications between the tanker and receiver is HF radio.

3. All aircraft during supersonic flight.

NOTE-

Pilots are expected to request assignment of the special use frequency in the remarks section of the flight plan or before entering supersonic flight. B-57 aircraft engaged in pressure suit operations will use the static call sign KITE and flights will normally be conducted from Dover, Eielson, Ellington, Hickman, Howard, Kirtland, and McClellan Air Force Bases.

4. E-3A AWACS mission crews when operations are being conducted as an MRU in accordance with appropriate letters of agreement.

b. The special use frequency may be assigned as “backup” for the high-altitude sector when direct communications are essential because of a potential emergency control situation.

c. Do not assign the special use frequency to the aircraft in subpara a1 above, when they will operate in airspace assigned for special military operations.

9-3-15. AVOIDANCE OF AREAS OF NUCLEAR RADIATION

a. Advise pilots whenever their proposed flight path will traverse a reported or forecasted area of hazardous radiation and reroute the aircraft when requested by the pilot.

REFERENCE-

FAAO 7610.4, Avoidance of Hazardous Radiation Areas, Para 4-4-4.

b. Inform pilots when an airfield of intended landing lies within a reported or forecasted area of hazardous radiation and request the pilot to advise his/her intentions.

9-3-16. SAMP

Provide special handling to U.S. Government and military aircraft engaged in aerial sampling missions (atmosphere sampling for nuclear, chemical, or hazardous material contamination). Honor inflight clearance requests for altitude and route changes to the maximum extent possible. Other IFR aircraft may be recleared so that requests by SAMPLER aircraft are honored. Separation standards as outlined in this order shall be applied in all cases.

REFERENCE-

FAAO 7110.65, Operational Priority, Para 2-1-4

FAAO 7110.65, Aircraft Identification, Para 2-4-20

FAAO 7610.4, Avoidance of Hazardous Radiation Areas, Para 4-4-4.

9-3-17. AWACS/NORAD SPECIAL FLIGHTS

Do not delay E-3 AWACS aircraft identified as “AWACS/NORAD Special” flights. The following control actions are acceptable while expediting these aircraft to the destination orbit.

a. En route altitude changes +/- 2,000 feet from the requested flight level.

b. Radar vectors or minor route changes that do not impede progress towards the destination orbit.

NOTE-

NORAD has a requirement to position E-3 AWACS aircraft at selected locations on a time-critical basis. To the extent possible these flights will utilize routes to the destination orbit that have been precoordinated with the impacted ATC facilities. To identify these flights, the words “AWACS/NORAD SPECIAL” will be included as the first item in the remarks section of the flight plan.

9-3-18. WEATHER RECONNAISSANCE FLIGHTS

TEAL and NOAA mission aircraft fly reconnaissance flights to gather meteorological data on winter storms, (NWSOP missions), hurricanes and tropical cyclones (NHOP missions). The routes and timing of these flights are determined by movement of the storm areas and not by traffic flows.

a. When a dropsonde release time is received from a TEAL or NOAA mission aircraft, workload and priorities permitting, controllers shall advise the mission aircraft of any traffic estimated to pass through the area of the drop at altitudes below that of the mission aircraft. This traffic advisory shall include:

1. Altitude.

2. Direction of flight.

3. ETA at the point closest to drop area (or at the fix/intersection where drop will occur).

NOTE-

A dropsonde is a 14-inch long cardboard cylinder about 2.75 inches in diameter, that weighs approximately 14 ounces (400 grams), and has a parachute attached. When released from the aircraft it will fall at a rate of approximately 2,500 feet per minute. Controllers should recognize that a dropsonde released at FL 310 will be a factor for traffic at FL 210 four minutes later. It is the aircraft commanders responsibility to delay release of dropsondes if traffic is a factor. Aircraft commanders will delay release of dropsondes based solely upon traffic as issued by ATC.

b. When advised that an airborne TEAL or NOAA aircraft is requesting a clearance via CARCAH, issue the clearance in accordance with Chapter 4, IFR, Section 2, Clearances.

REFERENCE–

FAAO 7110.65, *Clearance Items, Para 4–2–1*
FAAO 7110.65, *Clearance Prefix, Para 4–2–2*
FAAO 7110.65, *Delivery Instructions, Para 4–2–3*

c. If a TEAL or NOAA mission aircraft must be contacted but is out of VHF, UHF, and HF radio range, advise the supervisory traffic management coordinator-in-charge.

REFERENCE–

FAAO 7210.3, *Weather Reconnaissance Flights, Para 5–3–6.*
FAAO 7110.65, *Operational Priority, Para 2–1–4*

9–3–19. EVASIVE ACTION MANEUVER

Approve a pilot request to conduct an evasive action maneuver only on the basis of a permissible traffic situation. Specify the following items, as necessary, when issuing approval:

NOTE–

The “evasive action” maneuver is performed by a bomber/fighter bomber aircraft at or above FL 250 along a 60 NM long segment of the flight plan route overlying a RBS or other site and includes:

1. Flying a zigzag pattern on both the left and right side of the flight plan route centerline. Altitude deviations are made in conjunction with the lateral maneuvering.
2. Lateral deviations from the route centerline will not normally exceed 12 miles. Altitude variations shall not exceed plus or minus 1,000 feet of the assigned flight level; i.e., confined within a 2,000 foot block.

- a.** Specific route segment on which the maneuver will take place.
- b.** Distance of maximum route deviation from the centerline in miles.
- c.** Altitude.

PHRASEOLOGY–

CLEARED TO CONDUCT EVASIVE ACTION
MANEUVER FROM (fix) TO (fix),

and

(number of miles) EITHER SIDE OF CENTERLINE,

and

MAINTAIN (altitude) THROUGH (altitude),

and

COMPLETE MANEUVER AT (fix) AT (altitude).

9–3–20. NONSTANDARD FORMATION/CELL OPERATIONS

Occasionally the military is required to operate in a nonstandard cell formation and controllers should be knowledgeable of the various tactics employed and the procedures used.

REFERENCE–

FAAO 7610.4, *Chapter 12, Section 12, Formation Flight.*

a. Formation leaders are responsible for obtaining ATC approval to conduct nonstandard formation/cell operations.

b. When nonstandard formation/cell operations have been approved, controllers shall assign sufficient altitudes to allow intra-cell vertical spacing of 500 feet between each aircraft in the formation.

c. Control nonstandard formation/cell operations on the basis that MARSA is applicable between the participating aircraft until they establish approved separation which is acknowledged by ATC.

d. Apply standard separation criteria between the approved nonstandard formation/cell envelope and nonparticipating aircraft.

e. Clear aircraft operating in a nonstandard formation/cell to the breakup fix as the clearance limit. Forward data pertaining to route or altitude beyond the breakup point to the center concerned as a part of the routine flight plan information.

f. EN ROUTE. If the breakup occurs in your area, issue appropriate clearances to authorize transition from formation to individual routes or altitudes. If a breakup cannot be approved, issue an appropriate clearance for the flight to continue as a formation.

9–3–21. OPEN SKIES TREATY AIRCRAFT

a. OPEN SKIES aircraft will be identified by the call sign “OSY” (OPEN SKIES) followed by two digits and a one-letter mission suffix.

EXAMPLE–

OSY12D

Mission suffixes:

*F = Observation Flights (Priority).

*D = Demonstration Flights (Priority).

*T = Transit Flights (Nonpriority).

NOTE-

1. *Observation/Demonstration flights are conducted under rigid guidelines outlined in the Treaty of OPEN SKIES that govern sensor usage, maximum flight distances, altitudes and priorities.*

2. *Transit flights are for the sole purpose of moving an OPEN SKIES aircraft from airport to airport in preparation for an actual OPEN SKIES "F" or "D" mission.*

b. Provide priority and special handling to expedite the movement of an OPEN SKIES observation or demonstration flight.

REFERENCE-

FAAO 7110.65, Operational Priority, Para 2-1-4.

FAAO 7210.3, OPEN SKIES Treaty Aircraft, Para 5-3-7.

Treaty on OPEN SKIES, Treaty Document, 102-37.

c. OPEN SKIES aircraft, while maintaining compliance with ATC procedures, shall have priority over activities in Special Use Airspace (SUA) and shall be allowed to transit such airspace as filed after appropriate and timely coordination has been accomplished between the using agency and controlling agency.

1. OPEN SKIES Treaty flights transiting SUA will be handled in the following manner:

(a) The ATC facility controlling the OPEN SKIES flight shall advise the using/scheduling agency or appropriate ATC facility when the OPEN SKIES aircraft is fifteen (15) minutes from the SUA boundary; and

(1) For SUA that has an ATC facility providing services to the area, provide standard separation. If the ATC facility is unable to provide standard separation from the activities in the SUA, the using agency must confirm that all operations in the SUA have ceased.

(2) For SUA not associated with an ATC facility, the using/scheduling agency must return the SUA to the controlling agency and confirm that all operations in the SUA have ceased.

(b) If the controlling facility/using agency is unable to confirm that all conflicting activities in the SUA have ceased, the OPEN SKIES aircraft shall not be permitted access to the SUA.

2. Return SUA to the using agency, if appropriate, within fifteen (15) minutes after the OPEN SKIES aircraft clears the SUA.

d. Clear the aircraft according to the filed flight plan.

1. Do not ask the pilot to deviate from the planned action or route of flight except to preclude an emergency situation or other higher priority aircraft.

2. Do not impose air traffic control delays except to preclude emergency situations or other higher priority aircraft.

NOTE-

If for reasons of flight safety the route or altitude must be changed, return the aircraft to the filed flight plan route as soon as practical.

Section 4. Special Use and ATC Assigned Airspace

9-4-1. APPLICATION

Apply the procedures in this section to aircraft operating in proximity to special use or ATC assigned airspace (ATCAA) unless the airspace is designated an Alert Area/Controlled Firing Area or one of the following conditions exist:

NOTE-

These procedures are not applicable to Alert Areas or Controlled Firing Areas.

REFERENCE-

P/CG Term- Special Use Airspace.

a. The pilot informs you that permission has been obtained from the using agency to operate in the airspace.

b. The using agency informs you they have given permission for the aircraft to operate in the airspace.

NOTE-

Using agency permission may be relayed to the pilot.

c. The Restricted/Warning Area, MOA, or ATCAA has been released to the controlling agency.

d. The aircraft is on an approved ALTRV, unless the airspace area in question is an ATCAA.

NOTE-

Mission project officers are responsible for obtaining approval for ALTRV operations within Prohibited/Restricted/Warning Areas and MOAs.

REFERENCE-

FAAO 7110.65, Transiting Active SUA/ATCAA, Para 9-4-4

e. Operations in special use airspace located in offshore/oceanic airspace will be conducted in accordance with the procedures in Chapter 8, Offshore/Oceanic Procedures.

9-4-2. SEPARATION MINIMA

Unless clearance of nonparticipating aircraft in/through/adjacent to a Prohibited/Restricted/Warning Area/MOA/ATCAA is provided for in a Letter of Agreement (LOA) or Letter of Procedure (LOP), separate nonparticipating aircraft from active special use airspace by the following minima:

a. Assign an altitude consistent with para 4-5-2, Flight Direction, and 4-5-3, Exceptions, which is at

least 500 feet (above FL 290-1000 feet) above/below the upper/lower limit of the Prohibited/Restricted/Warning Area/MOA/ATCAA.

REFERENCE-

FAAO 7210.3, Prohibited/Restricted Areas, Para 2-1-17.

b. Provide radar separation of 3 miles (En route Stage A/DARC, FL 600 and above - 6 miles) from the special use airspace peripheral boundary.

c. Clear aircraft on airways or routes whose widths or protected airspace do not overlap the peripheral boundary.

d. Exception. Some Prohibited/Restricted/Warning Areas are established for security reasons or to contain hazardous activities not involving aircraft operations. Where facility management has identified these areas as outlined in FAAO 7210.3, Facility Operation and Administration, vector aircraft to remain clear of the peripheral boundary.

NOTE-

Nonparticipating aircraft refers to those aircraft for which you have separation responsibility and which have not been authorized by the using agency to operate in/through the special use airspace or ATCAA in question.

9-4-3. VFR-ON-TOP

If the aircraft's route, track, or altitude may cause it to enter an active Prohibited/Restricted/Warning Area, MOA, or ATCAA:

a. Inform the pilot to conduct flight "VFR-on-top" at least 500 feet above the upper limit or lower limit of the airspace (subject to para 7-3-1, VFR-on-top); or

PHRASEOLOGY-

MAINTAIN VFR-ON-TOP AT LEAST 500 FEET ABOVE/BELOW (upper/lower limit of airspace) ACROSS (name or number of airspace) BETWEEN (fix) AND (fix);

and if the airspace is an ATCAA,

(name of ATCAA) IS ATC ASSIGNED AIRSPACE.

REFERENCE-

FAAO 7110.65, Class A Airspace Restrictions, Para 7-1-1.

b. Clear the aircraft via a routing which provides approved separation from the airspace.

c. Exception: Some Prohibited/Restricted Areas are established for security reasons or to contain hazardous activities not involving aircraft operations. The addition of 500 (or 1,000) feet to the upper/lower limit of these Prohibited/Restricted Areas is not required if the areas have been identified by facility management.

REFERENCE-

■ FAAO 7210.3, *Prohibited/Restricted Areas, Para 2-1-17.*

9-4-4. TRANSITING ACTIVE SUA/ATCAA

If a LOA/LOP has been coordinated with the Using Agency and permission has been granted to transit the area:

a. Comply with the instruction/clearances issued by the Using Agency and provide the applicable separation minima between aircraft when two or more aircraft are transiting the area; or

NOTE-

Some Using Agencies are also air traffic control facilities.

b. If unable to comply with instructions/clearances, clear the aircraft in accordance with para 9-4-2, Separation Minima.

NOTE-

The FAA has no jurisdictional authority over the use of nonjoint use prohibited/restricted/warning area airspace; therefore, clearance cannot be issued for flight therein without the appropriate approval.

Section 5. Fuel Dumping

9-5-1. INFORMATION REQUIREMENTS

When information is received that an aircraft plans to dump fuel, determine the route and altitude it will fly and the weather conditions in which the operation will be conducted.

9-5-2. ROUTING

Except when it is dumping fuel for emergency reasons, an aircraft in either VFR or IFR conditions may be requested to fly a different route.

9-5-3. ALTITUDE ASSIGNMENT

If an aircraft is dumping fuel in IFR conditions, assign an altitude at least 2,000 feet above the highest obstacle within 5 miles of the route or pattern being flown.

9-5-4. SEPARATION MINIMA

Separate known aircraft from the aircraft dumping fuel as follows:

- a. IFR aircraft by one of the following:

1. *1,000 feet* above it; or in accordance with para 4-5-1, Vertical Separation Minima, whichever is greater.

2. *2,000 feet* below it.

3. *5 miles* radar.

4. *5 miles* laterally.

b. VFR radar-identified aircraft by *5 miles* and in accordance with para 5-6-1, Application.

9-5-5. INFORMATION DISSEMINATION

a. If you are in contact with an aircraft when it starts dumping fuel, inform other controllers and facilities which might be concerned. Facilities concerned shall broadcast an advisory on appropriate radio frequencies at 3-minute intervals until the dumping stops.

PHRASEOLOGY-

ATTENTION ALL AIRCRAFT.

FUEL DUMPING IN PROGRESS OVER (location) AT (altitude) BY (type aircraft) (flight direction).

b. Broadcast a terminating advisory when the fuel dumping operation is completed.

PHRASEOLOGY-

ATTENTION ALL AIRCRAFT.

FUEL DUMPING OVER (location) TERMINATED.

Section 6. Jettisoning of External Stores

9-6-1. JETTISONING OF EXTERNAL STORES

At locations where a drop area has been established for radar assistance in jettisoning of external stores, provide vectoring service upon request to:

NOTE-

1. Where required, a mutually satisfactory drop area for the jettisoning of external stores will be determined by radar-equipped towers and centers in cooperation with the local USAF units, Air Division, or civil operators and civil aircraft companies concerned.

2. *FAA and Headquarters, USAF, have agreed to allow FAA facilities to vector USAF, Air Force Reserve, and Air National Guard aircraft for jettisoning of all external stores; i.e., tip tanks, JATO racks, special weapons, etc. Any similar vectoring service given to civil operators and civil aircraft companies operating Air Force type aircraft requires written agreement between the FAA and the user to relieve the FAA of possible liability. The regional counsel's office acts for FAA in executing this agreement.*

a. USAF, ANG, and Air Force Reserve aircraft at any time.

b. Civil operators and civil aircraft when a written agreement is in effect for your location.

Section 7. Unmanned Free Balloons

9-7-1. APPLICATION

FIG 9-7-1

Shapes of 11 Million Cubic Feet Balloon
at Various Altitudes

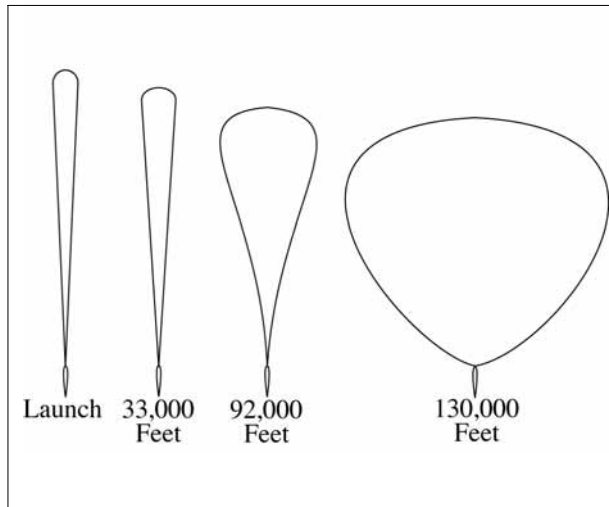

Apply the following procedures, as appropriate, when unmanned free balloons are within airspace for which you have control jurisdiction:

NOTE-

These procedures apply to unmanned free balloons that carry payloads as described in 14 CFR Section 101.1(a)(4). Payloads may weigh several hundred pounds and the physical shape of the balloons change at various altitudes/flight levels. (See FIG 9-7-1.) Balloon and payload ascend at an average rate of 400 feet a minute. Over the descent area, the payload is normally released from the balloon and descends by parachute at a minimum rate of 1,000 feet a minute. The balloon is normally deflated automatically when the payload is released. The operator is required to advise ATC 1 hour in advance of descent in accordance with 14 CFR Section 101.39.

a. Post the balloon flight on flight progress strips along the planned trajectory and revise routing as tracking/position reports require.

NOTE-

The prelaunch notice information should be posted on flight progress strips for planning and operational purposes.

b. Radar flight follow balloons to the extent that equipment capabilities permit. If radar flight following is not possible, tracking should be

attempted by communication with the “chase plane,” telephone contact with the operator, pilot, or ground observation reports.

NOTE-

Some operators have equipped their balloons with transponder beacons in addition to a radar reflection device or material required by 14 CFR Section 101.35, but at cruise altitude, the balloon’s communications equipment and transponder, if so equipped, are operated intermittently to conserve battery energy.

c. With pilot concurrence, provide separation between aircraft and balloons when you are satisfied that the balloon information is sufficiently reliable to provide the service. Do not attempt to separate aircraft from the balloon by using vertical separation unless you have accurate balloon altitude information.

d. Provide traffic advisories to all affected aircraft during initial contact specifying the balloon’s known or estimated position, direction of movement, and altitude as “unknown” or “reported,” as appropriate.

NOTE-

Unless ATC requires otherwise, operators of unmanned free balloons are required to monitor the course of the balloon and record its position at least every two hours. As required in 14 CFR Section 101.39a, balloon position reports are not forwarded by the operator unless requested by ATC.

PHRASEOLOGY-

UNMANNED FREE BALLOON OVER (name of location),

or

ESTIMATED OVER (name of location), MOVING (direction of movement).

LAST REPORTED ALTITUDE AT (altitude as reported by the operator or determined from pilot report),

or

ALTITUDE UNKNOWN.

e. To transfer flight following responsibility of balloons between facilities or between controllers, forward the following information when available:

REFERENCE-

14 CFR Section 101.37, Notice Requirements.
14 CFR Section 101.39, Balloon Position Reports.

1. Identification and type; e.g., Flight 804 Balloon.
2. Last known position and altitude.
3. General direction of movement and speed.
4. ETA over facility boundary, sector boundary, or other point if believed to be reasonably accurate.
5. Other pertinent information.
6. If in radar contact, physically point out the target to the receiving controller.
7. The name and the telephone number of the location where tracking is being accomplished.

REFERENCE-

FAAO 7110.65, *Derelict Balloons, Para 9-7-2*

9-7-2. DERELICT BALLOONS

Balloons become derelict when a moored balloon slips its mooring and becomes a hazard to air navigation or when an unmanned free balloon flight cannot be terminated as planned. When this occurs:

- a. In the case of a moored balloon which has slipped its moorings, issue traffic advisories.
- b. In the case of an unmanned free balloon, flight follow the balloon and, to the extent possible, provide aircraft under your control separation from the balloon.
- c. Forward balloon position information received from pilot reports or derived from radar returns to your supervisor for further dissemination.

- d. If radar contact with the balloon is lost, broadcast an advisory to all aircraft operating in the airspace affected by the derelict balloon at 10-minute intervals continuing until the derelict balloon is no longer a factor.

PHRASEOLOGY-

ADVISORY TO ALL AIRCRAFT.

DERELICT BALLOON REPORTED IN THE VICINITY OF (location),

or

ESTIMATED IN VICINITY OF (location),

or

REPORTED OVER (location),

or

RADAR REPORTED OVER (location).

LAST REPORTED ALTITUDE/FLIGHT LEVEL AT (altitude/flight level as reported by operator or pilot report),

or

ALTITUDE/FLIGHT LEVEL UNKNOWN.

- e. Transfer flight following responsibility as outlined in para 9-7-1, Application, subpara e.

REFERENCE-

FAAO 7210.3, *Derelict Balloons/Objects, Para 18-6-2.*

Section 8. Parachute Operations

9-8-1. COORDINATION

Coordinate any pertinent information prior to and at the end of each parachute jump or series of jumps which begins or ends in your area of jurisdiction with other affected ATC facilities/sectors.

NOTE-

14 CFR Section 105.15 prescribes the information required from each person requesting authorization or submitting notification for nonemergency parachute jumping activity.

REFERENCE-

*FAAO 7210.3, Nonemergency Parachute Jump Operations, Para 18-5-1.
14 CFR Part 105, Parachute Operations.*

9-8-2. CLASS A, CLASS B, AND CLASS C AIRSPACE

a. Authorize parachute operations only within airspace designated for the jumping activity.

b. Separate aircraft, other than those participating in the jump operation, from the airspace authorized for the jumping activity.

c. Impose, as necessary, any conditions and restrictions which in your judgment would promote the safety of the operation.

REFERENCE-

14 CFR Section 105.25, Parachute Operations in Designated Airspace.

9-8-3. CLASS D AIRSPACE

TERMINAL

Handle requests to conduct jump operations in or into Class D airspace in which there is a functioning control tower as follows:

a. Authorize parachute jumping with respect to known or observed traffic.

b. Issue advisory information to the jump aircraft and to nonparticipating aircraft as necessary for the safe conduct of the jump operation.

9-8-4. OTHER CONTROL AIRSPACE

Handle notifications to conduct jump operations in other Class E airspace as follows:

a. Issue a traffic advisory to the jump aircraft before the jump. Include aircraft type, altitude, and direction of flight of all known traffic which will transit the airspace within which the jump will be conducted.

NOTE-

14 CFR Section 105.13, Radio Equipment and Use Requirements, prescribes that, except when otherwise authorized by ATC, parachute jumping is not allowed in or into Class E airspace unless radio communications have been established between the aircraft and the FAA ATC facility having jurisdiction over the affected airspace of the first intended exit altitude at least 5 minutes before the jumping activity is to begin for the purpose of receiving information in the aircraft about known air traffic in the vicinity of the jump aircraft.

b. Issue advisories to all known aircraft which will transit the airspace within which the jump operations will be conducted. Advisories shall consist of the location, time, duration, and altitude from which the jump will be made.

c. When time or numbers of aircraft make individual transmissions impractical, advisories to nonparticipating aircraft may be broadcast on appropriate control frequencies, or when available, the ATIS broadcast.

d. When requested by the pilot and to the extent possible, assist nonparticipating aircraft to avoid the airspace within which the jump will be conducted.

Section 9. Unidentified Flying Object (UFO) Reports

9-9-1. GENERAL

a. Persons wanting to report UFO/Unexplained Phenomena activity should contact an UFO/Unexplained Phenomena Reporting Data Collection Center, such as the National Institute for Discovery

Sciences (NIDS), the National UFO Reporting Center, etc.

b. If concern is expressed that life or property might be endangered, report the activity to the local law enforcement department.

Chapter 10. Emergencies

Section 1. General

10-1-1. EMERGENCY DETERMINATIONS

a. An emergency can be either a *Distress* or an *Urgency* condition as defined in the “Pilot/Controller Glossary.”

b. A pilot who encounters a *Distress* condition should declare an emergency by beginning the initial communication with the word “Mayday,” preferably repeated three times. For an *Urgency* condition, the word “Pan-Pan” should be used in the same manner.

c. If the words “Mayday” or “Pan-Pan” are not used and you are in doubt that a situation constitutes an emergency or potential emergency, handle it as though it were an emergency.

d. Because of the infinite variety of possible emergency situations, specific procedures cannot be prescribed. However, when you believe an emergency exists or is imminent, select and pursue a course of action which appears to be most appropriate under the circumstances and which most nearly conforms to the instructions in this manual.

REFERENCE-

FAAO 7110.65, *IFR Military Training Routes, Para 9-3-7*

10-1-2. OBTAINING INFORMATION

Obtain enough information to handle the emergency intelligently. Base your decision as to what type of assistance is needed on information and requests received from the pilot because he/she is authorized by 14 CFR Part 91 to determine a course of action.

10-1-3. PROVIDING ASSISTANCE

Provide maximum assistance to aircraft in distress. Enlist the services of available radar facilities and DF facilities operated by the FAA, the military services, and the Federal Communications Commission, as well as their emergency services and facilities, when the pilot requests or when you deem necessary.

REFERENCE-

FAAO 7110.65, *Operational Priority, Para 2-1-4*

10-1-4. RESPONSIBILITY

a. If you are in communication with an aircraft in distress, handle the emergency and coordinate and direct the activities of assisting facilities. Transfer this responsibility to another facility only when you feel better handling of the emergency will result.

b. When you receive information about an aircraft in distress, forward detailed data to the center in whose area the emergency exists.

NOTE-

1. Centers serve as the central points for collecting information, for coordinating with SAR, and for conducting a communications search by distributing any necessary ALNOTs concerning:

a. Overdue or missing IFR aircraft.

b. Aircraft in an emergency situation occurring in their respective area.

c. Aircraft on a combination VFR/IFR or an airfiled IFR flight plan and 30 minutes have passed since the pilot requested IFR clearance and neither communication nor radar contact can be established with it. For SAR purposes, these aircraft are treated the same as IFR aircraft.

d. Overdue or missing aircraft which have been authorized to operate in accordance with special VFR clearances.

2. Notifying the center about a VFR aircraft emergency allows provision of IFR separation if considered necessary.

REFERENCE-

FAAO 7110.65, *Emergency Situations, Para 10-2-5*

FAAO 7110.65, *Information to be Forwarded to ARTCC, Para 10-3-2*

FAAO 7110.65, *Information to be Forwarded to RCC, Para 10-3-3*

c. If the aircraft involved is operated by a foreign air carrier, notify the center serving the departure or destination point, when either point is within the U.S., for relay to the operator of the aircraft.

d. The ARTCC shall be responsible for receiving and relaying all pertinent ELT signal information to the appropriate authorities.

REFERENCE-

FAAO 7110.65, *Emergency Locator Transmitter (ELT) Signals, Para 10-2-10*

e. When consideration is given to the need to escort an aircraft in distress, evaluate the close formation required by both aircraft. Special consideration should be given if the maneuver takes the aircraft through the clouds.

f. Before a determination is made to have an aircraft in distress be escorted by another aircraft, ask the pilots if they are familiar with and capable of formation flight.

1. Do not allow aircraft to join up in formation during emergency conditions, unless:

(a) The pilots involved are familiar with and capable of formation flight.

(b) They can communicate with one another, and have visual contact with each other.

2. If there is a need for aircraft that are not designated as search and rescue aircraft to get closer to one another than radar separation standards allow, the maneuver shall be accomplished, visually, by the aircraft involved.

10-1-5. COORDINATION

Coordinate efforts to the extent possible to assist any aircraft believed overdue, lost, or in emergency status.

10-1-6. AIRPORT GROUND EMERGENCY

TERMINAL

a. When an emergency occurs on the airport proper, control other air and ground traffic to avoid conflicts in the area where the emergency is being handled. This also applies when routes within the airport proper are required for movement of local emergency equipment going to or from an emergency which occurs outside the airport proper.

NOTE-

Aircraft operated in proximity to accident or other emergency or disaster locations may cause hindrances to airborne and surface rescue or relief operations. Congestion, distraction or other effects, such as wake turbulence from nearby airplanes and helicopters, could prevent or delay proper execution of these operations.

REFERENCE-

*FAAO 7210.3, Chapter 19, Temporary Flight Restrictions.
14 CFR Section 91.137, Temporary Flight Restrictions.*

b. Workload permitting, monitor the progress of emergency vehicles responding to a situation. If necessary, provide available information to assist responders in finding the accident/incident scene.

10-1-7. INFLIGHT EMERGENCIES INVOLVING MILITARY FIGHTER-TYPE AIRCRAFT

a. The design and complexity of military fighter-type aircraft places an extremely high workload on the pilot during an inflight emergency. The pilot's full attention is required to maintain control of the aircraft. Therefore, radio frequency and transponder code changes should be avoided and radio transmissions held to a minimum, especially when the aircraft experiencing the emergency is at low altitude.

b. Pilots of military fighter-type aircraft, normally single engine, experiencing or anticipating loss of engine power or control may execute a flameout pattern in an emergency situation. Circumstances may dictate that the pilot, depending on the position and nature of the emergency, modify the pattern based on actual emergency recovery requirements.

c. Military airfields with an assigned flying mission may conduct practice emergency approaches. Participating units maintain specific procedures for conducting these operations.

REFERENCE-

FAAO 7110.65, Simulated Flameout (SFO) Approaches/Emergency Landing Pattern (ELP) Operations/Practice Precautionary Approaches, Para 3-10-13

Section 2. Emergency Assistance

10-2-1. INFORMATION REQUIREMENTS

a. Start assistance as soon as enough information has been obtained upon which to act. Information requirements will vary, depending on the existing situation. Minimum required information for inflight emergencies is:

NOTE-

In the event of an ELT signal see para 10-2-10 Emergency Locator Transmitter (ELT) Signals.

1. Aircraft identification and type.
2. Nature of the emergency.
3. Pilot's desires.

b. After initiating action, obtain the following items or any other pertinent information from the pilot or aircraft operator, as necessary:

NOTE-

Normally, do not request this information from military fighter-type aircraft that are at low altitudes (i.e. on approach, immediately after departure, on a low level route, etc.). However, request the position of an aircraft that is not visually sighted or displayed on radar if the location is not given by the pilot.

1. Aircraft altitude.
2. Fuel remaining in time.
3. Pilot reported weather.
4. Pilot capability for IFR flight.
5. Time and place of last known position.
6. Heading since last known position.
7. Airspeed.
8. Navigation equipment capability.
9. NAVAID signals received.
10. Visible landmarks.
11. Aircraft color.
12. Number of people on board.
13. Point of departure and destination.
14. Emergency equipment on board.

10-2-2. FREQUENCY CHANGES

Although 121.5 MHz and 243.0 MHz are emergency frequencies, it might be best to keep the aircraft on the initial contact frequency. Change frequencies only when there is a valid reason.

10-2-3. AIRCRAFT ORIENTATION

Orientate an aircraft by the means most appropriate to the circumstances. Recognized methods include:

- a. Radar.
- b. DF.
- c. NAVAIDs.
- d. Pilotage.
- e. Sighting by other aircraft.

10-2-4. ALTITUDE CHANGE FOR IMPROVED RECEPTION

When you consider it necessary and if weather and circumstances permit, recommend that the aircraft maintain or increase altitude to improve communications, radar, or DF reception.

NOTE-

Aircraft with high-bypass turbofan engines (such as B747) encountering volcanic ash clouds have experienced total loss of power to all engines. Damage to engines due to volcanic ash ingestion increases as engine power is increased, therefore, climb while in the ash cloud is to be avoided where terrain permits.

REFERENCE-

AIM, Flight Operations in Volcanic Ash, Para 7-5-8.

10-2-5. EMERGENCY SITUATIONS

Consider that an aircraft emergency exists and inform the RCC or ARTCC and alert the appropriate DF facility when:

NOTE-

1. *USAF facilities are only required to notify the ARTCC.*
2. *The requirement to alert DF facilities may be deleted if radar contact will be maintained throughout the duration of the emergency.*
 - a. An emergency is declared by either:
 1. The pilot.
 2. Facility personnel.

3. Officials responsible for the operation of the aircraft.

b. There is unexpected loss of radar contact and radio communications with any IFR or VFR aircraft.

c. Reports indicate it has made a forced landing, is about to do so, or its operating efficiency is so impaired that a forced landing will be necessary.

d. Reports indicate the crew has abandoned the aircraft or is about to do so.

e. An emergency radar beacon response is received.

NOTE-

EN ROUTE. During Stage A operation, **Code 7700** causes **EMRG** to blink in field E of the data block.

f. Intercept or escort aircraft services are required.

g. The need for ground rescue appears likely.

h. An Emergency Locator Transmitter (ELT) signal is heard or reported.

REFERENCE-

FAAO 7110.65, *Providing Assistance, Para 10-1-3*

FAAO 7110.65, *Emergency Locator Transmitter (ELT) Signals, Para 10-2-10*

10-2-6. HIJACKED AIRCRAFT

When you observe a Mode 3/A Code 7500, an unexplained loss of beacon code, change in direction of flight or altitude, and/or a loss of communications, notify supervisory personnel immediately. As it relates to observing a Code 7500, do the following:

NOTE-

Military facilities will notify the appropriate FAA ARTCC, or the host nation agency responsible for en route control, of any indication that an aircraft is being hijacked. They will also provide full cooperation with the civil agencies in the control of such aircraft.

EN ROUTE. During narrowband radar operations, **Code 7500** causes **HIJK** to blink in the data block.

NOTE-

Only nondiscrete Code 7500 will be decoded as the hijack code.

a. Acknowledge and confirm receipt of **Code 7500** by asking the pilot to verify it. If the aircraft is not being subjected to unlawful interference, the pilot should respond to the query by broadcasting in the clear that he/she is not being subjected to unlawful interference. If the reply is in the affirmative or if no reply is received, do not

question the pilot further but be responsive to the aircraft requests.

PHRASEOLOGY-

(Identification) (name of facility) VERIFY SQUAWKING 7500.

NOTE-

Code 7500 is only assigned upon notification from the pilot that his/her aircraft is being subjected to unlawful interference. Therefore, pilots have been requested to refuse the assignment of Code 7500 in any other situation and to inform the controller accordingly.

b. Notify supervisory personnel of the situation.

c. Flight follow aircraft and use normal handoff procedures without requiring transmissions or responses by aircraft unless communications have been established by the aircraft.

d. If aircraft are dispatched to escort the hijacked aircraft, provide all possible assistance to the escort aircraft to aid in placing them in a position behind the hijacked aircraft.

NOTE-

Escort procedures are contained in FAAO 7610.4, Special Military Operations, Chapter 7, Escort of Hijacked Aircraft.

e. To the extent possible, afford the same control service to the aircraft operating VFR observed on the hijack code.

REFERENCE-

FAAO 7110.65, *Code Monitor, Para 5-2-13*

10-2-7. VFR AIRCRAFT IN WEATHER DIFFICULTY

a. If VFR aircraft requests assistance when it encounters or is about to encounter IFR weather conditions, determine the facility best able to provide service. If a frequency change is necessary, advise the pilot of the reason for the change, and request the aircraft contact the appropriate control facility. Inform that facility of the situation. If the aircraft is unable to communicate with the control facility, relay information and clearances.

b. The following shall be accomplished on a Mode C equipped VFR aircraft which is in emergency but no longer requires the assignment of **Code 7700**:

1. **TERMINAL.** Assign a beacon code that will permit terminal minimum safe altitude warning (MSAW) alarm processing.

2. EN ROUTE. An appropriate keyboard entry shall be made to ensure en route MSAW (EMSAW) alarm processing.

10-2-8. RADAR ASSISTANCE TO VFR AIRCRAFT IN WEATHER DIFFICULTY

a. If a VFR aircraft requests radar assistance when it encounters or is about to encounter IFR weather conditions, ask the pilot if he/she is qualified for and capable of conducting IFR flight.

b. If the pilot states he/she is qualified for and capable of IFR flight, request him/her to file an IFR flight plan and then issue clearance to destination airport, as appropriate.

c. If the pilot states he/she is not qualified for or not capable of conducting IFR flight, or if he/she refuses to file an IFR flight plan, take whichever of the following actions is appropriate:

1. Inform the pilot of airports where VFR conditions are reported, provide other available pertinent weather information, and ask if he/she will elect to conduct VFR flight to such an airport.

2. If the action in subpara 1 above is not feasible or the pilot declines to conduct VFR flight to another airport, provide radar assistance if the pilot:

(a) Declares an emergency.

(b) Refuses to declare an emergency and you have determined the exact nature of the radar services the pilot desires.

3. If the aircraft has already encountered IFR conditions, inform the pilot of the appropriate terrain/obstacle clearance minimum altitude. If the aircraft is below appropriate terrain/obstacle clearance minimum altitude and sufficiently accurate position information has been received or radar identification is established, furnish a heading or radial on which to climb to reach appropriate terrain/obstacle clearance minimum altitude.

d. The following shall be accomplished on a Mode C equipped VFR aircraft which is in emergency but no longer requires the assignment of **Code 7700**:

1. TERMINAL. Assign a beacon code that will permit terminal minimum safe altitude warning (MSAW) alarm processing.

2. EN ROUTE. An appropriate keyboard entry shall be made to ensure en route MSAW (EMSAW) alarm processing.

10-2-9. RADAR ASSISTANCE TECHNIQUES

Use the following techniques to the extent possible when you provide radar assistance to a pilot not qualified to operate in IFR conditions:

a. Avoid radio frequency changes except when necessary to provide a clear communications channel.

b. Make turns while the aircraft is in VFR conditions so it will be in a position to fly a straight course while in IFR conditions.

c. Have pilot lower gear and slow aircraft to approach speed while in VFR conditions.

d. Avoid requiring a climb or descent while in a turn if in IFR conditions.

e. Avoid abrupt maneuvers.

f. Vector aircraft to VFR conditions.

g. The following shall be accomplished on a Mode C equipped VFR aircraft which is in emergency but no longer requires the assignment of **Code 7700**:

1. TERMINAL. Assign a beacon code that will permit terminal minimum safe altitude warning (MSAW) alarm processing.

2. EN ROUTE. An appropriate keyboard entry shall be made to ensure en route MSAW (EMSAW) alarm processing.

10-2-10. EMERGENCY LOCATOR TRANSMITTER (ELT) SIGNALS

When an ELT signal is heard or reported:

a. EN ROUTE. Notify the Rescue Coordination Center (RCC).

NOTE-

FAA Form 7210-8, ELT INCIDENT, contains standardized format for coordination with the RCC.

REFERENCE-

FAAO 7210.3, FAA Form 7210-8, ELT Incident, Para 9-3-1.

b. TERMINAL. Notify the ARTCC which will coordinate with the RCC.

NOTE-

1. *Operational ground testing of emergency locator transmitters (ELTs) has been authorized during the first 5 minutes of each hour. To avoid confusing the tests with an actual alarm, the testing is restricted to no more than three audio sweeps.*

2. *Controllers can expect pilots to report aircraft position and time the signal was first heard, aircraft position and time the signal was last heard, aircraft position at maximum signal strength, flight altitude, and frequency of the emergency signal (121.5/243.0). (See AIM, Emergency Locator Transmitter (ELT), Para 6-2-5.)*

c. EN ROUTE. Request DF facilities obtain fixes or bearings on signal. Forward bearings or fixes obtained plus any other pertinent information to the RCC.

d. TERMINAL. Attempt to obtain fixes or bearings on the signal.

e. Solicit the assistance of other aircraft known to be operating in the signal area.

f. TERMINAL. Forward fixes or bearings and any other pertinent information to the ARTCC.

NOTE-

Fix information in relation to a VOR or VORTAC (radial-distance) facilitates accurate ELT plotting by RCC and should be provided when possible.

g. EN ROUTE. When the ELT signal strength indicates the signal may be emanating from somewhere on an airport or vicinity thereof, notify the on-site airway facilities personnel and the Regional Operations Center (ROC) for their actions. This action is in addition to the above.

h. TERMINAL. When the ELT signal strength indicates the signal may be emanating from somewhere on the airport or vicinity thereof, notify the on-site airway facilities personnel and the ARTCC for their action. This action is in addition to the above.

i. Air Traffic personnel shall not leave their required duty stations to locate an ELT signal source.

NOTE-

Portable handcarried receivers assigned to air traffic facilities (where no airway facilities personnel are available) may be loaned to responsible airport personnel or local authorities to assist in locating the ELT signal source.

j. EN ROUTE. Notify the RCC, the ROC, and alerted DF facilities if signal source is located/terminated.

k. TERMINAL. Notify the ARTCC if signal source is located/terminated.

REFERENCE-

FAAO 7110.65, Responsibility, Para 10-1-4

FAAO 7110.65, Information Requirements, Para 10-2-1

10-2-11. AIRCRAFT BOMB THREATS

a. When information is received from any source that a bomb has been placed on, in, or near an aircraft for the purpose of damaging or destroying such aircraft, notify your supervisor or the facility air traffic manager. If the threat is general in nature, handle it as a "Suspicious Activity." When the threat is targeted against a specific aircraft and you are in contact with the suspect aircraft, take the following actions as appropriate:

NOTE-

1. *Facility supervisors are expected to notify the appropriate offices, agencies, operators/air carriers according to applicable plans, directives, and FAAO 7210.3, Facility Operation and Administration, Handling Bomb Threat Incidents, Para 2-1-8, or applicable military directives.*

2. *"Suspicious activity" is covered in FAAO 7210.3, Facility Operation and Administration, Suspicious Activities, Para 2-7-6. Military facilities would report a "general" threat through the chain of command or according to service directives.*

1. Advise the pilot of the threat.

2. Inform the pilot that technical assistance can be obtained from an FAA aviation explosives expert.

NOTE-

An FAA aviation explosive expert is on call at all times and may be contacted by calling the FAA Operations Center, Washington, DC, Area Code 202-267-3333, ETN 521-0111, or DSN 851-3750. Technical advice can be relayed to assist civil or military air crews in their search for a bomb and in determining what precautionary action to take if one is found.

3. Ask the pilot if he/she desires to climb or descend to an altitude that would equalize or reduce the outside air pressure/existing cabin air pressure differential. Issue or relay an appropriate clearance considering MEA, MOCA, MRA, and weather.

NOTE-

Equalizing existing cabin air pressure with outside air pressure is a key step which the pilot may wish to take to minimize the damage potential of a bomb.

4. Handle the aircraft as an emergency and/or provide the most expeditious handling possible with respect to the safety of other aircraft, ground facilities, and personnel.

NOTE-

Emergency handling is discretionary and should be based on the situation. With certain types of threats, plans may call for a low-key action or response.

5. Issue or relay clearances to a new destination if requested.

6. When a pilot requests technical assistance or if it is apparent that a pilot may need such assistance, do NOT suggest what actions the pilot should take concerning a bomb, but obtain the following information and notify your supervisor who will contact the FAA aviation explosives expert:

NOTE-

This information is needed by the FAA aviation explosives expert so that he/she can assess the situation and make immediate recommendations to the pilot. The aviation explosives expert may not be familiar with all military aircraft configurations but he/she can offer technical assistance which would be beneficial to the pilot.

(a) Type, series, and model of the aircraft.

(b) Precise location/description of the bomb device if known.

(c) Other details which may be pertinent.

NOTE-

The following details may be of significance if known, but it is not intended that the pilot should disturb a suspected bomb/bomb container to ascertain the information: The altitude or time set for the bomb to explode, type of detonating action (barometric, time, anti-handling, remote radio transmitter), power source (battery, electrical, mechanical), type of initiator (blasting cap, flash bulb, chemical), and the type of explosive/incendiary charge (dynamite, black powder, chemical).

b. When a bomb threat involves an aircraft on the ground and you are in contact with the suspect aircraft, take the following actions in addition to those discussed in the preceding paragraphs which may be appropriate:

1. If the aircraft is at an airport where tower control or FSS advisory service is not available, or if the pilot ignores the threat at any airport, recommend that takeoff be delayed until the pilot or aircraft operator establishes that a bomb is not aboard in accordance with 14 CFR Part 121. If the pilot insists

on taking off and in your opinion the operation will not adversely affect other traffic, issue or relay an ATC clearance.

REFERENCE-

14 CFR Section 121.538, Airplane Security.

2. Advise the aircraft to remain as far away from other aircraft and facilities as possible, to clear the runway, if appropriate, and to taxi to an isolated or designated search area. When it is impractical or if the pilot takes an alternative action; e.g., parking and off-loading immediately, advise other aircraft to remain clear of the suspect aircraft by at least 100 yards if able.

NOTE-

Passenger deplaning may be of paramount importance and must be considered before the aircraft is parked or moved away from service areas. The decision to use ramp facilities rests with the pilot, aircraft operator/airport manager.

c. If you are unable to inform the suspect aircraft of a bomb threat or if you lose contact with the aircraft, advise your supervisor and relay pertinent details to other sectors or facilities as deemed necessary.

d. When a pilot reports the discovery of a bomb or suspected bomb on an aircraft which is airborne or on the ground, determine the pilot's intentions and comply with his/her requests in so far as possible. Take all of the actions discussed in the preceding paragraphs which may be appropriate under the existing circumstances.

e. The handling of aircraft when a hijacker has or is suspected of having a bomb requires special considerations. Be responsive to the pilot's requests and notify supervisory personnel. Apply hijacking procedures and offer assistance to the pilot according to the preceding paragraphs, if needed.

10-2-12. EXPLOSIVE DETECTION K-9 TEAMS

Take the following actions should you receive an aircraft request for the location of the nearest explosive detection K-9 team.

REFERENCE-

FAAO 7210.3, Explosives Detection K-9 Teams, Para 2-1-11.

a. Obtain the aircraft identification and position and advise your supervisor of the pilot request.

b. When you receive the nearest location of the explosive detection K-9 team, relay the information to the pilot.

c. If the aircraft wishes to divert to the airport location provided, obtain an estimated arrival time from the pilot and advise your supervisor.

10-2-13. MANPADS ALERT

When a threat or attack from Man-Portable Air Defense Systems (MANPADS) is determined to be real, notify and advise aircraft as follows:

a. Do not withhold landing clearance. To the extent possible, issue information on MANPADS threats, confirmed attacks, or post-event activities in time for it to be useful to the pilot. The pilot or parent company will determine the pilot's actions.

b. MANPADS information will be disseminated via the ATIS and/or controller-to-pilot transmissions.

c. Disseminate via controller-to-pilot transmission until the appropriate MANPADS information is broadcast via the ATIS and pilots indicate they have received the appropriate ATIS code. MANPADS information will include nature and location of threat or incident, whether reported or observed and by whom, time (if known), and when transmitting to an individual aircraft, a request for pilot's intentions.

PHRASEOLOGY-

ATTENTION (aircraft identification), MANPADS ALERT. EXERCISE EXTREME CAUTION. MANPADS THREAT/ATTACK/POST-EVENT ACTIVITY OBSERVED/REPORTED BY (reporting agency) (location) AT (time, if known). (When transmitting to an individual aircraft) SAY INTENTIONS.

EXAMPLE-

"Attention Eastern Four Seventeen, MANPADS alert. Exercise extreme caution. MANPADS threat reported by TSA, LaGuardia vicinity. Say intentions."

"Attention all aircraft, MANPADS alert. Exercise extreme caution. MANPADS post-event activity observed by tower south of airport at two-one-zero-zero Zulu."

d. Report MANPADS threat/attack/post-event activity until notified otherwise by FAA national headquarters.

REFERENCE-

FAAO 7110.65, Content, Para 2-9-3.

FAAO 7210.3, Handling MANPADS Incidents, Para 2-1-9.

10-2-14. EMERGENCY AIRPORT RECOMMENDATION

a. Consider the following factors when recommending an emergency airport:

1. Remaining fuel in relation to airport distances.
2. Weather conditions.

NOTE-

Depending on the nature of the emergency, certain weather phenomena may deserve weighted consideration when recommending an airport; e.g., a pilot may elect to fly farther to land at an airport with VFR instead of IFR conditions.

3. Airport conditions.
4. NAVAID status.
5. Aircraft type.
6. Pilot's qualifications.
7. Vectoring or homing capability to the emergency airport.

b. Consideration to the provisions of subpara a and para 10-2-15, Guidance to Emergency Airport, shall be used in conjunction with the information derived from any automated emergency airport information source.

10-2-15. GUIDANCE TO EMERGENCY AIRPORT

a. When necessary, use any of the following for guidance to the airport:

1. Radar.
2. DF.
3. Following another aircraft.
4. NAVAIDs.
5. Pilotage by landmarks.
6. Compass headings.

b. Consideration to the provisions of para 10-2-14, Emergency Airport Recommendation, shall be used in conjunction with the information derived from any automated emergency airport information source.

10-2-16. EMERGENCY OBSTRUCTION VIDEO MAP (EOVM)

a. The EOVM is intended to facilitate advisory service to an aircraft in an emergency situation wherein an appropriate terrain/obstacle clearance minimum altitude cannot be maintained. It shall only be used and the service provided under the following conditions:

1. The pilot has declared an emergency, or
2. The controller has determined that an emergency condition exists or is imminent because of the pilot's inability to maintain an appropriate terrain/obstacle clearance minimum altitude.

NOTE-

Appropriate terrain/obstacle clearance minimum altitudes may be defined as Minimum IFR Altitude (MIA), Minimum En Route Altitude (MEA), Minimum Obstruction Clearance Altitude (MOCA), or Minimum Vectoring Altitude (MVA).

b. When providing emergency vectoring service, the controller shall advise the pilot that any headings issued are emergency advisories intended only to direct the aircraft toward and over an area of lower terrain/obstacle elevation.

NOTE-

Altitudes and obstructions depicted on the EOVM are the actual altitudes and locations of the obstacle/terrain and contain no lateral or vertical buffers for obstruction clearance.

REFERENCE-

FAAO 7210.3, Emergency Obstruction Video Map (EOVM), Para 3-9-4.

10-2-17. VOLCANIC ASH

a. If a volcanic ash cloud is known or forecast to be present:

1. Relay all information available to pilots to ensure that they are aware of the ash cloud's position and altitude(s).
2. Suggest appropriate reroutes to avoid the area of known or forecast ash clouds.

NOTE-

Volcanic ash clouds are not normally detected by airborne or air traffic radar systems.

b. If advised by an aircraft that it has entered a volcanic ash cloud and indicates that a distress situation exists:

1. Consider the aircraft to be in an emergency situation.
2. Do not initiate any climb clearances to turbine-powered aircraft until the aircraft has exited the ash cloud.
3. Do not attempt to provide escape vectors without pilot concurrence.

NOTE-

1. *The recommended escape maneuver is to reverse course and begin a descent (if terrain permits). However, it is the pilot's responsibility to determine the safest escape route from the ash cloud.*

2. *Controllers should be aware of the possibility of complete loss of power to any turbine-powered aircraft that encounters an ash cloud.*

REFERENCE-

*FAAO 7110.65, Altitude Change for Improved Reception, Para 10-2-4
AIM, Flight Operations in Volcanic Ash, Para 7-5-8.*

Section 3. Overdue Aircraft

10-3-1. OVERDUE AIRCRAFT

a. Consider an aircraft to be overdue, initiate the procedures stated in this section and issue an ALNOT when neither communications nor radar contact can be established and 30 minutes have passed since:

NOTE-

The procedures in this section also apply to an aircraft referred to as "missing" or "unreported."

1. Its ETA over a specified or compulsory reporting point or at a clearance limit in your area.

2. Its clearance void time.

b. If you have reason to believe that an aircraft is overdue prior to 30 minutes, take the appropriate action immediately.

c. The center in whose area the aircraft is first unreported or overdue will make these determinations and takes any subsequent action required.

REFERENCE-

FAAO 7110.65, Departure Restrictions, Clearance Void Times, Hold for Release, and Release Times, Para 4-3-4

10-3-2. INFORMATION TO BE FORWARDED TO ARTCC

TERMINAL

When an aircraft is considered to be in emergency status that may require SAR procedures, or an IFR aircraft is overdue, the terminal facility shall alert the ARTCC and forward the following information, as available:

a. Flight plan, including color of aircraft, if known.

b. Time of last transmission received, by whom, and frequency used.

c. Last position report and how determined.

d. Action taken by reporting facility and proposed action.

e. Number of persons on board.

f. Fuel status.

g. Facility working aircraft and frequency.

h. Last known position, estimated present position, and maximum range of flight of the aircraft based on remaining fuel and airspeed.

i. Position of other aircraft near aircraft's route of flight, when requested.

j. Whether or not an ELT signal has been heard or reported in the vicinity of the last known position.

k. Other pertinent information.

REFERENCE-

FAAO 7110.65, Responsibility, Para 10-1-4

FAAO 7110.65, Emergency Situations, Para 10-2-5

NOTE-

FSSs serve as the central points for collecting and disseminating information on an overdue or missing aircraft which is not on an IFR flight plan. Non-FSS ATC facilities that receive telephone calls or other inquiries regarding these flights shall refer these calls and inquiries to the appropriate AFSS/FSS.

10-3-3. INFORMATION TO BE FORWARDED TO RCC

EN ROUTE

When an aircraft is considered to be in emergency status or an IFR aircraft is overdue, the ARTCC shall alert the RCC and forward the following information, as available:

a. Facility and person calling.

b. Flight plan, including color of aircraft, if known.

c. Time of last transmission received, by whom, and frequency used.

d. Last position report and how determined.

e. Action taken by reporting facility and proposed action.

f. Number of persons on board.

g. Fuel status.

h. Facility working aircraft and frequency.

i. Last known position, estimated present position, and maximum range of flight of the aircraft based on remaining fuel and airspeed.

j. Position of other aircraft near aircraft's route of flight, when requested.

k. Whether or not an ELT signal has been heard or reported in the vicinity of the last known position.

l. Other pertinent information.

REFERENCE–

FAAO 7110.65, *Responsibility, Para 10–1–4*

FAAO 7110.65, *Emergency Situations, Para 10–2–5*

NOTE–

FSSs serve as the central points for collecting and disseminating information on an overdue or missing aircraft which is not on an IFR flight plan. Non-FSS ATC facilities that receive telephone calls or other inquiries regarding these flights shall refer these calls and inquiries to the appropriate AFSS/FSS.

10–3–4. ALNOT

EN ROUTE

a. In addition to routing to your regional office operations center, issue an ALNOT to all centers and Area B circuits, generally 50 miles on either side of the route of flight from the last reported position to destination. Include the original or amended flight plan, as appropriate, and the last known position of the aircraft. At the recommendation of the RCC or at your discretion, the ALNOT may be issued to cover the maximum range of the aircraft.

NOTE–

1. *An ALNOT must be issued before the RCC can begin search and rescue procedures.*

2. *Flight plan information on military aircraft is available at the FSS serving as a tie-in station for the departure or destination airport. FAA tie-in stations for airports in the continental U.S. are listed in Order 7350.7, Location Identifiers. In the Western-Pacific Region, tie-in stations are listed in regional publications entitled, “Flight Plan Routing and Airport Search Directory.” For flights with overseas departure points, the information is available through the destination FSS or the appropriate IFSS.*

b. Upon receipt of an INREQ or ALNOT, check the position records to determine whether the aircraft has contacted your facility. Notify the originator of the results or status of this check within one hour of the time the alert was received. Retain the alert in an active status, and immediately notify the originator of subsequent contact, until cancellation is received.

10–3–5. RESPONSIBILITY TRANSFER TO RCC

EN ROUTE

Transfer responsibility for further search to the RCC when one of the following occurs:

a. Thirty minutes have elapsed after the estimated aircraft fuel exhaustion time.

b. The aircraft has not been located within one hour after ALNOT issuance.

c. The ALNOT search has been completed with negative results.

10–3–6. AIRCRAFT POSITION PLOTS

Plot the flight path of the aircraft on a chart, including position reports, predicted positions, possible range of flight, and any other pertinent information. Solicit the assistance of other aircraft known to be operating near the aircraft in distress. Forward this information to the RCC or the ARTCC as appropriate.

10–3–7. ALNOT CANCELLATION

EN ROUTE

Cancel the ALNOT when the aircraft is located or the search is abandoned.

Section 4. Control Actions

10-4-1. TRAFFIC RESTRICTIONS

IFR traffic which could be affected by an overdue or unreported aircraft shall be restricted or suspended unless radar separation is used. The facility responsible shall restrict or suspend IFR traffic for a period of 30 minutes following the applicable time listed in subparagraphs a thru e:

- a. The time at which approach clearance was delivered to the pilot.
- b. The EFC time delivered to the pilot.
- c. The arrival time over the NAVAID serving the destination airport.
- d. The current estimate, either the control facility's or the pilot's, whichever is later, at:
 1. The appropriate en route NAVAID or fix, and
 2. The NAVAID serving the destination airport.
- e. The release time and, if issued, the clearance void time.

REFERENCE-

FAAO 7110.65, *Departure Restrictions, Clearance Void Times, Hold for Release, and Release Times, Para 4-3-4*

10-4-2. LIGHTING REQUIREMENTS

a. **EN ROUTE.** At nontower or non-FSS locations, request the airport management to light all runway lights, approach lights, and all other required airport lighting systems for at least 30 minutes before the ETA of the unreported aircraft until the aircraft has been located or for 30 minutes after its fuel supply is estimated to be exhausted.

b. **TERMINAL.** Operate runway lights, approach lights, and all other required airport lighting systems for at least 30 minutes before the ETA of the unreported aircraft until the aircraft has been located or for 30 minutes after its fuel supply is estimated to be exhausted.

REFERENCE-

FAAO 7110.65, *Emergency Lighting, Para 3-4-1*

10-4-3. TRAFFIC RESUMPTION

After the 30-minute traffic suspension period has expired, resume normal air traffic control if the operators or pilots of other aircraft concur. This concurrence must be maintained for a period of 30 minutes after the suspension period has expired.

REFERENCE-

FAAO 7110.65 *Departure Restrictions, Clearance Void Times, Hold for Release, and Release Times, Para 4-3-4*

10-4-4. COMMUNICATIONS FAILURE

Take the following actions, as appropriate, if two-way radio communications are lost with an aircraft:

NOTE-

1. When an IFR aircraft experiences two-way radio communications failure, air traffic control is based on anticipated pilot actions. Pilot procedures and recommended practices are set forth in the AIM, CFRs, and pertinent military regulations.

2. Should the pilot of an aircraft equipped with a coded radar beacon transponder experience a loss of two-way radio capability, the pilot can be expected to adjust the transponder to reply on Mode 3/A Code 7600.

a. In the event of lost communications with an aircraft under your control jurisdiction use all appropriate means available to reestablish communications with the aircraft. These may include, but not be limited to, emergency frequencies, NAVAIDs that are equipped with voice capability, FSS, Aeronautical Radio Incorporated (ARINC), etc.

NOTE-

1. ARINC is a commercial communications corporation which designs, constructs, operates, leases or otherwise engages in radio activities serving the aviation community. ARINC has the capability of relaying information to/from subscribing aircraft throughout the country.

2. Aircraft communications addressing and reporting system (ACARS) or selective calling (SELCAL) may be utilized to reestablish radio communications with suitably equipped aircraft. ACARS can be accessed by contacting the San Francisco ARINC communications center, watch supervisor, at 925-294-8297 and 800-621-0140. Provide ARINC the aircraft call sign, approximate location, and contact instructions. In order to utilize the SELCAL system, the SELCAL code for the subject aircraft must be known. If the SELCAL code is not contained in the remarks section

of the flight plan, contact the pertinent air carrier dispatch office to determine the code. Then contact the San Francisco ARINC communications center, watch supervisor, at 925-294-8297 and 800-621-0140. Provide ARINC the aircraft call sign, SELCAL code, approximate location, and contact instructions.

b. Broadcast clearances through any available means of communications including the voice feature of NAVAIDs.

NOTE-

1. *Some UHF equipped aircraft have VHF navigation equipment and can receive 121.5 MHz.*

2. *“Any available means” includes the use of FSS and ARINC.*

REFERENCE-

FAAO 7110.65, Clearance Prefix, Para 4-2-2

c. Attempt to re-establish communication by having the aircraft use its transponder or make turns to acknowledge clearances and answer questions. Request any of the following in using the transponder:

1. Request the aircraft to reply Mode 3/A “IDENT.”

2. Request the aircraft to reply on **Code 7600** or if already on **Code 7600**, the appropriate stratum code.

3. Request the aircraft to change to “stand-by” for sufficient time for you to be sure that the lack of a target is the result of the requested action.

PHRASEOLOGY-

REPLY NOT RECEIVED, (appropriate instructions).

(Action) OBSERVED, (additional instructions/information if necessary).

d. Broadcast a clearance for the aircraft to proceed to its filed alternate airport at the MEA if the aircraft operator concurs.

REFERENCE-

FAAO 7110.65, Radio Failure, Para 5-2-8

FAAO 7110.65, IFR Military Training Routes, Para 9-3-7

Section 5. Miscellaneous Operations

10-5-1. NAVY FLEET SUPPORT MISSIONS

When you receive information concerning an emergency to a U.S. Navy “Special Flight Number” aircraft, do the following:

a. Handle Navy Fleet Support Mission aircraft as follows:

1. EN ROUTE. Relay immediately, via collect telephone call, all pertinent information to Fleet Operations Control at Norfolk, Virginia, telephone 804-444-6602.

2. TERMINAL. Inform the nearest center of all the pertinent information.

b. Relay the words “Special Flight Number” followed by the number given as part of the routine IFR flight information.

c. Honor pilot requests for changes to route, altitude, and destination, whenever possible.

10-5-2. EXPLOSIVE CARGO

TERMINAL

When you receive information that an emergency landing will be made with explosive cargo aboard, inform the pilot of the safest or least congested airport areas. Relay the explosive cargo information to:

a. The emergency equipment crew.

b. The airport management.

c. The appropriate military agencies, when requested by the pilot.

Section 6. Oceanic Emergency Procedures

10-6-1. APPLICATION

The procedures in this section are to be used solely in oceanic airspace.

10-6-2. PHASES OF EMERGENCY

Emergency phases are described as follows:

a. Uncertainty phase (INCERFA). When there is concern about the safety of an aircraft or its occupants, an INCERFA exists:

1. When communication from an aircraft has not been received within 30 minutes after the time a communication should have been received or after the time an unsuccessful attempt to establish communication with such aircraft was first made, whichever is earlier; or

2. When an aircraft fails to arrive within 30 minutes after the time of arrival last estimated by the pilot or by the ATC units, whichever is later.

b. Alert phase (ALERFA). When there is apprehension about the safety of an aircraft and its occupants, an ALERFA exists:

1. Following the uncertainty phase when subsequent attempts to establish communications with the aircraft, or inquiries to other relevant sources have failed to reveal any information about the aircraft; or

2. When information has been received which indicates that the operating efficiency of the aircraft has been impaired but not to the extent that a forced landing is likely; or

3. When communication from an aircraft has not been received within 60 minutes after the time a communication should have been received or after the time an unsuccessful attempt to establish communication with such aircraft was first made, whichever is earlier.

c. Distress phase (DETRESFA). When there is reasonable certainty that the aircraft and its occupants are threatened by grave and imminent danger, a DETRESFA exists:

1. Following the alert phase when further attempts to establish communications with the aircraft and more widespread inquiries are unsuccessful; or

2. When the fuel on board is considered to be exhausted or to be insufficient for the aircraft to reach safety; or

3. When information is received which indicates that the operating efficiency of the aircraft has been impaired to the extent that a forced landing is likely; or

4. When information is received or it is reasonably certain that the aircraft is about to make or has made a forced landing.

10-6-3. ALERTING SERVICE AND SPECIAL ASSISTANCE

a. Provide alerting service to:

1. All aircraft receiving ATC service;

2. All other aircraft which have filed a flight plan or which are otherwise known to the ATC unit; and

3. Any aircraft known or believed to be the subject of unlawful interference.

b. When alerting service is required, the responsibility for coordinating such service shall, unless otherwise established by letter of agreement, rest with the facility serving the FIR or CTA:

1. Within which the aircraft was flying at the time of last air-ground radio contact; or

2. Which the aircraft was about to enter if the last air-ground contact was established at or close to the boundary; or

3. Within which the point of destination is located if the aircraft:

(a) Was not equipped with suitable two-way radio communications equipment; or

(b) Was not under obligation to transmit position reports.

REFERENCE-

FAAO 7110.65, Chapter 8, Section 2, Coordination.

c. The responsible Area Control Center (ACC) shall serve as the control point for:

1. Collecting all information relevant to a state of emergency of an aircraft;

2. Forwarding that information to the appropriate RCC; and

3. Coordinating with other facilities concerned.

d. The responsibility of the ACC to provide alerting service for military aircraft may be waived upon a written or recorded request from a military agency. In this case, the military request must state that the military agency assumes full responsibility for their aircraft while the aircraft are operating in the oceanic airspace.

e. Responsibility to provide alerting service for flight operations conducted under the “due regard” or “operational” prerogative of military aircraft is assumed by the military. When “due regard” operations are scheduled to end with aircraft filed under ICAO procedures, the ACC may, if specified in a letter of agreement, assume responsibility for alerting service at proposed time filed.

f. In the event of INCERFA, ALERFA, or DETRESFA, notify the following:

1. When practicable, the aircraft operator.

2. The appropriate RCC.

3. Aeronautical stations having en route communications guard responsibilities at the point of departure, along or adjacent to the route of flight, and at the destination.

4. ACCs having jurisdiction over the proposed route of flight from the last reported position to the destination airport.

g. INCERFA, ALERFA, and DETRESFA messages shall include the following information, if available, in the order listed:

1. INCERFA, ALERFA, or DETRESFA according to the phase of the emergency.

2. Agency and person originating the message.

3. Nature of the emergency.

4. Significant flight plan information.

5. The air traffic unit which made the last radio contact, the time, and the frequency used.

6. The aircraft’s last position report, how it was received, and what facility received it.

7. Color and distinctive marks of aircraft.

8. Any action taken by reporting office.

9. Other pertinent remarks.

h. An INCERFA phase ends with the receipt of any information or position report on the aircraft. Cancel the INCERFA by a message addressed to the same stations as the INCERFA message.

1. An ALERFA ends when:

(a) Evidence exists that would ease apprehension about the safety of the aircraft and its occupants; or

(b) The concerned aircraft lands. Cancel the ALERFA message by a message addressed to the same stations as the ALERFA message.

2. A DETRESFA ends when the:

(a) Aircraft successfully lands; or

(b) RCC advises of a successful rescue; or

(c) RCC advises of termination of SAR activities. Cancel the DETRESFA by a message addressed to the same stations as the DETRESFA message.

i. A separate chronological record should be kept on each ALERFA and DETRESFA together with a chart which displays the projected route of the aircraft, position reports received, route of interceptor aircraft, and other pertinent information.

10-6-4. INFLIGHT CONTINGENCIES

a. If an aircraft over water requests weather, sea conditions, ditching information, and/or assistance from surface vessels, or if the controller feels that this information may be necessary for aircraft safety, it should be requested from the RCC. Also, an appropriate AMVER SURPIC should be asked for if requested by the aircraft or deemed beneficial by control personnel.

NOTE-

The AMVER Center can deliver, in a matter of minutes, a SURPIC of vessels in the area of a SAR incident, including their predicted positions and their characteristics.

b. In all cases of aircraft ditching, the airspace required for SAR operations shall be determined by the RCC. The ACC shall block that airspace until the RCC advises the airspace is no longer required. An International Notice to Airmen (NOTAM) shall be issued describing the airspace affected.

c. The following actions will be taken in the event an aircraft must make an emergency descent:

1. In the event an aircraft requests an emergency descent:

(a) Issue a clearance to the requested altitude if approved separation can be provided.

(b) Advise the aircraft of the traffic, and request its intentions if traffic prevents an unrestricted descent.

PHRASEOLOGY–

ATC ADVISES (aircraft identification) UNABLE TO APPROVE UNRESTRICTED DESCENT.

TRAFFIC (traffic information).

REQUEST INTENTIONS.

2. In the event an aircraft is making or will make an emergency descent without a clearance:

(a) Advise other aircraft of the emergency descent.

PHRASEOLOGY–

ATC ADVISES (aircraft identification/all aircraft) BE ALERT FOR EMERGENCY DESCENT IN THE VICINITY OF (latitude/longitude) FROM (altitude/FL) TO (altitude/FL).

(b) Advise other aircraft when the emergency descent is complete.

PHRASEOLOGY–

(Aircraft identification/all aircraft) EMERGENCY DESCENT AT (location) COMPLETED.

3. Upon notification that an aircraft is making an emergency descent through other traffic, take action immediately to safeguard all aircraft concerned.

4. When appropriate, broadcast by ATC communications, by radio navigation aids, and/or through aeronautical communication stations/services an emergency message to all aircraft in the vicinity of the descending aircraft. Include the following information:

- (a) Location of emergency descent.
- (b) Direction of flight.
- (c) Type aircraft.
- (d) Route if appropriate.
- (e) Altitude vacated.
- (f) Other information.

EXAMPLE–

“Attention all aircraft in the vicinity of Trout, a northbound D–C Ten on A–T–S Route Alfa Seven Hundred is making an emergency descent from flight level three three zero.” (Repeat as you deem appropriate.)

5. If traffic conditions permit, provide traffic information to the affected aircraft.

6. Immediately after an emergency broadcast or traffic information has been made, issue appropriate clearances or instructions, as necessary, to all aircraft involved.

10–6–5. SERVICES TO RESCUE AIRCRAFT

a. Provide standard IFR separation between the SAR and the aircraft in distress, except when visual or radar contact has been established by the search and rescue aircraft and the pilots of both aircraft concur, IFR separation may be discontinued.

b. Clear the SAR aircraft to a fixed clearance limit rather than to the aircraft in distress, which is a moving fix. Issue route clearances that are consistent with that of the distressed aircraft.

c. Advise the rescue aircraft, as soon as practicable, of any factors that could adversely affect its mission; e.g., unfavorable weather conditions, anticipated problems, the possibility of not being able to approve an IFR descent through en route traffic, etc.

d. Advise the appropriate rescue agency of all pertinent information as it develops.

e. Forward immediately any information about the action being taken by the RCC, other organizations, or aircraft to the aircraft concerned.

f. Advise the aircraft operator of the current status of the SAR operation as soon as practicable.

g. Since prompt, correct, and complete information is the key to successful rescue operations, ensure that this information is swiftly and smoothly supplied to those organizations actively engaged in rescue operations.

Section 7. Ground Missile Emergencies

10-7-1. INFORMATION RELAY

When you receive information concerning a ground missile emergency, notify other concerned facilities and take action to have alerting advisories issued by:

a. EN ROUTE. Air carrier company radio stations for each VFR company aircraft which is or will be operating in the vicinity of the emergency.

b. EN ROUTE. FSSs adjacent to the emergency location.

c. TERMINAL. Relay all information concerning a ground missile emergency to the ARTCC within whose area the emergency exists and disseminate as a NOTAM.

REFERENCE-

P/CG Term- Notice to Airmen.

10-7-2. IFR AND SVFR MINIMA

Reroute IFR and SVFR aircraft as necessary to avoid the emergency location by one of the following minima, or by greater minima when suggested by the notifying official:

a. Lateral separation- *1 mile* between the emergency location and either of the following:

1. An aircraft under radar control and the emergency location which can be accurately determined by reference to the radar scope.

2. The airspace to be protected for the route being flown.

b. Vertical separation- *6,000 feet* above the surface over the emergency location.

10-7-3. VFR MINIMA

Advise all known VFR aircraft which are, or will be, operating in the vicinity of a ground missile emergency, to avoid the emergency location by 1 mile laterally or 6,000 feet vertically, or by a greater distance or altitude, when suggested by the notifying official.

10-7-4. SMOKE COLUMN AVOIDANCE

Advise all aircraft to avoid any observed smoke columns in the vicinity of a ground missile emergency.

10-7-5. EXTENDED NOTIFICATION

EN ROUTE

When reports indicate that an emergency will exist for an extended period of time, a Notice to Airmen may be issued.

Chapter 11. Traffic Management Procedures

Section 1. General

11-1-1. DUTY RESPONSIBILITY

a. The traffic management system mission is to balance air traffic demand with system capacity to ensure the maximum efficient utilization of the NAS.

b. It is recognized that the ATCS is integral in the execution of the traffic management mission.

NOTE-

Complete details of traffic management initiatives and programs can be found in FAAO 7210.3, Facility Operation and Administration.

11-1-2. DUTIES AND RESPONSIBILITIES

a. Supervisory Traffic Management Coordinator-in-Charge (STMCIC) shall:

1. Ensure that an operational briefing is conducted at least once during the day and evening shifts. Participants shall include, at a minimum, the STMCIC, Operations Supervisors (OS), Traffic Management Coordinator(s) (TMC), and other interested personnel as designated by facility management. Discussions at the meeting should include meteorological conditions (present and forecasted), staffing, equipment status, runways in use, AAR and traffic management initiatives (present and anticipated).

2. Assume responsibility for TMC duties when not staffed.

3. Ensure that traffic management initiatives are carried out by Supervisory Traffic Management Coordinator-in-Charge (STMCIC).

4. Where authorized, perform URET data entries to keep the activation status of designated URET Airspace Configuration Elements current.

5. Perform assigned actions in the event of a URET outage or degradation, in accordance with the requirements of FAA Order 7210.3, Facility Operation and Administration, and as designated by facility directive.

6. Ensure changes to restrictions based on the Restrictions Inventory and Evaluation are implemented in a timely manner.

b. OS shall:

1. Keep the TMU and affected sectors apprised of situations or circumstances that may cause congestion or delays.

2. Coordinate with the TMU and ATCSs to develop appropriate traffic management initiatives for sectors and airports in their area of responsibility.

3. Continuously review traffic management initiatives affecting their area of responsibility and coordinate with TMU for extensions, revisions, or cancellations.

4. Ensure that traffic management initiatives are carried out by ATCSs.

5. Where authorized, perform URET data entries to keep the activation status of designated URET Airspace Configuration Elements current.

6. Perform assigned actions in the event of a URET outage or degradation, in accordance with the requirements of FAA Order 7210.3, Facility Operation and Administration, and as designated by facility directive.

7. Ensure changes to restrictions based on the Restrictions Inventory and Evaluation are implemented in a timely manner.

c. ATCSs shall:

1. Ensure that traffic management initiatives and programs are enforced within their area of responsibility. Traffic management initiatives and programs do not have priority over maintaining:

(a) Separation of aircraft.

(b) Procedural integrity of the sector.

2. Keep the OS and TMU apprised of situations or circumstances that may cause congestion or delays.

3. Continuously review traffic management initiatives affecting their area of responsibility and coordinate with OS and TMU for extensions, revisions, or cancellations.

4. Where authorized, perform URET data entries to keep the activation status of designated URET Airspace Configuration Elements current.

5. Perform assigned actions in the event of a URET outage or degradation, in accordance with the requirements of FAA Order 7210.3, Facility Operation and Administration, and as designated by facility directive.

Chapter 12. Canadian Airspace Procedures

Section 1. General Control

12-1-1. APPLICATION

Where control responsibility within Canadian airspace has been formally delegated to the FAA by the Transport Canada Aviation Group, apply basic FAA procedures except for the Canadian procedures contained in this chapter.

NOTE-

In 1985, the U.S. and Canada established an agreement recognizing the inherent safety of the ATC procedures exercised by the other country. This agreement permits the use of ATC procedures of one country when that country is exercising ATC in the airspace over the territory of the other country insofar as they are not inconsistent with, or repugnant to, the laws and regulations or unique operational requirements of the country over whose territory such airspace is located. Accordingly, this chapter was revised to include only those Canadian procedures that must be used because of a Canadian regulatory or unique operational requirement.

12-1-2. AIRSPACE CLASSIFICATION

a. Class A airspace. Controlled airspace within which only IFR flights are permitted. Airspace designated from the base of all controlled high level airspace up to and including FL 600.

b. Class B airspace. Controlled airspace within which only IFR and Controlled VFR (CVFR) flights are permitted. Includes all controlled low level airspace above 12,500 feet ASL or at and above the minimum en route IFR altitude, (whichever is higher) up to but not including 18,000 feet ASL. ATC procedures pertinent to IFR flights shall be applied to CVFR aircraft.

NOTE-

The CVFR pilot is responsible to maintain VFR flight and visual reference to the ground at all times.

c. Class C airspace. Controlled airspace within which both IFR and VFR flights are permitted, but VFR flights require a clearance from ATC to enter.

d. Class D airspace. Controlled airspace within which both IFR and VFR flights are permitted, but VFR flights do not require a clearance from ATC to enter, however, they must establish two-way communications with the appropriate ATC agency prior to entering the airspace.

e. Class E airspace. Airspace within which both IFR and VFR flights are permitted, but for VFR flight there are no special requirements.

f. Class F airspace. Airspace of defined dimensions within which activities must be confined because of their nature, or within which limitations are imposed upon aircraft operations that are not a part of those activities, or both. Special use airspace may be classified as Class F advisory or Class F restricted.

g. Class G airspace. Uncontrolled airspace within which ATC has neither the authority or responsibility for exercising control over air traffic.

12-1-3. ONE THOUSAND-ON-TOP

Clear an aircraft to maintain “at least 1,000 feet-on-top” in lieu of “VFR-on-top,” provided:

a. The pilot requests it.

NOTE-

It is the pilot’s responsibility to ensure that the requested operation can be conducted at least 1,000 feet above all cloud, haze, smoke, or other formation, with a flight visibility of 3 miles or more. A pilot’s request can be considered as confirmation that conditions are adequate.

b. The pilot will not operate within Class A or Class B airspace.

12-1-4. SEPARATION

Apply a lateral, longitudinal, or vertical separation minimum between aircraft operating in accordance with an IFR or CVFR clearance, regardless of the weather conditions.

12-1-5. DEPARTURE CLEARANCE/COMMUNICATION FAILURE

a. Base controller action regarding radio failures in Canadian airspace on the requirement for pilots to comply with Canadian Airspace Regulations, which are similar to 14 CFR Section 91.185; however, the following major difference shall be considered when planning control actions. Except when issued alternate radio failure instructions by ATC, pilots will adhere to the following: If flying a turbine-powered (turboprop or turbojet) aircraft and cleared on departure to a point other than the destination, proceed to the destination airport in accordance with the flight plan, maintaining the last assigned altitude or flight level or the minimum en route IFR altitude, whichever is higher, until 10 minutes beyond the point specified in the clearance (clearance limit), and then proceed at altitude(s) or flight level(s) filed in the flight plan. When the aircraft will enter U.S. airspace within 10 minutes after passing the clearance limit, the climb to the flight planned border crossing altitude is to be commenced at the estimated time of crossing the Canada/U.S. boundary.

12-1-6. PARACHUTE JUMPING

Do not authorize parachute jumping without prior permission from the appropriate Canadian authority.

NOTE-

Canadian regulations require written authority from the Ministry of Transport.

12-1-7. SPECIAL VFR (SVFR)

NOTE-

Pilots do not have to be IFR qualified to fly SVFR at night, nor does the aircraft have to be equipped for IFR flight.

a. Within a control zone where there is an airport controller on duty, approve or refuse a pilot's request for SVFR on the basis of current or anticipated IFR traffic only. If approved, specify the period of time during which SVFR flight is permitted.

b. Within a control zone where there is no airport controller on duty, authorize or refuse an aircraft's request for SVFR on the basis of:

- 1.** Current or anticipated IFR traffic, and
- 2.** Official ceiling and visibility reports.

c. Canadian SVFR weather minimums for:

- 1.** Aircraft other than helicopters. Flight visibility (ground visibility when reported) 1 mile.
- 2.** Helicopters. Flight visibility (ground visibility when available) 1/2 mile.

Chapter 13. Decision Support Tools

Section 1. User Request Evaluation Tool (URET) – En Route

13-1-1. DESCRIPTION

a. URET, a decision support technology and component of the Free Flight Program, is utilized in the en route environment and is located at the Radar Associate (RA) position at an operational sector. The purpose of the tool is the prediction of conflicts between aircraft and between aircraft and special use or designated airspace, and it also provides trial planning and enhanced flight data management capabilities.

b. URET is designed to enhance the efficiency of the Sector Team by providing decision support in the prediction and resolution of potential conflicts, and, as a result, allowing controllers more latitude in other tasks, such as responding to user requests. Further, the use of the tool could provide increased system safety, decreased system delays, and increased system flexibility, predictability, productivity, and user access.

c. URET predicts conflicts up to 20 minutes in advance using flight plan, forecast winds, aircraft performance characteristics, and track data to derive expected aircraft trajectories. URET supports early identification and resolution of predicted conflicts and the evaluation of user requests, and it is to be used by the sector team in performing their strategic planning responsibilities.

13-1-2. CONFLICT DETECTION AND RESOLUTION

a. Actively scan URET information for predicted alerts.

b. When a URET alert is displayed, evaluate the alert and take appropriate action as early as practical, in accordance with duty priorities.

c. Prioritize the evaluation and resolution of URET alerts to ensure the safe, expeditious, and efficient flow of air traffic.

NOTE-

URET alerts are based on radar separation standards. Caution should be used when situations include nonstandard formations.

d. When a URET alert is displayed and when sector priorities permit, give consideration to the following in determining a solution:

1. Solutions that involve direct routing, altitude changes, removal of a flight direction constraint (i.e., inappropriate altitude for direction of flight), and/or removal of a static restriction for one or more pertinent aircraft.

2. Impact on surrounding sector traffic and complexity levels, flight efficiencies, and user preferences.

13-1-3. TRIAL PLANNING

a. When URET is operational at the sector and when sector priorities permit, use the trial plan capability to evaluate:

1. Solutions to predicted conflicts.

2. The feasibility of granting user requests.

3. The feasibility of removing a flight direction constraint (i.e., inappropriate altitude for direction of flight) for an aircraft.

4. The feasibility of removing a static restriction for an aircraft.

13-1-4. URET-BASED CLEARANCES

When the results of a trial plan based upon a user request indicate the absence of alerts, every effort should be made to grant the user request, unless the change is likely to adversely affect operations at another sector.

13-1-5. THE AIRCRAFT LIST (ACL) AND FLIGHT DATA MANAGEMENT

a. The ACL shall be used as the sector team's primary source of flight data.

b. When URET is operational, sector teams shall post flight progress strips for any nonradar flights.

c. When URET is operational, sector teams shall post any flight progress strip(s) that are deemed necessary for safe or efficient operations. The sector team shall comply with all applicable facility directives to maintain posted flight progress strips.

NOTE-

Cases in which an operational advantage may be realized include, but are not limited to aircraft that cannot be expected to remain in radar contact, aircraft in hold, and emergencies.

13-1-6. RECORDING OF CONTROL DATA

a. All control information not otherwise recorded via automation recordings or voice recordings shall be manually recorded using approved methods.

b. Control information may be entered in the free text area and shall be used for reference purposes only.

c. Data required to be entered into the free text area shall be designated in a facility directive.

13-1-7. ACKNOWLEDGEMENT OF AUTOMATED NOTIFICATION

a. Remove Inappropriate Altitude for Direction of Flight coding only after any required coordination has been completed.

b. Remove Unsuccessful Transmission Message (UTM) coding only after appropriate coordination has been completed.

c. Send/acknowledge Host Embedded Route Text (HERT) coding only after the appropriate clearance has been issued to the pilot or otherwise coordinated.

d. Remove Expect Departure Clearance Time (EDCT) coding only after the EDCT has been issued to the pilot.

e. Remove ATC Preferred Route (APR) coding only after the route has been checked and any required action has been completed.

NOTE-

If coding is prematurely removed and the control of the aircraft is transferred prior to completing the appropriate action, the next sector will not receive the necessary APR notification.

13-1-8. CURRENCY OF TRAJECTORY INFORMATION

a. The sector team shall perform automation entries in a timely manner.

NOTE-

1. Conflict probe accuracy requires timely updates of data used to model each flight's trajectory. If this data is not current, the aircraft entries and notification of probe results for surrounding sectors and facilities, as well as the subject sector, may be misleading.

2. Data used to model an individual aircraft's trajectory includes route of flight, assigned and interim altitudes, application/removal of an adapted restriction for that flight, and aircraft type.

b. An exception to the requirement to enter or update interim altitudes may be authorized for certain ARTCC sectors if explicitly defined in an appropriate facility directive.

NOTE-

URET accuracy in assigning alert notification is dependent upon entry/update of a flight's interim altitude.

13-1-9. DELAY REPORTING

a. Adhere to all applicable delay reporting directives while URET is operational.

b. Delay information shall be recorded either on available flight progress strips or on facility approved forms.

13-1-10. OVERDUE AIRCRAFT

Upon receipt of the URET overdue aircraft notification take appropriate actions set forth in Chapter 10, Section 3, Overdue Aircraft.

NOTE-

URET overdue aircraft notification is based on radar track data. Updating an aircraft's route of flight will remove the overdue aircraft notification.

13-1-11. USE OF GRAPHICS PLAN DISPLAY (GPD)

a. Graphic depictions of flight trajectories may be used only to aid in situational awareness and strategic planning.

b. Do not use trajectory-based positions as a substitute for radar track position.

c. Do not use trajectory-based altitude in lieu of Mode C for altitude confirmation.

d. Do not use the GPD for radar identification, position information, transfer of radar identification, radar separation, correlation, or pointouts.

13-1-12. FORECAST WINDS

In the event that current forecast wind data is not available, continue use of URET with appropriate recognition that alert data may be affected.

13-1-13. INTERFACILITY CONNECTIVITY

In the event of a loss of connectivity to a neighboring URET system, continue use of URET with appropriate recognition that alert data may be affected.

13-1-14. PRIMARY RDP/FDP OUTAGES

In the event of a primary RDP/FDP outage, URET data may be used to support situational awareness while the facility transitions to the backup RDP or nonradar procedures.

NOTE-

Without primary system input, URET data cannot be updated and becomes stale.

Section 2. Ocean21 – Oceanic

The following procedures are applicable to the operation of the Ocean21 Oceanic Air Traffic Control (ATC) System.

13-2-1. DESCRIPTION

a. The Ocean21 ATC System is utilized in designated enroute/oceanic airspace. Ocean21 includes both surveillance and flight data processing, which provides the controllers with automated decision support tools to establish, monitor and maintain separation between aircraft, and aircraft to airspace and terrain.

b. Ocean21 capabilities include:

1. MEARTS based radar surveillance processing.
2. Conflict Prediction and Reporting.
3. Automatic Dependent Surveillance–Broadcast (ADS–B).
4. Automatic Dependent Surveillance–Contract (ADS–C).
5. Controller Pilot Data Link Communications (CPDLC).
6. ATC Interfacility Data Communications (AIDC).
7. Additional Decision Support Tools used primarily for situational awareness.
8. Electronic Flight Data including Electronic Flight Strips.

13-2-2. CONFLICT DETECTION AND RESOLUTION

The controller shall use the most accurate information available to initiate, monitor, and maintain separation.

a. Apply the following procedures in airspace where conflict probe is being utilized as a decision support tool:

1. Conflict Probe Results.

(a) Controllers shall assume that the conflict probe separation calculations are accurate.

(b) Unless otherwise prescribed in subpara a3, controllers shall utilize the results from conflict probe to initiate and maintain the prescribed separation minima.

2. Conflict Resolution.

(a) When a controller is alerted to a conflict, which will occur in his/her sector, take the appropriate action to resolve the conflict.

(b) The controller responsible for resolving a conflict shall evaluate the alert and take appropriate action as early as practical, in accordance with duty priorities, alert priority, and operational considerations.

(c) Unless otherwise specified in facility directives, the controller shall take immediate action to resolve any “red” conflicts.

3. Overriding Conflict Probe.

(a) Controllers shall not override conflict probe except for the following situations:

(1) The application of a separation standard not recognized by conflict probe listed in subpara a8(a), or as identified by facility directive.

(2) When action has been taken to resolve the identified conflict and separation has been ensured, or

(3) Control responsibility has been delegated to another sector or facility, or

(4) Other situations as specified in facility directives.

(b) Controllers shall continue to ensure that separation is maintained until the overridden conflict is resolved.

4. Use of Probe when Issuing Clearances. Utilize conflict probe results when issuing a clearance to ensure that any potential conflict has been given thorough consideration.

5. Use of Probe when Accepting Manual Transfers. Prior to manually accepting an aircraft transfer from an external facility ensure that the coordinated flight profile is accurately entered, conflict probe initiated and, if necessary, action is taken to resolve any potential conflicts.

6. Trial Probe. The controller can utilize trial probe to assess whether there are any potential conflicts with a proposed clearance or when performing manual coordination.

NOTE–

Once initiated, trial probe does not take into account any changes made to the proposed profile or to any other flight profile in the system. It is an assessment by conflict probe of the current situation at the time the controller enters the trial probe. A trial probe does not alleviate the controller from performing a conflict probe when issuing a clearance or accepting a transfer.

7. System Unable to Perform Conflict Probe for a Specific Aircraft.

(a) If a flight's profile becomes corrupted, conflict probe may not be able to correctly monitor separation for that flight. Take the necessary steps to correct an aircraft's flight plan when conflict probe could not be performed.

(b) In addition, after verifying flight plan data accuracy, utilize other decision support tools to establish and maintain the appropriate separation minima until such time that conflict probe can be utilized.

8. Conflict Probe Limitations.

(a) Conflict Probe does not support the following separation minima:

(1) Subpara 8-4-2a2 – Nonintersecting paths.

(2) Subpara 8-4-2d – Intersecting flight paths with variable width protected airspace.

(3) Subpara 8-4-3a – Reduction of Route Protected Airspace, below FL 240.

(4) Subpara 8-4-3b – Reduction of Route Protected Airspace, at and above FL 240.

(5) Subpara 8-4-4a1 – Same NAVAID: VOR/VORTAC/TACAN.

(6) Subpara 8-4-4a2 – Same NAVAID: NDB.

(7) Subpara 8-4-4c – Dead Reckoning.

(8) Para 8-5-4 – Same Direction.

(9) Para 8-6-3 – Temporary Moving Airspace Reservations.

(10) Para 8-8-5 – VFR Climb and Descent.

(11) ZAN waiver 97-0-036 (30/40 DME).

b. Additional Decision Support Tools: These support tools include: range/bearing, time of passing, intercept angle, the aircraft situation display (ASD) and electronic flight data.

1. The results provided by these additional decision support/controller tools can be used by the controller for maintaining situational awareness and monitoring flight profile information, and for establishing and maintaining separation standards not supported by probe, or when probe is unavailable.

2. Under no circumstances shall the controller utilize any of the additional decision support tools to override probe results when the applicable separation standard is supported by probe and none of the other conditions for overriding probe apply.

13-2-3. INFORMATION MANAGEMENT

a. Currency of Information: The sector team is responsible for ensuring that manually entered data is accurate and timely. Ensure that nonconformant messages are handled in a timely manner and that the flight's profile is updated as necessary.

NOTE–

Conflict probe accuracy requires timely updates of data used to model each flight's trajectory. If this data is not current, the aircraft flight profile and probe results may be misleading.

b. Data Block Management.

1. Ensure that the data block reflects the most current flight information and controller applied indicators as specified in facility directives.

2. Ensure that appropriate and timely action is taken when a special condition code is indicated in the data block.

c. Electronic Flight Strip Management.

1. Electronic flight strips shall be maintained in accordance with facility directives and the following:

(a) Annotations. Ensure that annotations are kept up to date.

(b) Reduced Separation Flags. Ensure the flags listed below are selected appropriately for each flight:

(1) M– Mach Number Technique (MNT).

(2) R– Reduced MNT.

(3) D– Distance–based longitudinal.

(4) W– Reduced Vertical Separation Minimum (RVSM).

(c) Degraded RNP. Select when an aircraft has notified ATC of a reduction in navigation capability that affects the applicable separation minima.

(d) Restrictions. Ensure restrictions accurately reflect the cleared profile.

d. Queue Management.

1. Manage all sector and coordination queues in accordance with the appropriate message priority and the controller’s priority of duties.

2. In accordance with facility directives, ensure that the messages directed to the error queue are processed in a timely manner.

e. Window/List Management.

1. Ensure that the situation display window title bar is not obscured by other windows and/or lists.

NOTE–
The title bar changes color to denote when priority information on the ASD is being obscured or is out of view.

2. In accordance with facility directives, ensure that designated windows and/or lists are displayed at all times.

13–2–4. CONTROLLER PILOT DATA LINK COMMUNICATIONS (CPDLC)

a. Means of communication.

1. When CPDLC is available and CPDLC connected aircraft are operating outside of VHF coverage, CPDLC shall be used as the primary means of communication.

2. Voice communications may be utilized for CPDLC aircraft when it will provide an operational advantage and/or when workload or equipment capabilities demand.

3. When CPDLC is being utilized, a voice backup shall exist (e.g., HF, SATCOM, Third party).

4. When a pilot communicates via CPDLC, the response should be via CPDLC.

5. To the extent possible, the CPDLC message set should be used in lieu of free text messages.

NOTE–

The use of the CPDLC message set ensures the proper “closure” of CPDLC exchanges.

b. Transfer of Communications to the Next Facility.

1. When the receiving facility is capable of CPDLC communications, the data link transfer is automatic and is accomplished within facility adapted parameters.

2. When a receiving facility is not CPDLC capable, the transfer of communications shall be made in accordance with local directives and Letters of Agreement (LOAs).

c. Abnormal conditions.

1. If any portion of the automated transfer fails, the controller should attempt to initiate the transfer manually. If unable to complete the data link transfer, the controller should advise the pilot to log on to the next facility and send an End Service (EOS) message.

2. If CPDLC fails, voice communications shall be utilized until CPDLC connections can be reestablished.

3. If the CPDLC connection is lost on a specific aircraft, the controller should send a connection request message (CR1) or advise the pilot via backup communications to log on again.

4. If CPDLC service is to be canceled, the controller shall advise the pilot as early as possible to facilitate a smooth transition to voice communications. Workload permitting, the controller should also advise the pilot of the reason for the termination of data link.

5. Assume that all unanswered CPDLC messages have not been delivered. On initial voice contact with aircraft, preface the message with the following:

PHRASEOLOGY–

(Call Sign) CPDLC Failure, (message).

13-2-5. COORDINATION

In addition to the requirements set forth in Chapter 8, Offshore/Oceanic Procedures, Section 2, Coordination, automated coordination shall constitute complete coordination between Ocean21 sectors, both internally and between sectors across adjacent Ocean21 facilities, except:

a. When the aircraft is in conflict with another in the receiving sector, or

b. When otherwise specified in facility directives or LOA.

13-2-6. TEAM RESPONSIBILITIES – MULTIPLE PERSON OPERATION

a. When operating in a multiple controller operation at a workstation, ensure all ATC tasks are completed according to their priority of duties.

b. Multiple controller operation shall be accomplished according to facility directives.

Appendix A. Aircraft Information

TYPE ENGINE ABBREVIATIONS

P	piston
T	turboprop
J	jet

CLIMB AND DESCENT RATES

Climb and descent rates based on average en route climb/descent profiles at median weight between maximum gross takeoff and landing weights.

SRS

SRS means “same runway separation;” categorization criteria is specified in para 3-9-6, Same Runway Separation.

MANUFACTURERS

Listed under the primary manufacturer are other aircraft manufacturers who make versions of some of the aircraft in that group.

AIRCRAFT WEIGHT CLASSES

a. Heavy. Aircraft capable of takeoff weights of more than 255,000 pounds whether or not they are operating at this weight during a particular phase of flight.

NOTE-

** Denotes single-piloted military turbojet aircraft or aircraft to receive the same procedural handling as a single-piloted military turbojet aircraft.*

**** Denotes amphibian aircraft.*

+ Denotes aircraft weighing between 12,500 lbs. and 41,000 lbs. For Class B Airspace rules, these aircraft are “large, turbine-enginepowered aircraft.”

b. Large. Aircraft of more than 41,000 pounds, maximum certificated takeoff weight, up to 255,000 pounds.

c. Small. Aircraft of 41,000 pounds or less maximum certificated takeoff weight.

LAND AND HOLD SHORT OPERATIONS (LAHSO) AIRCRAFT GROUP AND DISTANCE MINIMA

FAA Order 7110.118, Land and Hold Short Operations, includes procedures and conditions for conducting land and hold short operations at designated airports. Appendix 1 to Order 7110.118 groups certain aircraft according to available landing distance for LAHSO operations. Aircraft group information for the purposes of Order 7110.118 is incorporated in this Appendix under Performance Information.

STAGE 3 AIRCRAFT DESIGNATORS

Stage 3 aircraft designators such as B72Q, B73Q, DC8Q, DC9Q may only be used within the U.S. These designators will not be recognized in Canadian airspace or any other airspace outside the U.S. These special Stage 3 aircraft designators will be eliminated in the near future. Operators using the Stage 3 designators should begin using the appropriate aircraft type designator within U.S. airspace as soon as practical.

TBL A-1
Land and Hold Short Operations (LAHSO)
Aircraft Group/Distance Minima

	Sea Level -999	1,000- 1,999	2000- 2,999	3000- 3,999	4000- 4,999	5000- 5,999	6000- 6,999	7000- 7,000
Group 1	2500	2550	2600	2650	2700	2750	2800	2850
Group 2 & Below	3000	3050	3100	3150	3200	3250	3300	3500
Group 3 & Below	3500	3550	3600	3650	3700	3750	3800	3850
Group 4 & Below	4000	4050	4100	4150	4200	4250	4300	4350
Group 5 & Below	4500	4550	4600	4650	4700	4750	4800	4850
Group 6 & Below	5000	5100	5200	5300	5400	5500	5600	5700
Group 7 & Below	6000	6100	6200	6300	6400	6500	6600	6700
Group 8 & Below	7000	7100	7200	7300	7400	7500	7600	7700
Group 9 & Below	8000	8100	8200	8300	8400	8500	8600	8700
Group 10	Greater than 8000 feet							

TBL A-1 is an air traffic control tool for identifying aircraft, by groups, that are able to land and hold short based on the available landing distance. Air traffic managers shall utilize TBL A-1 for identifying aircraft by groups that are able to land and hold short at their facility in accordance with FAA Order 7110.118, Land and Hold Short Operations.

At locations requesting to utilize LAHSO with aircraft requiring greater than 8,000 feet of available landing distance, air traffic managers shall coordinate with the appropriate Flight Standards' office and Air Traffic Operations, Terminal Safety and Operations Support to obtain a letter of authorization approving LAHSO.

Fixed-Wing Aircraft

ADAM AIRCRAFT (USA)

Model	Type Designator	Description	Performance Information			
			Number & Type Engines/ Weight Class	Climb Rate (fpm)	Descent Rate (fpm)	SRS Cat.
A-500, CarbonAero	A500	2P/S			II	

AERMACCHI SpA (Italy)

(Also AGUSTA, SIAI-MARCHETTI)

Model	Type Designator	Description	Performance Information			
			Number & Type Engines/ Weight Class	Climb Rate (fpm)	Descent Rate (fpm)	SRS Cat.
AMX	AMX*	1J/S+			III	
FN-333 Riviera***	FN33	1P/S			I	
MB-290TP Redigo	L90	1T/S			I	
MB-326	M32	1J/S			III	
MB-339	M339*	1J/S			III	
SF-205-18F/20F	S05F	1P/S			I	
SF-205-18R/20R/22R	S05R	1P/S			I	
S-208	S208	1P/S			I	
S-211	S211	1T/S			I	
SF-260 A/B/C/D/E/F/M/W, Warrior	F260	1P/S			I	
SF-260TP	F26T	1T/S	1,800	1,100	I	3
SF-600A, SF-600TP Canguero	F600	2T/S	2,100		II	4

AERONCA (USA- see Bellanca)

AERO SPACELINES (USA)

Model	Type Designator	Description	Performance Information			
			Number & Type Engines/ Weight Class	Climb Rate (fpm)	Descent Rate (fpm)	SRS Cat.
Super Guppy, Super Turbine Guppy	SGUP	4T/L	1,500	1,500	III	10

AEROSPATIALE (France)

(Also AEROSPATIALE/AERITALIA, ATR, ALENIA MORANE-SAULNIER, PZL-OKECIE, SOCATA, SUD, SUD-EST, TBM)

Model	Type Designator	Description	Performance Information			
			Number & Type Engines/ Weight Class	Climb Rate (fpm)	Descent Rate (fpm)	SRS Cat.
ATR-42-200/300/320	AT43	2T/L	2,000	2,000	III	5
ATR-42-400	AT44	2T/L	2,000	2,000	III	5
ATR-42-500	AT45	2T/L	2,000	2,000	III	5
ATR-72	AT72	2T/L	2,000	2,000	III	6

Model	Type Designator	Description	Performance Information			
			Number & Type Engines/ Weight Class	Climb Rate (fpm)	Descent Rate (fpm)	SRS Cat.
Rallye, Rallye Club, Super Rallye, Rallye Commodore, Minerva (MS-880 to 894)	RALL	1P/S	750	750	I	3
SE-210 Caravelle	S210	2J/L	2,300	2,000	III	8
SN-601 Corvette	S601	2J/S+	2,500	2,000	III	5
Tampico TB-9	TAMP	1P/S	600	700	I	2
TBM TB-700	TBM7	1T/S	1,700	1,500	I	5
Tabago TB10C/200	TOBA	1P/S	700	700	I	2
Trinidad TB-20/21	TRIN	1P/S	850	700	I	3

AIRBUS INDUSTRIES (International)

Model	Type Designator	Description	Performance Information			
			Number & Type Engines/ Weight Class	Climb Rate (fpm)	Descent Rate (fpm)	SRS Cat.
A-300B2/4-1/2/100/200, A-300C4-200	A30B	2J/H	3,500	3,500	III	8
A-300B4 - 600	A306	2J/H	3,500	3,500	III	7
A-310 (CC-150 Polaris)	A310	2J/H	3,500	3,500	III	7
A-318	A318	2J/L	3,500	3,500	III	
A-319, ACJ	A319	2J/L	3,500	3,500	III	7
A-320	A320	2J/L	3,500	3,500	III	7
A-321	A321	2J/L	3,500	3,500	III	
A-300ST Super Transporter, Beluga	A3ST	2J/H			III	
A-330-200	A332	2J/H	3,500	3,500	III	8
A-330-300	A333	2J/H			III	8
A-340-200	A342	4J/H	3,500	3,500	III	9
A-340-300	A343	4J/H			III	9
A-340-500	A345	4J/H			III	9
A-340-600	A346	4J/H			III	9

AIRCRAFT HYDRO-FORMING (USA)

(Also BUSHMASTER)

Model	Type Designator	Description	Performance Information			
			Number & Type Engines/ Weight Class	Climb Rate (fpm)	Descent Rate (fpm)	SRS Cat.
Bushmaster 2000	BU20	3P/S+	2,000	2,000	III	2

AIR TRACTOR, INC. (USA)

Model	Type Designator	Description	Performance Information			
			Number & Type Engines/ Weight Class	Climb Rate (fpm)	Descent Rate (fpm)	SRS Cat.
AT-300/301/401	AT3P	1P/S	1,000		I	1
AT-302/400/402	AT3T	1T/S			I	
AT-501	AT5P	1P/S			I	
AT-502/503	AT5T	1T/S			I	
AT-602	AT6T	1T/S			I	
AT-802	AT8T	1T/S+			III	

ANTONOV (Russia)

Model	Type Designator	Description	Performance Information			
			Number & Type Engines/ Weight Class	Climb Rate (fpm)	Descent Rate (fpm)	SRS Cat.
An-2	AN2	1P/S			I	
An-8	AN8	2T/L			III	
An-12	AN12	4T/L			III	
An-70	AN70	4T/H			III	
An-72/74	AN72	2J/L			III	
An-124 Ruslan	A124	4J/H			III	
An-140	A140	2T/L			III	

AVIATION DEVELOPMENT (USA)

Model	Type Designator	Description	Performance Information			
			Number & Type Engines/ Weight Class	Climb Rate (fpm)	Descent Rate (fpm)	SRS Cat.
Alaskan Bushmaster	ALBU	1P/S			I	

BEAGLE AIRCRAFT (UK)*(Also BEAGLE-AUSTER)*

Model	Type Designator	Description	Performance Information			
			Number & Type Engines/ Weight Class	Climb Rate (fpm)	Descent Rate (fpm)	SRS Cat.
A-109 Airedale	AIRD	1P/S			I	
B-121 Pup	PUP	1P/S	575	750	I	2
B-125 Bulldog	BDOG	1P/S			I	
B-206 Basset	BASS	2P/S	1,200	1,300	II	8

BEECH AIRCRAFT COMPANY (USA)

(Also CCF, COLEMILL, DINFIA, EXCALIBUR, FUJI, HAMILTON, JETCRAFTERS, RAYTHEON, SWEARINGEN, VOLPAR)

Model	Type Designator	Description	Performance Information			
			Number & Type Engines/ Weight Class	Climb Rate (fpm)	Descent Rate (fpm)	SRS Cat.
1900 (C-12J)	B190	2T/S+	2,400	2,400	III	7
B300 Super King Air 350	B350	2T/S+	3,000	3,000	III	7
100 King Air (U-21F Ute)	BE10	2T/S	2,250	2,250	II	7
17 Stagger Wing (UC-43 Traveler, YC-43 Traveler)	BE17	1P/S	1,375	1,375	I	2
Twin Beech 18/Super H18	BE18	2P/S	1,400	1,000	II	4
18 (turbine)	B18T	2T/S	2,000	2,000	II	
19 Musketeer Sport, Sport	BE19	1P/S	680	680	I	1
200, 1300 Super King Air, Commuter (C-12A to F, C-12L/R, UC-12, RC-12, Tp101, Huron)	BE20	2T/S+	2,450	2,500	III	7
23 Musketeer, Sundowner	BE23	1P/S	740	800	I	2
24 Musketeer Super, Sierra	BE24	1P/S	1,000	1,000	I	3
300 Super King Air	BE30	2T/S+	3,000	3,000	III	6
33 Debonair, Bonanza (E-24)	BE33	1P/S	1,000	1,000	I	4
35 Bonanza	BE35	1P/S	1,200	1,200	I	3
36 Bonanza (piston)	BE36	1P/S	1,100	1,100	I	2
36 Bonanza (turbine)	B36T	1T/S			I	
400 Beechjet, Hawker 400 (T-1 Jayhawk, T-400)	BE40	2J/S+	3,300	2,200	III	8
50 Twin Bonanza (U-8D/E/G, RU-8 Seminole)	BE50	2P/S	1,600	1,600	II	4
55 Baron (T-42 Chochise, C-55, E-20)	BE55	2P/S	1,700	1,700	II	6
56 Turbo Baron	BE56	2P/S			II	
58 Baron	BE58	2P/S	1,730	1,730	II	6
60 Duke	BE60	2P/S	1,600	1,600	II	8
65 Queen Air (U-8F Seminole)	BE65	2P/S	1,300	1,300	II	5
70 Queen Air	BE70	2P/S			II	
76 Duchess	BE76	2P/S	1,500	1,500	II	4
77 Skipper	BE77	1P/S	750	750	I	1
80 Queen Air (Zamir)	BE80	2P/S	1,275	1,275	II	
88 Queen Air	BE88	2P/S			II	
95 Travel Air	BE95	2P/S	1,250	1,250	II	5
99 Airliner	BE99	2T/S	1,750	1,750	II	5
90, A90 to E90 King Air (T-44 V-C6)	BE9L	2T/S	2,000	2,000	II	5
F90 King Air	BE9T	2T/S	2,600	2,600	II	7
2000 Starship	STAR	2T/S+	2,650	2,650	III	7
Premier 1, 390	PRM1	2J/S+	3,000	3,000	III	
T34A/B, E-17 Mentor (45)	T34P	1P/S	1,150	1,150	I	1
T-34C Turbo Mentor	T34T	1T/S	1,100	1,000	I	
T-6A Texan II	TEX2*	1T/S			I	
U-21A/G, EU-21, JU-21, RU-21, Ute (A90-1 to 4)	U21	2T/S	2,000	2,000	II	
QU-22 (1074/1079)	U22	1P/S			I	

BELLANCA AIRCRAFT (USA)*(Also AERONCA, CHAMPION, DOWNER, HINDUSTAN, NORTHERN)*

Model	Type Designator	Description	Performance Information			
			Number & Type Engines/ Weight Class	Climb Rate (fpm)	Descent Rate (fpm)	SRS Cat.
Aeronca Chief/Super Chief, Pushpak	AR11	1P/S	500	500	I	1
Aeronca Sedan	AR15	1P/S	500	500	I	2
14 Junior, Cruiseair, Cruiseair Senior Cruiseaster	B14A	1P/S	1,030	1,030	I	1
14 Bellanca 260/A/B/C	B14C	1P/S	1,500		I	
17 Viking, Super Viking, Turbo Viking	BL17	1P/S	1,100	1,100	I	1
19 Skyrocket	BL19	1P/S			I	
8 Decathlon, Scout	BL8	1P/S	1,000	1,000	I	2
Champion Lancer 402	CH40	2P/S	650	1,000	II	
7 ACA/ECA Champ, Citabria,	CH7A	1P/S	750	750	I	1
7 GCBC/KCAB Citabria	CH7B	1P/S	1,100	1,100	I	1
T-250 Aries	T250	1P/S			I	

BOEING COMPANY (USA)*(Also GRUMMAN, IAI, LOCKHEED-BOEING, MCDONNELL DOUGLAS, NORTHROP-GRUMMAN, ROHR)*

Model	Type Designator	Description	Performance Information			
			Number & Type Engines/ Weight Class	Climb Rate (fpm)	Descent Rate (fpm)	SRS Cat.
B-52 Stratofortress	B52	8J/H	3,000	3,000	III	
707-100 (C-137B)	B701	4J/H	3,500	3,500	III	9
707-300(C-18, C-137C, E-8J-Stars, EC-18, EC-137, KC-137, T-17)	B703	4J/H	3,500	3,500	III	9
717-200	B712	2J/L			III	7
720	B720	4J/L	3,000	3,000	III	9
727-100 (C-22)	B721	3J/L	4,500	4,500	III	7
727-200	B722	3J/L	4,500	4,500	III	7
727-100RE Super 27	R721	3J/L	4,300	4,300	III	
727-200RE Super 27	R722	3J/L	4,300	4,300	III	
727 Stage 3 (-100 or -200)	B72Q	3J/L	4,500	4,500	III	
737-100	B731	2J/L	3,000	3,000	III	7
737-200 (Surveiller, CT-43, VC-96)	B732	2J/L	3,000	3,000	III	7
B737 Stage 3	B73Q	2J/L	3,000	3,000	III	
737-300	B733	2J/L	5,500	3,500	III	7
737-400	B734	2J/L	6,500	3,500	III	8
737-500	B735	2J/L	5,500	3,500	III	7
737-600	B736	2J/L	4,000	4,000	III	7
737-700, BBJ, C-40	B737	2J/L	4,000	4,000	III	8
737-800, BBJ2	B738	2J/L	4,000	4,000	III	7
737-900	B739	2J/L	4,000	4,000	III	8
747-100	B741	4J/H	3,000	3,000	III	10
747-200 (E-4, VC-25)	B742	4J/H	3,000	3,000	III	10
747-300	B743	4J/H	3,000	3,000	III	10
747-400 (Domestic, no winglets)	B74D	4J/H	3,000	3,000	III	
747-400 (International, winglets)	B744	4J/H	3,000	3,000	III	10

Model	Type Designator	Description	Performance Information			
			Number & Type Engines/ Weight Class	Climb Rate (fpm)	Descent Rate (fpm)	SRS Cat.
747SR	B74R	4J/H	3,000	3,000	III	10
747SP	B74S	4J/H	3,000	3,000	III	9
757-200 (C-32)	B752	2J/L	3,500	2,500	III	7
757-300	B753	2J/H	3,500	2,500	III	8
767-200	B762	2J/H	3,500	3,500	III	9
767-300	B763	2J/H	3,500	3,500	III	9
767-400	B764	2J/H	3,500	3,500	III	9
777-200	B772	2J/H	2,500	2,500	III	9
777-300	B773	2J/H	2,500	2,500	III	9
747SCA Shuttle Carrier	BSCA	4J/H			III	
C-135B/C/E/K Stratolifter (EC-135, NKC-135, OC-135, TC-135, WC-135)	C135	4J/H	2,000	2,000	III	
C-17 Globemaster 3	C17	4J/H			III	
C-97 Stratofreighter	C97	4P/L	2,500	3,000	III	
KC-135A Stratotanker (J57 engines)	K35A	4J/H	2,500	3,000	III	
KC 135D/E Stratotanker (TF33 engines)	K35E	4J/H	5,000	3,000	III	
KC 135R/T, C-135FR, Stratotanker (CFM56 engines)	K35R	4J/H	5,000	3,000	III	
KE-3	KE3	4J/H	3,500	3,500	III	
RC-135	R135	4J/H	3,000	3,000	III	
E-3A (TF33), E-B/C, JE-3, Sentry	E3TF	4J/H	3,500	4,000	III	
E-3A (CFM56), E-3D/F, Sentry	E3CF	4J/H			III	
E6 Mercury	E6	4J/H	3,500	3,500	III	
E-767	E767	2J/H	2,500	2,500	III	
75 Kaydet (PT-13, PT-17, PT-18, PT-27, N2S)	ST75	1P/S	840	840	I	

BOMBARDIER (Canada)*(Also CANADAIR)*

Model	Type Designator	Description	Performance Information			
			Number & Type Engines/ Weight Class	Climb Rate (fpm)	Descent Rate (fpm)	SRS Cat.
BD-100 Challenger 300	CL30	2J/S+	3,500	3,500	III	
BD-700 Global 5000	GL5T	2J/L	3,500	3,500	III	

BRITISH AEROSPACE (BAe) (UK)*(Also AIL, AVRO, BAC, BUCURESTI, DE HAVILLAND, HANDLEY-PAGE, HAWKER-SIDDELEY, JETSTREAM, KANPUR, MCDONNELL-DOUGLAS, RAYTHEON, SCOTTISH-AVIATION, VOLPAR)*

Model	Type Designator	Description	Performance Information			
			Number & Type Engines/ Weight Class	Climb Rate (fpm)	Descent Rate (fpm)	SRS Cat.
BAe 748 (Andover, C-91)	A748	2T/L	2,500	2,000	III	5
ATP Advance Turboprop (ATP)	ATP	2T/L	3,000	3,000	III	6
BAC-111 One-Eleven	BA11	2J/L	2,400	2,400	III	7
BAC-167 Strikemaster	JPRO	1J/S			III	

Model	Type Designator	Description	Performance Information			
			Number & Type Engines/ Weight Class	Climb Rate (fpm)	Descent Rate (fpm)	SRS Cat.
BAe HS 125 Series 1/2/3/400/600	H25A	2J/S+	2,500	2,000	III	6
BAe-125-700/800 (C-29, U-125)	H25B	2J/S+	3,000	4,000	III	7
BAe-125-1000	H25C	2J/S+	3,000	4,000	III	7
BAe-146-100 Statesman	B461	4J/L	3,500	3,500	III	7
BAe-146-200 Quiet Trader, Statesman	B462	4J/L	3,500	3,500	III	7
BAe-146-300	B463	4J/L			III	7
BAe-3100 Jetstream 31 (T.Mk.3)	JS31	2T/S+	2200	2200	III	5
BAe-3200 Jetstream Super 31	JS32	2T/S+	2600	2600	III	5
BAe-4100 Jetstream 41	JS41	2T/S+	2200		III	7
Harrier, Sea Harrier	HAR*	1J/L	5,000	8,000	III	
Hawk, T-45 Goshawk, CT-155 Hawk	HAWK	1J/S+			III	
Jetstream 1	JS1	2T/S+	2,200	2,200	III	
Jetstream 3	JS3	2T/S+	2,200	2,300	III	
Jetstream 200	JS20	2T/S+	2,200	2,200	III	
Nimrod	N1M	4J/L			III	
RJ-70	RJ70	4J/L			III	
RJ-85	RJ85	4J/L			III	
RJ-100	RJ1H	4J/L			III	
Tornado	TOR	2J/L			III	

BRITTEN NORMAN LTD. (A subsidiary of Pilatus Aircraft LTD.) (UK)

(Also AVIONS FAIREY, BAC, BUCURESTI, DE HAVILLAND, HAWKER-SIDDELEY, IRMA, PADC, ROMAERO, VICKERS)

Model	Type Designator	Description	Performance Information			
			Number & Type Engines/ Weight Class	Climb Rate (fpm)	Descent Rate (fpm)	SRS Cat.
BN-2, BN-2A/B Islander, Defender, Maritime Defender	BN2P	2P/S	1,250	1,250	II	1
BN-2T Turbine Islander, Turbine Defender	BN2T	2T/S	1,500	1,500	II	1
Trident	TRID	3J/L	3,000	3,000	III	
BN-2A Mk3 Trislander	TRIS	3P/S	1,200	1,000	III	2
VC-10	VC10	4J/H	1,900	2,000	III	
Viscount	VISC	4T/L	1,200	1,500	III	10

BUSHMASTER AIRCRAFT CORP. (USA—see Aircraft Hydro Forming)

CAMAIR AIRCRAFT CORP. (USA)

(Also RILEY, TEMCO)

Model	Type Designator	Description	Performance Information			
			Number & Type Engines/ Weight Class	Climb Rate (fpm)	Descent Rate (fpm)	SRS Cat.
480 Twin Navion 480	TNAV	2P/S	1,800	2,000	II	

CANADAIR BOMBARDIER LTD. (Canada)

Model	Type Designator	Description	Performance Information			
			Number & Type Engines/ Weight Class	Climb Rate (fpm)	Descent Rate (fpm)	SRS Cat.
CL-41 Tutor (CT-114)	CL41	1J/S			III	
CL-44 Forty Four	CL44	4T/L			III	
CL-44-O Guppy	CL4G	4T/L			III	
CL-66, CV-580 (CC-109 Cosmopolitan)	CVLT	2T/L	1,500	1,500	III	
CL-600/Challenger 699/601/604 (CC-144, CE-144)	CL60	2J/L	2,250	3,000	III	8
CL-600 Regional Jet CRJ-100, RJ-100	CRJ1	2J/L			III	7
CL-600, Regional Jet CRJ-200, RJ-200	CRJ2	2J/L			III	7
CL-600 Regional Jet CRJ-700	CRJ7	2J/L			III	7
CL-600 Regional Jet CRJ-900	CRJ9	2J/L			III	
T-33, CT-133 Silver Star (CL-30)	T33	1J/L	2,000	2,000	III	

CESSNA AIRCRAFT COMPANY (USA)

(Also AVIONES-COLOMBIA, COLEMILL, DINFIA, ECTOR, FMA, FUJI, REIMS, RILEY, SUMMIT, WREN)

Model	Type Designator	Description	Performance Information			
			Number & Type Engines/ Weight Class	Climb Rate (fpm)	Descent Rate (fpm)	SRS Cat.
A-37 Dragonfly (318D/E), OA-37	A37*	2J/S	3,370	3,000	III	
120	C120	1P/S	640	640	I	1
140	C140	1P/S	640	640	I	3
150, A150, Commuter, Aerobat	C150	1P/S	670	1,000	I	1
152, A152, Aerobat	C152	1P/S	750	1,000	I	1
170	C170	1P/S	690	1,000	I	4
172, P172, R172, Skyhawk, Hawk XP, Cutlass (T-41, Mescalero)	C172	1P/S	650	1,000	I	1
172RG, Cutlass RG	C72R	1P/S	650	1,000	I	1
175, Skylark	C175	1P/S	850	1,000	I	2
177, Cardinal	C177	1P/S	850	1,000	I	2
177, Cardinal RG	C77R	1P/S	850	1,000	I	2
180, Skywagon 180 (U-17C)	C180	1P/S	1,130	1,130	I	2
182, Skylane	C182	1P/S	890	1,000	I	2
R182, TR182 (Turbo) Skylane RG	C82R	1P/S	890	1,000	I	2
185, A185 Skywagon, Skywagon 185, AgCarryall (U-17A/B)	C185	1P/S	1,000	1,000	I	2
188, A188, T188 AgWagon, AgPickup AgTruck, AgHusky	C188	1P/S	1,000	1,000	I	1
190	C190	1P/S	1,090	1,090	I	2
195 (LC-126)	C195	1P/S	1,200	1,200	I	
205	C205	1P/S	965	1,000	I	3
206, P206m T206m TP206, U206, TU206, (Turbo) Super Skywagon, (Turbo) Super Skyland, (Turbo) Skywagon 206, (Turbo) Stationair, Turbo Stationair 6	C206	1P/S	975	1,000	I	2

Model	Type Designator	Description	Performance Information			
			Number & Type Engines/ Weight Class	Climb Rate (fpm)	Descent Rate (fpm)	SRS Cat.
206 (turbine)	C06T	1T/S			I	
207 (Turbo) Skywagon 207, (Turbo) Stationair 7/8	C207	1P/S	810	1,000	I	2
207 (turbine)	C07T	1T/S			I	
208 Caravan 1, (Super) Cargomaster, Grand Caravan (C-98, U27)	C208	1T/S	1,400	1,400	I	3
210, T210, (Turbo) Centurion	C210	1P/S	900	1,000	I	2
P210 Pressurized Centurion	P210	1P/S	1,000	1,000	I	
P210 (turbine)	C07T	1T/S			I	
T303 Crusader	C303	2P/S	3,500	3,000	II	2
310, T310 (U-3, L-27)	C310	2P/S	2,800	2,000	II	4
320 (Executive) Skyknight	C320	2P/S	2,900	2,000	II	5
335	C335	2P/S	2,200	2,000	II	4
336 Skymaster	C336	2P/S	1,340	1,340	II	
337, M337, MC337, T337B/C/D/E/F/H (Turbo) Super Skymaster (O-2)	C337	2P/S	1,250	1,500	II	3
T337G, P337 Pressurized Skymaster	P337	2P/S	1,250	1,500	II	3
340	C340	2P/S	2,900	2,000	II	4
401, 402, Utililiner, Businessliner	C402	2P/S	2,500	2,000	II	3
402 (turbine)	C02T	2T/S			II	
404 Titan	C404	2P/S	2,600	2,000	II	5
404 (turbine)	C04T	2T/S			II	
F406 Caravan 2, Vigilant	F406	2T/S	1,850		II	6
411	C411	2P/S	2,800	2,000	II	4
414, Chancellor 414	C414	2P/S	2,300	2,000	II	6
414 (turbine)	C14T	2T/S			II	
421, Golden Eagle, Executive Commuter	C421	2P/S			II	6
421 (turbine)	C21T	2T/S			II	
425, Corsair, Conquest 1	C425	2T/S	3,500	2,500	II	5
441 Conquest, Conquest 2	C441	2T/S	4,200	3,000	II	6
5000 Citation, Citation 1	C500	2J/S	3,100	3,500	III	6
501 Citation 1SP	C501	2J/S	4,300	3,000	III	6
525 Citationjet Citation CJ1	C525	2J/S	3,000		III	7
525A Citation CJ2	C25A	2J/S	3,870		III	
525B Citation CJ3	C25B	2J/S+			III	
526 Citationjet	C526	2J/S	3,000		III	
550, S550, 552 Citation 2/S2/Bravo (T-47, U-20)	C550	2J/S+	5,300	3,000	III	7
551 Citation 2SP	C551	2J/S	5,300	3,000	III	5
560 Citation 5/5 Ultra/5Ultra Encore (UC-35, OT-47, TR-20)	C560	2J/S+	6,000	3,500	III	8
650 Citation 3/6/7	C650	2J/S+	3,900	4,000	III	8
680 Citation Sovereign	C680	2J/S+			III	
750 Citation 10	C750	2J/S+	3,500	3,500	III	9
AW	CAW	1P/S			I	

Model	Type Designator	Description	Performance Information			
			Number & Type Engines/ Weight Class	Climb Rate (fpm)	Descent Rate (fpm)	SRS Cat.
O-1, TO-1, OE, L-19, TL-19 Bird Dog (305,321)	O1	1P/S	1,150	1,150	I	
T37 (318A/B/C)	T37*	2J/S	3,000	3,000	III	
T-50 Bobcat (AT-8, AT-17, UC-78, Crane)	T50	2P/S			II	
DC-6	CDC6	1P/S			I	
C-34/37/38/145/165, Airmaster	CMAS	1P/S			I	

CHAMPION (USA—see Bellanca Aircraft)**CHRISTEN INDUSTRIES, INC. (USA)***(Also AVIAT)*

Model	Type Designator	Description	Performance Information			
			Number & Type Engines/ Weight Class	Climb Rate (fpm)	Descent Rate (fpm)	SRS Cat.
A-1 Huskey	HUSK	1P/S	1,500	1,500	I	

COLEMILL (USA) (See BEECH, PIPER, CESSNA)**CONSTRUCCIONES AERONAUTICAS (CASA) (Spain)***(Also NURTANIO, NUSANTARA)*

Model	Type Designator	Description	Performance Information			
			Number & Type Engines/ Weight Class	Climb Rate (fpm)	Descent Rate (fpm)	SRS Cat.
C-212 Aviocar (T-12, TE-12, TR-12, D-3, Tp89)	C212	2T/S+	900	900	III	5

CURTISS-WRIGHT CORP. (USA)

Model	Type Designator	Description	Performance Information			
			Number & Type Engines/ Weight Class	Climb Rate (fpm)	Descent Rate (fpm)	SRS Cat.
C-46 Commando (CW-20)	C46	2P/L	600	700	III	

DASSAULT-BREGUET (France)

Model	Type Designator	Description	Performance Information			
			Number & Type Engines/ Weight Class	Climb Rate (fpm)	Descent Rate (fpm)	SRS Cat.
1150 Atlantic, Altantique 2	ATLA	2T/L			III	
Alpha Jet	AJET	2J/S			III	
Falcon 10/100, Mystere 10/100	FA10	2J/S+	2,300	1,600	III	8
Falcon 20/100, Mystere 20/200, Gardian (HU-25, (T-11, TM-11)	FA20	2J/S+	2,000	2,200	III	7
Falcon 50, Mystere 50 (T-16)	FA50	3J/S+	1,800	1,600	III	8
Falcon 900, Mystere 900 (T-18)	F900	3J/L	2,000	1,700	III	8
Falcon 2000	F2TH	2J/S+	2,500	1,500	III	8
Jaguar	JAGR	2J/S+			III	
Mirage 2000, Vajara	MIR2	1J/S+			III	
Mirage 3/5/50 (F-103)	MIRA	1J/S+			III	
Mirage F1 (C-14, CE-14)	MRF1	1J/S+			III	
Super Etendard	ETAR	1J/S+			III	

DEHAVILLAND (Canada/UK)*(Also AIRTECH, HAWKER-SIDDELEY, OGMA, RILEY, SCENIC)*

Model	Type Designator	Description	Performance Information			
			Number & Type Engines/ Weight Class	Climb Rate (fpm)	Descent Rate (fpm)	SRS Cat.
DH-106 Comet	COMT	4J/L	2,900	2,000	III	9
DHC-1	DHC1	1P/S	900	1,000	I	1
DHC-2 Mk1 Beaver (U-6, L-20)	DHC2	1P/S	840	1,000	I	2
DHC-2 Mk3 Turbo Beaver	DH2T	1T/S	1,220	1,000	I	2
DHC-3 Otter (U-1, NU-1, UC)	DHC3	1P/S	750	1,000	I	1
DHC-3 Turbo Otter	DH3T	1T/S			I	
DHC-4 Caribou (C-7, CV-2)	DHC4	2P/S+	1,350	1,000	III	5
DHC-5 (C-8, CV-7, CC-115, C-115)	DHC5	2T/L	2,000	1,500	III	1
DHC-6 Twin Otter (UV-18, CC-138)	DHC6	2T/S	1,600	1,800	II	4
DHC-7 Dash 7 (O-5, EO-5)	DHC7	4T/L	4,000	4,000	III	2
DHC8 - 100 Dash 8 (E-9, CT-142, CC-142)	DH8A	2T/L	1,500	1,500	III	4
DHC8 - 200 Dash 8	DH8B	2T/L	1,500	1,500	III	4
DHC8 - 300 Dash 8	DH8C	2T/L	1,500	1,500	III	5
DHC8 - 400 Dash 8	DH8D	2T/L	2,500	2,500	III	
DH-104 Dove, Sea Devon	DOVE	2P/S	1,420	1,420	II	4
DH-114 Heron	HERN	4P/S+	1,075	1,075	III	8

DIAMOND (Canada)*(Also HOAC)*

Model	Type Designator	Description	Performance Information			
			Number & Type Engines/ Weight Class	Climb Rate (fpm)	Descent Rate (fpm)	SRS Cat.
DA-20/22, DV-20 Katana, Speed Katana	DV20	1P/S	730	-	I	
DA-42 TwinStar	DA42	2P/S	1,500	1,500	II	

DORNIER GmbH (FRG)*(Also CASA, HINDUSTAN. Also see FAIRCHILD-DORNIER)*

Model	Type Designator	Description	Performance Information			
			Number & Type Engines/ Weight Class	Climb Rate (fpm)	Descent Rate (fpm)	SRS Cat.
228	D228	2T/S+	2,000	2,000	III	2
328	D328	2T/S+	2,000	2,000	III	7
27	DO27	1P/S	700	800	I	1
Do 28 A/B (Agur)	DO28	2P/S	1,500	1,500	II	
Do 28D/D-1/D-2, 128-2 Skyservant	D28D	2P/S	1,000	–	II	1
Do-28D-6, 128-6 Turbo Skyservant	D28T	2T/S	1,500	–	II	1

EMBRAER (Brazil)

Model	Type Designator	Description	Performance Information			
			Number & Type Engines/ Weight Class	Climb Rate (fpm)	Descent Rate (fpm)	SRS Cat.
CBA-123 Vector	VECT	2T/S+			III	
EMB-110/111 Bandeirante (C-95, EC-95, P-95, R-95, SC-95)	E110	2T/S+	1,500	1,500	III	7
EMB-120 Brasilia (VC-97)	E120	2T/S+	2,300	2,300	III	7
EMB-121 Xingu (VU-9, EC-9)	E121	2T/S+			III	
EMB-135, ERJ-135/140	E135	2J/L	2,410	2,030	III	7
EMB-145, ERJ-145 (R-99)	E145	2J/L	2,350	2,190	III	7
EMB-145XR	E45X	2J/L			III	7
EMB-170/175	E170	2J/L			III	
EMB-190/195	E190	2J/L			III	

EXTRA (FRG)

Model	Type Designator	Description	Performance Information			
			Number & Type Engines/ Weight Class	Climb Rate (fpm)	Descent Rate (fpm)	SRS Cat.
200	E200	1P/S	1,000	1,000	I	
230	E230	1P/S	1,500	1,500	I	
300, 350	E300	1P/S	2,500	1,500	I	
400	E400	1P/S	1,500	1,500	I	
500	E500	1T/S	1,800	1,800	I	

FAIRCHILD DORNIER (USA/FRG)*(Also CONAIR, FAIRCHILD-HILLER, FLEET, FOKKER, KAISER, PILATUS, SWEARINGEN)*

Model	Type Designator	Description	Performance Information			
			Number & Type Engines/ Weight Class	Climb Rate (fpm)	Descent Rate (fpm)	SRS Cat.
228	D228	2T/S+	2,000	2,000	III	
328	D328	2T/S+	2,000	2,000	III	
328JET, Envoy 3	J328	2J/S+			III	6
728JET, Envoy 7	J728	2J/L			III	

FAIRCHILD INDUSTRIES (USA)*(Also CONAIR, FAIRCHILD-HILLER, FLEET, FOKKER, KAISER, PILATUS, SWEARINGEN)*

Model	Type Designator	Description	Performance Information			
			Number & Type Engines/ Weight Class	Climb Rate (fpm)	Descent Rate (fpm)	SRS Cat.
A-10, OA-10 Thunderbolt 2	A10*	2J/L	6,000	5,000	III	
C-119, R4Q Flying Box Car (F-78)	C119	2P/L	750	750	III	5
C-123 Provider	C123	2P/L	890	1,000	III	
F-27, FH-227	F27	2T/L	3,000	3,000	III	5
M-62 (PT-19/23/26, T-19 Cornell)	FA62	1P/S	650	650	I	
Pilatus/Peacemaker/Porter	PC6P	1P/S	580	600	I	
PC-6 Heli-Porter	PC6T	1T/S	580	600	I	
Merlin 2	SW2	2T/S	2,350	2,500	II	6
SA-226TB, SA-227TT Merlin 3, Fairchild 300	SW3	2T/S+	2,350	2,500	III	5
SA-226AC, SA-227AC/AT Metro, Merlin 4, Expediter	SW4	2T/S+	2,400	2,500	III	5

FOKKER BV (Netherlands)*(Also FAIRCHILD, FAIRCHILD-HILLER)*

Model	Type Designator	Description	Performance Information			
			Number & Type Engines/ Weight Class	Climb Rate (fpm)	Descent Rate (fpm)	SRS Cat.
F-27 Friendship, Troopship, Maritime (C-31, D-2)	F27	2T/L	3,000	3,000	III	
F-28, Fellowship	F28	2J/L	4,650	2,000	III	7
50, Maritime Enforcer	F50	2T/L	3,500	3,500	III	3
60	F60	2T/L	3,500	3,500	III	
70	F70	2J/L	4,500	3,000	III	
100	F100	2J/L	3,500	3,500	III	7

GAF (Australia)

Model	Type Designator	Description	Performance Information			
			Number & Type Engines/ Weight Class	Climb Rate (fpm)	Descent Rate (fpm)	SRS Cat.
N2/22/24 Nomad, Floatmaster, Missionmaster, Searchmaster	NOMA	2T/S	1,300	1,100	II	2

GATES LEARJET CORP. (USA)*(Also LEARJET, LEARJET, SHIN MEIWA)*

Model	Type Designator	Description	Performance Information			
			Number & Type Engines/ Weight Class	Climb Rate (fpm)	Descent Rate (fpm)	SRS Cat.
23	LJ23	2J/S	4,500	4,000	III	8
24	LJ24	2J/S+	4,500	4,000	III	7
25	LJ25	2J/S+	4,500	4,000	III	9
28, 29	LJ28	2J/S+	4,500	4,000	III	7
31	LJ31	2J/S+	4,500	4,000	III	7
35, 36 (C-21, RC-35, RC-36, U-36)	LJ35	2J/S+	4,500	4,000	III	9
40	LJ40	2J/S+			III	

Model	Type Designator	Description	Performance Information			
			Number & Type Engines/ Weight Class	Climb Rate (fpm)	Descent Rate (fpm)	SRS Cat.
45	LJ45	2J/S+			III	
55	LJ55	2J/S+	5,000	4,000	III	8
60	LJ60	2J/S+	5,000	4,000	III	10

GENERAL DYNAMICS CORP. (USA)

(Also BOEING CANADA, CANADAIR, CANADIAN VICKERS, CONSOLIDATED, CONVAIR, FOKKER, GRUMMAN, KELOWNA, LOCKHEED, LOCKHEED MARTIN, MITSUBISHI, SABCA, SAMSUNG, TUSAS)

Model	Type Designator	Description	Performance Information			
			Number & Type Engines/ Weight Class	Climb Rate (fpm)	Descent Rate (fpm)	SRS Cat.
Canso/Catalina***	CAT	2P/S+	600	600	III	7
Convair 990	CV99	4J/L	2,500	2,500	III	10
Convair 240/340/440, Liner, HC-131	CVLP	2P/L	1,000	800	III	7
Convair 540/580/600/640	CVLT	2T/L	1,500	1,500	III	7
F-111, EF-111, (RF-111 Aardvark, Raven)	F111*	2J/L	5,000	5,000	III	
F-16 A/B/C/D/N, NF-16, TF-16 Fighting Falcon, Netz, Barak, Brakeet	F16*	1J/L	8,000	5,000	III	
F-16XL Fighting Falcon	F16X*	1J/L			III	
Valiant	VALI	1P/S	600	750	I	

GREAT LAKES (USA)

Model	Type Designator	Description	Performance Information			
			Number & Type Engines/ Weight Class	Climb Rate (fpm)	Descent Rate (fpm)	SRS Cat.
2T-1 Sport Trainer, Sport	G2T1	1P/S	1,000	800	I	

GROB (FRG)

Model	Type Designator	Description	Performance Information			
			Number & Type Engines/ Weight Class	Climb Rate (fpm)	Descent Rate (fpm)	SRS Cat.
G109 Ranger (Vigilant)	G109	1P/S	600	600	I	2
G115 A/B/C/D/E, Bavarian (Heron), Tutoa	G115	1P/S	1,200	1,100	I	
G-120	G120	1P/S	1,280		I	

GRUMMAN AEROSPACE CORP. (USA)

(Also AERO MOD, AMERICAN GENERAL, GRUMMAN AMERICAN, GULFSTREAM AMERICAN MID-CONTINENT, NORTHROP GRUMMAN, SERV-AERO)

Model	Type Designator	Description	Performance Information			
			Number & Type Engines/ Weight Class	Climb Rate (fpm)	Descent Rate (fpm)	SRS Cat.
A-6, EA-6, KA-6 Intruder, Prowler (G-128)	A6*	2J/L	7,500	5,000	III	
AA1 Trainer, Tr2, T-Cat, Lynx	AA1	1P/S	850	1,250	I	1
AA-5, Traveller, Cheetah Tiger	AA5	1P/S	660	1,000	I	1

Model	Type Designator	Description	Performance Information			
			Number & Type Engines/ Weight Class	Climb Rate (fpm)	Descent Rate (fpm)	SRS Cat.
C-1, TF Trader (G-96)	G96	2P/S+			III	
C-2 Greyhound	C2	2T/L	1,000	2,200	III	
E-2, TE-2, Hawkeye, Daya	E2	2T/L	2,690	3,000	III	
F-3F (G-11/32), Replica	F3F	1P/S			I	
F-6F Hellcat (G-50)	HCA7	1P/S+			III	
F-7F Tigercat (G-51)	TCAT	2P/S+			III	
F-9F Panther (G-79)	F9F	1JS+			III	
F-14 Tomcat	F14*	2J/L	6,000	4,000	III	
G-164 Ag-Cat, Super Ag-Cat	G164	1P/S	1,500	1,500	I	1
G164 Turbo Ag-Cat	G64T	1T/S	1,500	1,500	I	1
G-21 A/38/39 Goose (JRF)***	G21	2P/S	1,000	1,000	III	
G-44 Widgeon (J4F)***	G44	2P/S	1,000	1,500	III	5
G-73 Mallard***	G73	2P/S+	1,600	1,600	III	6
G-73T Turbo Mallard***	G73T	2T/S+			III	
G-1159, G-1159B Gulfstream 2/2B/2SP (C-20J, VC-111)	GLF2	2J/L	5,000	4,000	III	8
GA-7 Cougar	GA7	2P/S	1,600	1,500	II	1
HU-16, SA-16, UF Albatross (G-64/111)***	U16	2P/S+	1,500	1,500	III	4
OV-1, RV-1, AO-1 Mohawk (G-134)	V1	2T/S+	2,100	1,300	III	
S-2, S2F, P-16 Tracker (G-89)	S2P	2P/S+			III	
S-2 Turbo Tracker	S2T	2T/S+			III	
X-29 (712)	X29	1J/S+			III	

GULFSTREAM AEROSPACE CORP. (USA)

(Also GRUMMAN, GRUMMAN AMERICAN, GULFSTREAM, GULFSTREAM AMERICAN, IA1)

Model	Type Designator	Description	Performance Information			
			Number & Type Engines/ Weight Class	Climb Rate (fpm)	Descent Rate (fpm)	SRS Cat.
690 Jetprop Commander 840/900	AC90	2T/S	2,500	2,500	II	
695 Jetprop Commander 980/1000	AC95	2T/S	2,500	2,500	II	
AA-1 T-Cat, Lynx	AA1	1P/S	850	1,250	I	
AA-5 Traveler, Cheetah, Tiger	AA5	1P/S	660	1,000	I	
GA-7 Cougar	GA7	2P/S	1,600	1,500	II	
GAC 159-C, Gulfstream 1	G159	2T/S+	2,000	2,000	III	7
G-1159, G-1159B/TT Gulfstream 2/2B/2SP/2TT	GLF2	2J/L	5,000	4,000	III	
G-1159A Gulfstream 3/SRA-1, SMA-3 (C20A/B/C/D/E)	GLF3	2J/L	5,000	4,000	III	8
G-1159C Gulfstream 300/4/4SP/ 400/SRA-4 (C-20F/G/H, S102, Tp102, U-4)	GLF4	2J/L	5,000	4,000	III	8
G-1159D Gulfstream 5/500/550 (C-37)	GLF5	2J/L	5,000	4,000	III	7

HAMILTON AVIATION (USA)*(Also VOLPAR)*

Model	Type Designator	Description	Performance Information			
			Number & Type Engines/ Weight Class	Climb Rate (fpm)	Descent Rate (fpm)	SRS Cat.
Westwind 2/3	B18T	2T/S	2,000	2,000	II	1
Little Liner	BE18	2P/S	1,400	1,000	II	
T-28 Nomair	T28	1P/S	2,500	2,500	I	

HANDLEY PAGE (UK)*(Also BRITISH AEROSPACE, JETSTREAM, SCOTTISH AVIATION, VOLPAR)*

Model	Type Designator	Description	Performance Information			
			Number & Type Engines/ Weight Class	Climb Rate (fpm)	Descent Rate (fpm)	SRS Cat.
HP-137 Jetstream 1	JS1	2T/S+	2,200	2,200	III	
HP-137 Jetstream 200 (T.Mk1/2)	JS20	2T/S+	2,200	2,200	III	

HELIO AIRCRAFT COMPANY (USA)

Model	Type Designator	Description	Performance Information			
			Number & Type Engines/ Weight Class	Climb Rate (fpm)	Descent Rate (fpm)	SRS Cat.
H-391/392/395/250/295/700/800, HT-295 Courier, Strato-Courier, Super Courier (U-10)	COUR	1P/S	850	1,000	I	1
HST-550 Stallion (AU-24)	STLN	1T/S	2,200	2,200	I	1
H-500 Twin Courier (U-5)	TCOU	2P/S	1,250	1,500	II	1

HFB (FRG)*(Also MBB)*

Model	Type Designator	Description	Performance Information			
			Number & Type Engines/ Weight Class	Climb Rate (fpm)	Descent Rate (fpm)	SRS Cat.
HFB-320 Hansa	HF20	2J/S+	4,500	4,500	III	7

HOWARD (USA)

Model	Type Designator	Description	Performance Information			
			Number & Type Engines/ Weight Class	Climb Rate (fpm)	Descent Rate (fpm)	SRS Cat.
250, 350	L18	2P/L	1,800	2,000	III	8
DGA-15 (GH Nightingale, NH)	DG15	1P/S	1,000	1,000	I	

IAI (Israel)*(Also ISRAEL AIRCRAFT INDUSTRIES, ASTRA, GULFSTREAM)*

Model	Type Designator	Description	Performance Information				
			Number & Type Engines/ Weight Class	Climb Rate (fpm)	Descent Rate (fpm)	SRS Cat.	LAHSO Group
101 Avara, 102, 201, 202	ARVA	2T/S+		1,300	1,000	III	5
1123 Westwind	WW23	2J/S+		4,000	3,500	III	7
1124 Westwind	WW24	2J/S+		4,000	3,500	III	7
1125 Gulfstream 100, (C-38)	ASTR	2J/S+		4,000	3,500	III	7
1126 Gulfstream 200	GALX	2J/S+				III	
Gulfstream 150	G150	2J/S+				III	

ILYUSHIN (Russia)

Model	Type Designator	Description	Performance Information				
			Number & Type Engines/ Weight Class	Climb Rate (fpm)	Descent Rate (fpm)	SRS Cat.	LAHSO Group
A-50, Be-976	A50	4J/H				III	
Il-14	IL14	2P/S+				III	
Il-18/20/22/24, Bizon, Zebra	IL18	4T/L				III	
Il-28	IL28	2J/L				III	
Il-38	IL38	4J/L				III	
IL-62	IL62	4J/H		3,500	2,500	III	
IL-76/78/82, Gajaraj	IL76	4J/H		3,000	2,500	III	
Il-86/87	IL86	4J/H				III	
Il-96	IL96	4J/H				III	
Il-103	I103	1P/S				I	
Il-114	I114	2T/L				III	

JETSTREAM (UK – see British Aerospace)**LAKE AIRCRAFT (USA)**

Model	Type Designator	Description	Performance Information				
			Number & Type Engines/ Weight Class	Climb Rate (fpm)	Descent Rate (fpm)	SRS Cat.	LAHSO Group
LA-250/270 (Turbo) Renegade, Seawolf, SeaFury***	LA25	1P/S		700	700	I	2
LA-4/200, Buccaneer***	LA4	1P/S		1,100	1,000	I	2

LOCKHEED CORP. (USA)*(Also AERITALIA, CANADAI, FIAT, FOKKER, HOWARD, LEAR, LOCKHEED-BOEING, LOCKHEED-MARTIN, MBB, MES-SERSCHMITT, MITSUBISHI, PACAERO, ROCKWELL, SABCA)*

Model	Type Designator	Description	Performance Information				
			Number & Type Engines/ Weight Class	Climb Rate (fpm)	Descent Rate (fpm)	SRS Cat.	LAHSO Group
B-34, PV Venture, Harpoon (L-15/137/237)	L37	2P/S+				III	
C-5 Galaxy (L-500)	C5	4J/H		2,500	2,000	III	

Model	Type Designator	Description	Performance Information			
			Number & Type Engines/ Weight Class	Climb Rate (fpm)	Descent Rate (fpm)	SRS Cat.
C-130A/B/E/F/H, CC-130, DC-130, EC-130/E/G/H/Q, HC-130, JC-130, KC-130B/F/H/R/T, LC-130, MC-130, NC-130, RC-130, TC-130, VC-130, WC-130E/H, T-10, TK-10, TL-10, Tp84 Hercules, Spectre, Aya, Karnaf, Sapeer (L-100/182/282/382)	C130	4T/L	1,500	1,500	III	
C-141 Starlifter (L-300)	C141	4J/H	3,500	3,000	III	
L-049/749/1049 Constellation, Super Constellation, Starliner (C-121, RC-121, EC-121, VC-121, WV, R7V, Warning Star)	CONI	4P/L	1,700	1,700	III	9
F-22 Raptor (L-645)	F22*	2J/L			III	
F-104, RF-104, TF-104 Starfighter (L583/683)	F104*	1J/L	5,000	4,000	III	
F-117 Nighthawk	F117	2J/L			III	
L-1011 Tri-Star (all series)	L101	3J/H	3,500	3,000	III	9
L-18 Lodestar (C-56/57/59/60, R50, XR50)	L18	2P/L	1,800	2,000	III	
L-188 Electra	L188	4T/L	1,850	2,000	III	7
L-1329 Jetstar 6/8	L29A	4J/L	4,000	3,500	III	8
L-1329-5 Jetstar 2/731	L29B	4J/L	4,000	3,000	III	9
P-2D to H, SP-2, P2V Neptune (L-426/726/826)	P2	2P/L			III	
P-3, AP-3, EP-3, NP-3, RP-3, TP-3, UP-3, VP-3, WP-3, CP-140 Orion, Aurora, Arcturus (L-85/285/685/785)	P3	4T/L	1,850	2,000	III	
P-38, F-5 Lightning (L-222/322/422)	P38	2P/S+			III	
S-3, ES-3, US-3 Viking (L-394)	S3	2J/L	2,000	2,000	III	
SR-71 Blackbird	SR71	2J/L			III	
T-33, AT-33, NT-33, RT-33 Shooting Star, T-Bird (L-580)	T33*	2J/L	2,000	2,000	III	
U-2, ER-2	U2*	1J/S+	6,000	6,000	III	

MARTIN COMPANY (USA)

Model	Type Designator	Description	Performance Information			
			Number & Type Engines/ Weight Class	Climb Rate (fpm)	Descent Rate (fpm)	SRS Cat.
404	M404	2P/L	1,600	1,500	III	3
B-26 Marauder (179)	B26M	2P/S+			III	
WB-57 (272)	WB57	2J/L			III	

MAULE AIRCRAFT CORP. (USA)*(Also SAASA)*

Model	Type Designator	Description	Performance Information			
			Number & Type Engines/ Weight Class	Climb Rate (fpm)	Descent Rate (fpm)	SRS Cat.
M-4 Bee Dee, Jetasen, Rocket, Astro Rocket, Strata Rocket	M4	1P/S	1,000	1,000	I	1
M-5, Strata Rocket, Lunar Rocket, Patroller	M5	1P/S	1,000	1,000	I	1
M-6 Super-Rocket	M6	1P/S	1,500	1,000	I	1
M-7-235/260, MT-7-235/260, MX-7-160/180/235, MXT-7-160/180 Super Rocket, Star Rocket, Comet, Star Craft, Orion, Sportplane	M7	1P/S	825		I	1
M-7-420, MT-7-240, MX-7-420, MXT-7-420 Star Craft	M7T	1T/S	4,500		I	1
M-8	M8	1P/S			I	

MCDONNELL-DOUGLAS CORP. (USA)*(Also ASTA, BOEING, DOUGLAS, GAF, LISUNOV, MITSUBISHI, ON MARK, SHANGHAI, VALMET)*

Model	Type Designator	Description	Performance Information			
			Number & Type Engines/ Weight Class	Climb Rate (fpm)	Descent Rate (fpm)	SRS Cat.
Skywarrior	A3*	2J/L	5,000	6,000	III	
A-4, OA-4, TA-4 Skyhawk	A4*	1J/S+	5,000	5,000	III	
Invader	B26	2P/L	1,000	1,000	III	
YC-15	C15	4J/L			III	
C-17 Globemaster 3	C17	4J/H			III	
DC-10 (KC-10 Extender, KDC-10, MD-10)	DC10	3J/H	2,400	2,000	III	9
Skytrain (C-47, C-53, C-117 A/B/C, R4D 1 to 7)	DC3	2P/S+	1,200	1,200	III	
Super DC-3 (C-117D, R4D 8)	DC3S	2P/S+	1,330	1,330	III	8
Skymaster	DC4	4P/L	2,300	2,300	III	7
DC-6/B Liftmaster	DC6	4P/L	1,000	1,000	III	7
DC-7/B/C Seven Seas	DC7	4P/L	1,250	1,250	III	8
DC-8-50, Jet Trader	DC85	4J/H	4,000	4,000	III	9
DC-8-60	DC86	4J/H	4,000	4,000	III	
DC-8-70	DC87	4J/H	5,000	4,000	III	9
DC-8 Stage 3 (US Only)	DC8Q	4J/H	4,000	4,000	III	
DC-9 Stage 3 (US Only)	DC9Q	2J/L	3,000	3,000	III	
DC-9-10	DC91	2J/L	3,000	3,000	III	8
DC-9-20	DC92	2J/L	3,000	3,000	III	8
DC-9-30 (C-9, VC-9, Nightingale, Skytrain 2)	DC93	2J/L	3,000	3,000	III	8
DC-9-40	DC94	2J/L	3,000	3,000	III	8
DC-9-50	DC95	2J/L	3,000	3,000	III	8
F-15 Eagle, Baz, Akef, Ra'am	F15*	2J/L	8,000	5,000	III	
FA-18, CF-18, CF-188, EF-18, C-15, CE-15, AF-18, ATF-18 Hornet, Super Hornet	F18*	2J/L	8,000	6,000	III	
F-4, RF-4, QF-4 Phantom 2/2000, Kurnass	F4*	2J/L	8,000	6,000	III	

Model	Type Designator	Description	Performance Information			
			Number & Type Engines/ Weight Class	Climb Rate (fpm)	Descent Rate (fpm)	SRS Cat.
MD-11	MD11	3J/H			III	9
MD-81	MD81	2J/L	3,500	3,000	III	7
MD-82	MD82	2J/L	3,500	3,000	III	7
MD-83	MD83	2J/L	3,500	3,000	III	8
MD-87	MD87	2J/L	3,500	3,000	III	7
MD-88	MD88	2J/L	3,500	3,000	III	8
MD-90	MD90	2J/L			III	8

MESSERSCHMITT (FRG)

Model	Type Designator	Description	Performance Information			
			Number & Type Engines/ Weight Class	Climb Rate (fpm)	Descent Rate (fpm)	SRS Cat.
Bf-108 Taifun	ME08	1P/S	400	500	I	1
Bf-109	ME09	1P/S			I	
Me-262, Replica	ME62	2J/S+			III	

MESSERSCHMITT-BOLKOW (FRG)*(Also BOLKOW, HFB, NORD, SIAT)*

Model	Type Designator	Description	Performance Information			
			Number & Type Engines/ Weight Class	Climb Rate (fpm)	Descent Rate (fpm)	SRS Cat.
223 Flamingo	S223	1P/S			I	
BO-209 Monsun	B209	1P/S	1,100	1,100	I	4

MITSUBISHI AIRCRAFT INTERNATIONAL INC. (USA/Japan)*(Also BEECH, RAYTHEON)*

Model	Type Designator	Description	Performance Information			
			Number & Type Engines/ Weight Class	Climb Rate (fpm)	Descent Rate (fpm)	SRS Cat.
A6M Zero	ZERO	1P/S			I	
F-1	F1	2J/S+			III	
F-2	F2	1J/L	8,000	5,000	III	
F-86 Sabre	F86	1J/L	4,000	4,000	III	
MU-2, Marquise, Solitaire (LR-1)	MU2	2T/S	3,500	3,000	II	6
MU-300 Diamond	MU30	2J/S+	3,500	4,000	III	7
T-2	MT2	2J/S+			III	

MOONEY AIRCRAFT CORP. (USA)*(Also AEROSTAR, ALON)*

Model	Type Designator	Description	Performance Information			
			Number & Type Engines/ Weight Class	Climb Rate (fpm)	Descent Rate (fpm)	SRS Cat.
A-2 Aircoupe	ERCO	1P/S	630	630	I	2
M-10 Cadet	M10	1P/S	800	800	I	1
M-18 Mite, Wee Scotsman	MITE	1P/S	750	750	I	1
M-20, M-20/A/B/C/D/E/F/G/J/L/R/S, Mark 21, Allegro, Eagle, Ranger, Master, Super 21, Chaparral, Executive, Statesman, Ovation, 201, 202, 205, 220, ATS, MSE, PFM (nonturbocharged engine)	M20P	1P/S	1,000	1,000	I	4
M-20K/M, Encore, Bravo, 231, 252, TLS, TSE (turbocharged engine)	M20T	1P/S	1,500	1,200	I	6
M-22, Mustang	M22	1P/S	1,300	1,300	I	3

MUDRY (France)

Model	Type Designator	Description	Performance Information			
			Number & Type Engines/ Weight Class	Climb Rate (fpm)	Descent Rate (fpm)	SRS Cat.
CAP-10	CP10	1P/S	1,500	2,000	I	4
CAP-20	CP20	1P/S	1,500	2,000	I	4
CAP-21	CP21	1P/S			I	
CAP-230/231/232	CP23	1P/S			I	
D-140 Mousquetaire	D140	1P/S			I	

NAMC (Japan)*(Also MITSUBISHI)*

Model	Type Designator	Description	Performance Information			
			Number & Type Engines/ Weight Class	Climb Rate (fpm)	Descent Rate (fpm)	SRS Cat.
YS-11	YS11	2T/L	1,500	1,500	III	6

NAVION (USA)*(Also CAMAIR, RILEY, TEMCO)*

Model	Type Designator	Description	Performance Information			
			Number & Type Engines/ Weight Class	Climb Rate (fpm)	Descent Rate (fpm)	SRS Cat.
Rangemaster	RANG	1P/S	1,250	1,500	I	1

NOORDYUN AVIATION LTD. (Canada)*(Also CCF)*

Model	Type Designator	Description	Performance Information			
			Number & Type Engines/ Weight Class	Climb Rate (fpm)	Descent Rate (fpm)	SRS Cat.
Norseman Mk 4/5/6	NORS	1P/S	700	1,000	I	2

NORD (France)*(Also AEROSPATIALE, HOLSTE, NORDFLUG, TRANSALL)*

Model	Type Designator	Description	Performance Information			
			Number & Type Engines/ Weight Class	Climb Rate (fpm)	Descent Rate (fpm)	SRS Cat.
Transall C-160	C160	2T/L	2,000	2,000	III	
260 Super Broussard	N260	2T/S+	2,500	2,000	III	
262, Frégate, Mohawk 298	N262	2T/S+	2,500	2,000	III	
1000, 1001, 1002 Pingouin	ME08	1P/S	400	500	III	
1101, 1102, Noralpha, Ramier	N110	1P/S			I	
1200 to 1204 Norecrin	N120	1P/S			I	
2501 to 2508 Noratlas	NORA	2P/L	1,500	1,500	III	
3202	N320	1P/S			I	
3400	N340	1P/S			I	
SV-4	SV4	1P/S			I	

NORTHERN AVIATION (USA—see Bellanca)**NORTHROP CORP. (USA)***(Also CANADAIR, CASA, AIDC, F+W EMMEN, KOREAN AIR, NORTHROP GRUMMAN)*

Model	Type Designator	Description	Performance Information			
			Number & Type Engines/ Weight Class	Climb Rate (fpm)	Descent Rate (fpm)	SRS Cat.
B-2 Spirit	B2	4J/H			III	
C-125 Raider	C125	3P/L			III	
E-2 Hawkeye	E2	2T/L	2,690	3,000	III	
F-5, RF-5 Freedom Fighter, Tiger 2, Tigereye (N-156C/F)	F5*	2J/S+	8,000	5,000	III	
P-61 Black Widow	P61	2P/S+			III	
T-38, AT-38 Talon (N-156T)	T38*	2J/S+	8,000	5,000	III	

PARTENAVIA (Italy)

Model	Type Designator	Description	Performance Information			
			Number & Type Engines/ Weight Class	Climb Rate (fpm)	Descent Rate (fpm)	SRS Cat.
AP-68TP-300 Spartacus	P68T	2T/S	1,500	1,500	II	3
AP-68TP-600 Viator	VTOR	2T/S	1,500	1,500	II	8
P-57 Fachiro 2	P57	1P/S			I	
P-64/66 Oscar, Charlie	OSCR	1P/S	800	1,000	I	2
P68, Victor, Observer	P68	2P/S	1,200	1,000	I	3

PIAGGIO (Industrie Aeronautiche E Meccaniche Rinaldo Piaggio SpA) (Italy)*(Also PIAGGIO-DOUGLAS, TRECKER)*

Model	Type Designator	Description	Performance Information			
			Number & Type Engines/ Weight Class	Climb Rate (fpm)	Descent Rate (fpm)	SRS Cat.
P-136***	P136	2P/S	1,250	1,500	II	4
P-148	P148	1P/S			I	
P-149	P149	1P/S			I	
P-166, P-166A/B/C/DL2/M/S, Portofino, Albatross	P66P	2P/S	1,350	1,500	II	3
P-166DL3/DP1	P66T	2T/S			II	
P-180 Avanti	P180	2T/S			II	1
PD-808	P808	2J/S+	4,000	3,500	III	9

PILATUS FLUGZEUGWERKE AG (Switzerland)*(Also FAIRCHILD, FAIRCHILD-HILLER)*

Model	Type Designator	Description	Performance Information			
			Number & Type Engines/ Weight Class	Climb Rate (fpm)	Descent Rate (fpm)	SRS Cat.
P-2	PP2	1P/S			I	
P-3	PP3	1P/S			I	
PC-6 Porter	PC6P	1P/S	600	600	I	
PC-6A/B/C Turbo Porter (UV-20 Chiricahua)	PC6T	1T/S	1,250	1,500	I	
PC-7 Turbo Trainer (AT-92, Astra)	PC7	1T/S	2,800		I	1
PC-9, Hudurnik	PC9	1T/S			I	
PC-12, Eagle	PC12	1T/S	1,900		I	4

PIPER AIRCRAFT CORP. (USA)*(Also AEROSTAR, AICSA, CHINCUL, COLEMILL, EMBRAER, INDAER CHILE, JOHNSTON, MACHEN, MILLER, NIEVA, SCHAFFER, SEGUIN, PZL-MIELEC, TED SMITH, WAGAERO)*

Model	Type Designator	Description	Performance Information			
			Number & Type Engines/ Weight Class	Climb Rate (fpm)	Descent Rate (fpm)	SRS Cat.
AP-60, Aerostar	AEST	2P/S	1,500	1,500	II	
J-2 Cub	J2	1P/S	500	500	I	1
J-3 Cub (L-4, NE)	J3	1P/S	500	500	I	1
J-4 Cub Coupe	J4	1P/S	500	500	I	1
J-5 Cub Cruiser (L-14, AE)	J5	1P/S	500	500	I	1
PA-11 Cub Special (L-18B)	PA11	1P/S	500	500	I	1
PA-12 Super Cruiser	PA12	1P/S	600	600	I	1
PA-14 Family Cruiser	PA14	1P/S	600	600	I	1
PA-15 Vagabond	PA15	1P/S	500	500	I	1
PA-16 Clipper	PA16	1P/S	500	500	I	1
PA-17 Vagabond, Vagabond Trainer	PA17	1P/S	500	500	I	1
PA-18 Super Cub (L-18C, L-21, U-7)	PA18	1P/S	1,000	1,000	I	1
PA-20 Pacer	PA20	1P/S	850	1,000	I	1
PA-22 Tri-Pacer, Caribbean, Colt	PA22	1P/S	1,000	1,000	I	2
PA-23-150/160 Apache	PA23	2P/S	1,050	1,000	II	2
PA-24 Comanche	PA24	1P/S	900	1,000	I	4

Model	Type Designator	Description	Performance Information			
			Number & Type Engines/ Weight Class	Climb Rate (fpm)	Descent Rate (fpm)	SRS Cat.
PA-25 Pawnee	PA25	1P/S	650	650	I	1
PA-23-235/250 Aztec, Turbo Aztec (U-11, E-19, UC-26)	PA27	2P/S	1,500	1,500	II	3
PA-28-140/150/151/ 160/161/180/181 Archer, Cadet, Cherokee, Cherokee Archer/ Challenger/Chief/Cruiser/Flite Liner/ Warrior	P28A	1P/S	750	1,000	I	1
PA-28-201T/235/236 Cherokee, Cherokee Charger/Pathfinder, Dakota, Turbo Dakota	P28B	1P/S	900	1,000	I	3
PA-28R-1802/3, Turbo Arrow 3/200/201 Cherokee Arrow, Arrow	P28R	1P/S	750	1,000	I	3
PA-28RT Arrow 4, Turbo Arrow 4	P28T	1P/S	900	1,000	I	2
PA-30/39 Twin Comanche, Twin Comanche CR, Turbo Twin Comanche	PA30	2P/S	1,500	1,500	II	1
PA-31/31P Navajo, Navajo Chieftain, Chieftain, Pressurized Navajo, Mohave, T-1020	PA31	2P/S	1,500	1,500	II	2
PA-32 Cherokee Six, Six, Saratoga, Turbo Saratoga, 6, 6XT	PA32	1P/S	850	1,000	I	3
PA-32R Cherokee Lance, Lance, Saratoga SP/2 HP/2TC, Turbo Saratoga SP	P32R	1P/S	850	1,000	I	3
PA-32RT Lance 2, Turbo Lance 2	P32T	1P/S	850	1,000	I	4
PA-34 Seneca	PA34	2P/S	1,300	1,300	II	7
PA-36 Pawnee Brave	PA36	1P/S	800	1,000	I	2
PA-38 Tomahawk	PA38	1P/S	750	750	I	3
PA-44, Seminole, Turbo Seminole	PA44	2P/S	1,100	1,000	II	2
PA-46 310P/350P Malibu, Malibu Mirage	PA46	1P/S	1,000	1,000	I	4
PA-46-500TP Malibu Meridian	P46T	1T/S	1,500	1,500	I	4
PA-31T3-500 T-1040	PAT4	1P/S	1,300	1,200	I	
PA-31T1-500 Cheyenne 1	PAY1	2T/S	2,200	2,000	II	5
PA-31T-620.T2-620 Cheyenne, Cheyenne 2	PAY2	2T/S	2,400	2,000	II	2
PA-42-720 Cheyenne 3	PAY3	2T/S	2,400	2,000	II	8
PA-42-1000 Cheyenne 400	PAY4	2T/S	2,500	2,000	II	4
PA-28R-300 Pillán	PILL	1P/S	750	1,000	I	
108 Voyager, Station Wagon 108	S108	1P/S	800	800	I	2

PITTS AEROBATICS (Manufactured by Christen Industries, Inc.)(USA)*(Also AEROTEK, AVIAT, CHRISTEN, KIMBALL)*

Model	Type Designator	Description	Performance Information			
			Number & Type Engines/ Weight Class	Climb Rate (fpm)	Descent Rate (fpm)	SRS Cat.
S-1 Special	PTS1	1P/S	1,500	1,500	I	
S-1-11 Super Stinker	PTSS	1P/S			I	
S-2 Special	PTS2	1P/S	1,500	1,500	I	
S-12 Macho Stinker, Super Stinker	PTMS	1P/S			I	

RAYTHEON (See BEECH)**ROBIN (France)***(Also APEX)*

Model	Type Designator	Description	Performance Information			
			Number & Type Engines/ Weight Class	Climb Rate (fpm)	Descent Rate (fpm)	SRS Cat.
R-1180 Aiglon	R100	1P/S			I	
R-2100/2112/2120/2160, Alpha, Alpha Sport, Super Club	R200	1P/S			I	
R-300/3000/3100/3120/3140	R300	1P/S			I	

ROCKWELL INTERNATIONAL CORP. (USA)*(Also AERO COMMANDER, CANADAIR, CCF, COMMANDER, COMMONWEALTH, GULFSTREAM, HAMILTON, MITSUBISHI, NOORDUYN, NORTH AMERICAN PACAERO, NORTH AMERICAN ROCKWELL, PACIFIC AIRMOTIVE, ROCKWELL, RYAN, SUD, TUSCO)*

Model	Type Designator	Description	Performance Information			
			Number & Type Engines/ Weight Class	Climb Rate (fpm)	Descent Rate (fpm)	SRS Cat.
100 Commander 100	VO10	1P/S	850	850	I	1
112, 114 Commander 112/114, Alpine Commander, Gran Turismo Commander	AC11	1P/S	1,000	1,200	I	2
200 Commander 200	M200	1P/S	1,400	1,000	I	1
500 Shrike Commander	AC50	2P/S	1,340	1,500	II	3
Commander 520	AC52	2P/S	1,340	1,500	II	1
560 Commander 560	AC56	2P/S	1,400	1,500	II	4
680F, 680FP, Commander 680F/680FP	AC68	2P/S	1,375	1,375	II	5
680FL, Grand Commander, Commander 685	AC6L	2P/S	1,250	1,250	II	6
720 Alti-Cruiser	AC72	2P/S	1,300	1,300	II	4
680T, 680V Turbo Commander	AC80	2T/S	2,000	1,500	II	4
690 Turbo Commander 690, Jetprop Commander 840	AC90	2T/S	2,500	2,500	II	6
695 Jetprop Commander 980/1000	AC95	2P/S	2,500	2,500	II	6
700, 710 Commander 700/710	RC70	2P/S			II	
AC-130 Spectre	C130	4T/L	1,500	1,500	III	
B-1 Lancer	B1*	4J/H	3,000	5,000	III	
FR-06 Fanranger, Ranger 2000	R2TH	1J/S			III	
Mitchell	B25	2P/L	980	980	III	
Sabre	F86*	1J/L	4,000	4,000	III	

Model	Type Designator	Description	Performance Information			
			Number & Type Engines/ Weight Class	Climb Rate (fpm)	Descent Rate (fpm)	SRS Cat.
Jet Commander 1121	JCOM	2J/S+	5,000	4,500	III	9
Lark 100 Commander	LARK	1P/S	700	1,000	I	1
Navion NA 145/154	NAVI	1P/S	750	600	I	2
Mustang	P51	1P/S	2,500	2,500	III	
NA-265 Sabre 40/60/65	SBR1	2J/S+	4,000	3,500	III	
NA-265 Sabre 75/80	SBR2	2J/S+			III	
OV-10 Bronco	V10	2T/S	2,000	2,500	II	
S-2 Thrush Commander	SS2P	1P/S			I	
Super Sabre F-100	SSAB	1J/L	4,000	4,000	III	
T-2 Buckeye	T2*	2J/L	5,700	6,000	III	
Trojan, Nomair, Nomad	T28	1P/S	2,500	2,500	III	
Texan, Harvard	T6	1P/S	800	800	I	2
Darter 100	VO10	1P/S	850	850	I	
X-31	X31	1J/S+			III	

RUSCHMEYER (FRG)

Model	Type Designator	Description	Performance Information			
			Number & Type Engines/ Weight Class	Climb Rate (fpm)	Descent Rate (fpm)	SRS Cat.
R-90-230FG	R90F	1P/S	1,000	1,000	I	
R-90-230RG, MF-85	R90R	1P/S	1,000	1,000	I	
R-90-420AT	R90T	1T/S	1,100	1,100	I	

SAAB (Sweden/USA)*(Also SAAB-FAIRCHILD)*

Model	Type Designator	Description	Performance Information			
			Number & Type Engines/ Weight Class	Climb Rate (fpm)	Descent Rate (fpm)	SRS Cat.
29 (J29)	SB29	1J/S			III	
32 Lansen (J32)	SB32	1J/S+			III	
35 Draken (J35, Sk35, F-35, RF-35, TF-35)	SB35	1J/S+			III	
37 Viggen (AJ37, AJS37, JA37, SP37, SH37, Sk37)	SB37	1J/S+			III	
39 Gripen (JAS39)	SB39	1J/S+			III	
91 Safir (Sk50)	SB91	1J/S			III	
105 (Sk60)	SB05	2J/S			III	
340	SF34	2T/L	2,000	2,000	III	5
2000	SB20	2T/L			III	
MFI-15/17 Safari, Supporter (T-17)	MF17	1P/S			I	

SHORT BROTHERS LTD. (UK)

Model	Type Designator	Description	Performance Information			
			Number & Type Engines/ Weight Class	Climb Rate (fpm)	Descent Rate (fpm)	SRS Cat.
330, Sherpa (C-23), SD3-30	SH33	2T/S+	1,380	1,380	III	6
360, SD3-60	SH36	2T/S+	1,400	1,400	III	6
SC-5 Belfast	BELF	4T/L			III	
SC7 Skyvan, Skyliner	SC7	2T/S	1,500	1,500	II	2

SILVAIRE (USA)*(Also LUCSOME, TEMCO)*

Model	Type Designator	Description	Performance Information			
			Number & Type Engines/ Weight Class	Climb Rate (fpm)	Descent Rate (fpm)	SRS Cat.
8 Silvaire	L8	1P/S	900	1,000	I	3

SOCATA (See AEROSPATIALE)**STINSON (USA)***(Also PIPER)*

Model	Type Designator	Description	Performance Information			
			Number & Type Engines/ Weight Class	Climb Rate (fpm)	Descent Rate (fpm)	SRS Cat.
10, 105, HW-75, HW-80, Voyager	S10	1P/S	750	1,000	I	
108 Voyager, Station Wagon	S108	1P/S	750	1,000	I	
L-5, U-19, OY Sentinel (V-76)	L5	1P/S	750	750	I	
SR, V-77 Reliant (AT-19)	RELI	1P/S	700	700	I	3

SUD AVIATION (See Aerospatiale)**SWEARINGEN AVIATION (USA-see Fairchild Industries)****TAYLORCRAFT AVIATION CORP. (USA)***(Also TAYLOR KITS)*

Model	Type Designator	Description	Performance Information			
			Number & Type Engines/ Weight Class	Climb Rate (fpm)	Descent Rate (fpm)	SRS Cat.
15 Tourist, Foursome	TA15	1P/S	800	1,000	I	
19, F-19 Sportsman	TF19	1P/S	800	1,000	I	1
20 Ranchwagon, Topper, Seabird, Zephyr 400	TA20	1P/S	1,000	1,000	I	4
A	TAYA	1P/S			I	
BC, BF, BL, Ace, Sportsman, Traveller	TAYB	1P/S			I	
DC, DCO, DF, DL (O-57, L-2)	TAYD	1P/S			I	
F-21	TF21	1P/S	1,100	1,100	I	4
F-22 Classic, Tri-Classical, Ranger, Trooper, Tracker	TF22	1P/S	875		I	

TED SMITH AEROSTAR CORP. (USA)*(Also AEROSTAR, AICSA, MACHEN, PIPER)*

Model	Type Designator	Description	Performance Information			
		Number & Type Engines/ Weight Class	Climb Rate (fpm)	Descent Rate (fpm)	SRS Cat.	LAHSO Group
Aero Star	AEST	2P/S	1,800	1,500	II	5

VFW-FOKKER (Zentralgesellschaft VFW-Fokker mbH (FRG/Netherlands))

Model	Type Designator	Description	Performance Information			
		Number & Type Engines/ Weight Class	Climb Rate (fpm)	Descent Rate (fpm)	SRS Cat.	LAHSO Group
VFW 614	VF14	2J/L	3,100	3,000	III	8

VOUGHT CORP. (USA)*(Also GLOBE, LTV, TEMCO)*

Model	Type Designator	Description	Performance Information			
		Number & Type Engines/ Weight Class	Climb Rate (fpm)	Descent Rate (fpm)	SRS Cat.	LAHSO Group
A-7, TA-7 Corsair	A7*	1J/L	8,000	6,000	III	
Swift	GC1	1P/S	1,000	1,000	I	2

YAKOVLEV (RUSSIA)

Model	Type Designator	Description	Performance Information			
		Number & Type Engines/ Weight Class	Climb Rate (fpm)	Descent Rate (fpm)	SRS Cat.	LAHSO Group
Yak-40	YK40	3J/S+			III	8

ZENAIR (Canada)*(Also ZENITH)*

Model	Type Designator	Description	Performance Information			
		Number & Type Engines/ Weight Class	Climb Rate (fpm)	Descent Rate (fpm)	SRS Cat.	LAHSO Group
CH-600/601 Zodiac, Super Zodiac	CH60	1P/S			I	
CH-620 Gemini	CH62	2P/S			II	
CH-801 Stol	CH80	1P/S			I	
CH-2000 Zenith	CH2T	1P/S	780		I	

Appendix B.

Aircraft Information

Helicopters/Rotorcrafts

TYPE ENGINE ABBREVIATIONS

P	piston
T	jet/turboprop
J	jet

CLIMB AND DESCENT RATES

Climb and descent rates based on average en route climb/descent profiles at median weight between maximum gross takeoff and landing weights.

SRS

SRS means “same runway separation;” categorization criteria is specified in para 3–9–6, Same Runway Separation.

MANUFACTURERS

Listed under the primary manufacturer are other aircraft manufacturers who also make versions of some of the aircraft in that group.

AEROSPATIALE (France)

(Also ATLAS, CASA, CHANGHE, EUROCOPTER, HELIBRAS, HINDUSTAN, IAR, ICA, NURTANIO, NUSANTARA, REPUBLIC, SINGAPORE, SUD, WESTLAND)

Model	Type Designator	Description	Performance Information		
		Number & Type Engines/ Weight Class	Climb Rate (fpm)	Descent Rate (fpm)	SRS Cat.
Lama SA–315	LAMA	1T/S	1,000	1,000	I
Alouette 2	ALO2	1T/S	1,280	1,280	I
Alouette 3	ALO3	1T/S	1,500	1,500	I
Dauphine SA–360/361	S360	1T/S	1,400	1,500	I
Dauphine 2 SA–365C	S65C	2T/S	1,800	1,000	I
Ecurevil/AStar AS–350/550	AS50	1T/S	1,000	1,000	I
Gazelle SA–341/342	GAZL	1T/S	1,620	1,620	I
Puma SA–330 (CH–33, HT–19)	PUMA	2T/L	1,250	1,500	I
Super Puma AS 332/532, SA–330)	AS32	2T/L	1,250	1,500	I
Super Frelon SA–321/Z–8	FREL	3T/L	1,200	1,500	I
Twin Star AS–355/555	AS55	2T/S	1,350	1,300	I

AUGUSTA (Constuzioni Aeronautiche Giovanni Agusta SpA) (Italy)

(Also BELL, NUSANTARA, SABCA)

Model	Type Designator	Description	Performance Information		
		Number & Type Engines/ Weight Class	Climb Rate (fpm)	Descent Rate (fpm)	SRS Cat.
Model 147J–3B–1, Ranger	B47J	1P/S	500	500	I
Model A 109/A/A–II	A109	2T/S	1,620	1,500	I
Model 212 ASW, Griffon	B12	2T/S	1,420	1,420	I

BELL/BOEING

Model	Type Designator	Description	Performance Information		
		Number & Type Engines/ Weight Class	Climb Rate (fpm)	Descent Rate (fpm)	SRS Cat.
Osprey	V22	2P/L	–	–	II

BELL HELICOPTER TEXTRON (USA)*(Also AGUSTA, AIDC, COMMONWEALTH, DORNIER, FUJI, GLOBAL, KAWASAKI, NUSANTARA, TROOPER, UNC, WESTLAND)*

Model	Type Designator	Description	Performance Information		
		Number & Type Engines/ Weight Class	Climb Rate (fpm)	Descent Rate (fpm)	SRS Cat.
Biglifter, Bell 204 ,205, 214A/B, AB-204	UH1	1T/S	1,500	1,500	I
Cobra	HUCO	1T/S	1,375	1,375	I
Jet Ranger/Long Ranger/ Sea Ranger/Kiowa/Model 206, Com- bat Scout	B06	1T/S	1,200	1,000	I
Huey/Iroquois/Model 205 A-1	UH1	1T/S	1,500	1,500	I
Ranger Model 47J	B47J	1P/S	1,000	1,000	I
Sioux/Model 47G, OH-13	B47G	1P/S	1,000	1,000	I
Twin Huey, Model 212, Model 214B/B-1, Model 412, Griffon	B12	2T/S	1,420	1,420	I
Model 214ST, Super Transport	BSTP	2T/S	1,420	1,420	I
Model 222, 230, 430	B222	2T/S	1,500	1,000	I

BOEING VERTOL COMPANY (USA)*(Also BOEING HELICOPTERS, KAWASAKI, MERIDIONALI, VERTOL)*

Model	Type Designator	Description	Performance Information		
		Number & Type Engines/ Weight Class	Climb Rate (fpm)	Descent Rate (fpm)	SRS Cat.
Chinook, Model 234	H47	2T/L	1,500	1,500	I
Sea Knight 107, CH-113, Labrador	H46	2T/S+	2,130	2,130	I

BOLKOW (Germany)*(Also CASA, EUROCOPTER, MBB, MESSERSCHMITT-BOLKOW, NURTANIO, NUSANTARA, PADC)*

Model	Type Designator	Description	Performance Information		
		Number & Type Engines/ Weight Class	Climb Rate (fpm)	Descent Rate (fpm)	SRS Cat.
Model 105, BO-105	B105	2T/S	1,500	1,500	I

BRANTLEY-HYNES HELICOPTER, INC. (USA)*(Also BRANTLEY, HYNES)*

Model	Type Designator	Description	Performance Information		
		Number & Type Engines/ Weight Class	Climb Rate (fpm)	Descent Rate (fpm)	SRS Cat.
Model B-2/A/B, H-2	BRB2	1P/S	1,400	1,400	I
Model 305	B305	1P/S	1,300	1,300	I

ENSTROM CORP. (USA)*(Also WUHAN)*

Model	Type Designator	Description	Performance Information		
		Number & Type Engines/ Weight Class	Climb Rate (fpm)	Descent Rate (fpm)	SRS Cat.
Falcon/Model F-28/A/C/F, Sentinel/ Model F-28-FP, Model 280, Shark	EN28	1P/S	800	800	I
Shark/Model 280FX, 28, Falcon, Sentinel	EN28	1P/S	1,200	1,200	I
Turbo Shark 480, TH-28	EN48	1P/S	1,500	1,500	I

FAIRCHILD/REPUBLIC (includes Hiller) (USA)*(Also FAIRCHILD HILLER, ROGERSON HILLER)*

Model	Type Designator	Description	Performance Information		
		Number & Type Engines/ Weight Class	Climb Rate (fpm)	Descent Rate (fpm)	SRS Cat.
Hiller UH-12/Raven, HTE	UH12	1P/S	1,500	1,500	I

HILLER (See FAIRCHILD/REPUBLIC (USA))**HUGHES HELICOPTERS (See MCDONNELL-DOUGLAS HELICOPTERS (USA))****KAMAN AEROSPACE CORPORATION (USA)**

Model	Type Designator	Description	Performance Information		
		Number & Type Engines/ Weight Class	Climb Rate (fpm)	Descent Rate (fpm)	SRS Cat.
H-2 Seasprite, Super Seasprite	H2	2T/L	2,400	2,400	I
Huskie 600-3/5	H43B	1T/L	2,000	2,000	I

KAWASAKI HEAVY INDUSTRIES LTD. (Japan)*(Also BOEING VERTOL, VERTOL)*

Model	Type Designator	Description	Performance Information		
		Number & Type Engines/Weight Class	Climb Rate (fpm)	Descent Rate (fpm)	SRS Cat.
KV-107/II, Sea Knight, Labrador, Voyager, CH-113	H46	2T/S+	1,500	1,500	I

MCDONNELL-DOUGLAS HELICOPTERS (includes Hughes Helicopters) (USA)*(Also AGUSTA, BREDANARDI, KAWASAKI, KOREAN AIR, NARDI, RACA, SCHWEIZER)*

Model	Type Designator	Description	Performance Information		
		Number & Type Engines/ Weight Class	Climb Rate (fpm)	Descent Rate (fpm)	SRS Cat.
Model 77/Apache, Pethen, Longbow Apache	H64	2T/S+	1,500	1,500	I
Model 269, 200, 280, 300, Skynight, TH-55 Osage	H269	1P/S	1,000	1,000	I
Model 300/C	H269	1P/S	1,200	1,200	I
Model 500C, 369, 530F, Defender, Black Tiger, Night Fox, Lifter	H500	1P/S	1,500	1,500	I
Osage	H269	1P/S	1,000	1,000	I
Pawnee, Model 369, Model 500D/ MD/MG	H500	1T/S	1,500	1,500	I

MESSERSCHMIDT-BOLKOW-BLOHM (MBB) (FRG)*(Also BOLKOW, CASA, EUROCOPTER, MBB, NURTANIO, NUSANTARA, PADC)*

Model	Type Designator	Description	Performance Information		
		Number & Type Engines/ Weight Class	Climb Rate (fpm)	Descent Rate (fpm)	SRS Cat.
Model BO 105	B105	2T/S	1,200	1,200	I

MBB/KAWASAKI (FRG/Japan)

Model	Type Designator	Description	Performance Information		
		Number & Type Engines/ Weight Class	Climb Rate (fpm)	Descent Rate (fpm)	SRS Cat.
Model BK 117	BK17	2T/S	1,500	1,500	I

ROBINSON HELICOPTER COMPANY INC. (USA)

Model	Type Designator	Description	Performance Information		
		Number & Type Engines/ Weight Class	Climb Rate (fpm)	Descent Rate (fpm)	SRS Cat.
Model R22	R22	1P/S	800	800	I

SCHWEIZER AIRCRAFT CORP. (USA)*(Also BREDANARDI, HUGHES, KAWASAKI, NARDI)*

Model	Type Designator	Description	Performance Information		
		Number & Type Engines/ Weight Class	Climb Rate (fpm)	Descent Rate (fpm)	SRS Cat.
Model 269C, 200, 280, 300, Skynight	H269	1P/S	1,000	1,000	I
269D, 330, 333	S330	1T/S			I

SIKORSKY AIRCRAFT (USA)*(Also AGUSTA, ASTA, HAWKER DE HAVILLAND, HELIPRO, KOREAN AIR, MITSUBISHI, TUSAS, UNITED CANADA, VAT, WESTLAND)*

Model	Type Designator	Description	Performance Information		
		Number & Type Engines/ Weight Class	Climb Rate (fpm)	Descent Rate (fpm)	SRS Cat.
Blackhawk S-70, WS-70, Seahawk, Pavehawk, Rescuehawk, Thunderhawk, Jayhawk, Oceanhawk, Deserthawk, Yanshuf, LAMPS MK3, Blackhawk	H60	2T/S+	2,000	2,000	I
Chickasaw S-55, H-19, HO4S, HRS	S55P	1P/S	800	1,000	I
Choctaw/Seashore/Seaboat S-58, CH-34	S58P	1P/L	1,120	1,120	I
Model S-51	S51	1P/L	1,000	1,000	I
Model S-52, Hummingbird	S52	1P/L	950	1,000	I
Model S-62	S62	1T/S	1,020	1,000	I
Model S-76, Spirit, Eagle	S76	2T/S	1,300	1,300	I
S-61R (CH-3, HH-3, Pelican)	S61R	2T/L	1,500	1,500	I
S-61A/B/D/L/N Sea King, Commando, CH-124	S61	2T/L	1,500	1,500	I
Sea Stallion S-65, Yasur	H53	2T/L	1,500	1,500	I
Skycrane S-64E/F, Tarhe S-64	S64	2T/L	1,300	1,300	I

WESTLAND HELICOPTERS LTD. (UK)

Model	Type Designator	Description	Performance Information		
		Number & Type Engines/Weight Class	Climb Rate (fpm)	Descent Rate (fpm)	SRS Cat.
WG 30	WG30	2T/S	1,200	1,200	I

Appendix C.

Aircraft Information

Specific Homebuilt/Experimental Aircraft

Homebuilt and Experimental Aircraft*

Designator Criteria	Type Designator	Performance Information**		
		Climb Rate (fpm)	Descent Rate (fpm)	SRS Cat.
Aircraft with cruise (indicated) airspeeds of 100 knots or less	HXA	500	500	I
Aircraft with cruise (indicated) airspeeds of greater than 100 knots, up to and including 200 knots	HXB	750	750	I
Aircraft with cruise (indicated) airspeeds greater than 200 knots	HXC	1,000	1,000	I

NOTE-

**Configuration diversity and the fact that airworthiness certificates are issued to aircraft builders, vice manufacturers, necessitates the assignment of generic aircraft type designators based on cruise performance, rather than specific manufacturer and normal descriptive/performance information.*

***All performance criteria has been estimated because configuration diversity precludes determining precise aircraft-specific information.*

Appendix D.

Standard Operating Practice (SOP) for the Transfer of Position Responsibility

1. PURPOSE

This appendix prescribes the method and step-by-step process for conducting a position relief briefing and transferring position responsibility from one specialist to another.

2. DISCUSSION

a. In all operational facilities, the increase in traffic density and the need for the expeditious movement of traffic without compromising safety have emphasized the importance of the position relief process.

b. The contents, methods, and practices used for position relief and briefings vary among personnel, and pertinent information is often forgotten or incompletely covered. Major problems occur whenever there is a heavy reliance upon memory, unsupported by routines or systematic reminders. This SOP addresses the complete task of transferring position responsibility and the associated relief briefing.

c. Position relief unavoidably provides workload for specialists at the time of relief. The intent of this SOP is to make the transfer of position responsibility take place smoothly and to ensure a complete transfer of information with a minimum amount of workload. The method takes advantage of a self-briefing concept in which the relieving specialist obtains needed status information by reading from the Status Information Area/s to begin the relief process. Up to the moment information related to the control of aircraft or vehicular movements requires verbal exchanges between specialists during the relief process. The method also specifies the moment when the transfer of position responsibility occurs.

d. In the final part of the relief process, the specialist being relieved monitors and reviews the position to ensure that nothing has been overlooked or incorrectly displayed and that the transfer of position responsibility occurred with a complete briefing.

3. TERMS

The following terms are important for a complete understanding of this SOP:

a. Status Information Area (SIA). Manual or automatic displays of the current status of position related equipment and operational conditions or procedures.

b. Written Notes. Manually recorded items of information kept at designated locations on the position of operation. They may be an element of the Status Information Area/s.

c. Checklist. An ordered listing of items to be covered during a position relief.

4. PRECAUTIONS

a. Specialists involved in the position relief process should not rush or be influenced to rush.

b. During position operation, each item of status information which is or may be an operational factor for the relieving specialist should be recorded as soon as it is operationally feasible so that it will not be forgotten or incorrectly recorded.

c. Extra care should be taken when more than one specialist relieves or is being relieved from a position at the same time; e.g., combining or decombining positions. Such simultaneous reliefs should be approached with caution.

5. RESPONSIBILITIES

a. The specialist being relieved shall be responsible for ensuring that any pertinent status information of which he/she is aware is relayed to the relieving specialist and is either:

- 1. Accurately displayed in the Status Information Area/s for which he/she has responsibility, or
- 2. Relayed to the position having responsibility for accurately displaying the status information.

b. The relieving specialist shall be responsible for ensuring that, prior to accepting responsibility for the position, any unresolved questions pertaining to the operation of the position are resolved.

c. The relieving specialist and the specialist being relieved shall share equal responsibility for the completeness and accuracy of the position relief briefing.

d. The specialists engaged in a position relief shall conduct the relief process at the position being relieved unless other procedures have been established and authorized by the facility air traffic manager.

NOTE-
The “sharing” of this responsibility means that the specialist being relieved is obligated to provide a complete, accurate briefing and the relieving specialist is obligated to ensure that a briefing takes place and is to his/her total satisfaction.

6. STEP-BY-STEP PROCESS

a. PREVIEW THE POSITION

Relieving Specialist	Specialist Being Relieved
1. Follow checklist and review the Status Information Area(s).	
NOTE- <i>This sub-step may be replaced by an authorized pre-position briefing provided an equivalent review of checklist items is accomplished.</i>	
2. Observe position equipment, operational situation, and the work environment. 3. Listen to voice communications and observe other operational actions. 4. Observe current and pending aircraft and vehicular traffic and correlate with flight and other movement information. 5. Indicate to the specialist being relieved that the position has been previewed and that the verbal briefing may begin.	
NOTE- <i>Substeps 6a2, 3, and 4 may be conducted concurrently or in any order.</i>	

b. VERBAL BRIEFING

Relieving Specialist	Specialist Being Relieved
<p>3. Ask questions necessary to ensure a complete understanding of the operational situation.</p>	<p>1. Brief the relieving specialist on the abnormal status of items not listed on the Status Information Area(s) as well as on any items of special interest calling for verbal explanation or additional discussion.</p> <p>2. Brief on traffic if applicable.</p> <p>4. Completely answer any questions asked.</p>

c. ASSUMPTION OF POSITION RESPONSIBILITY

Relieving Specialist	Specialist Being Relieved
<p>1. Make a statement or otherwise indicate to the specialist being relieved that position responsibility has been assumed.</p>	<p>2. Release the position to the relieving specialist.</p>

d. REVIEW THE POSITION

Relieving Specialist	Specialist Being Relieved
<p>1. Sign-on the position unless a facility directive authorizes substep 6d8.</p> <p>2. Check, verify, and update the information obtained in steps 6a and b.</p> <p>3. Check position equipment in accordance with existing directives.</p>	<p>4. Review checklist, Status Information Area/s, written notes, and other prescribed sources of information and advise the relieving specialist of known omissions, updates, or inaccuracies.</p> <p>5. Observe overall position operation to determine if assistance is needed.</p> <p>6. If assistance is needed, provide or summon it as appropriate.</p> <p>7. Advise the appropriate position regarding known Status Information Area(s) omissions, updates, or inaccuracies.</p> <p>8. Sign-on the relieving specialist if appropriate.</p> <p>9. Sign off the position in accordance with existing directives or otherwise indicate that the relief process is complete.</p>

Index

[References are to page numbers]

A

- Abbreviated Departure Clearance, 4-3-3
- Abbreviated Transmissions, 2-4-2
- Abbreviations, 1-2-3
- Additional Separation for Formation Flights, 5-5-4
- Adjacent Airspace, 5-5-5
- Adjusted Minimum Flight Level, 4-5-2
- Advance Descent Clearance, 4-7-1
- Aerial Refueling, 9-3-5
- Air Defense Exercise Beacon Code Assignment, 5-2-4
- Air Defense Identification Zone (Land Based), 9-3-4
- Air Traffic Service (ATS) Routes, 2-5-1
- Air Traffic Services Interfacility Data Communications (AIDC), 8-2-1
- Airborne Military Flights, 2-2-4
- Aircraft Bomb Threats, 10-2-4
- Aircraft Carrying Dangerous Materials, 9-3-1
- Aircraft Equipment Suffix (Strips), 2-3-9
- Aircraft Identification, 2-4-8
- Aircraft Identity (Strips), 2-3-8
- Aircraft Information (Experimental), C-1
- Aircraft Information (Fixed-Wing), A-1
- Aircraft Information (Helicopters), B-1
- Aircraft Information (Homebuilt), C-1
- Aircraft Information (Rotorcraft), B-1
- Aircraft Orientation, 10-2-1
- Aircraft Position Plots, 10-3-2
- Aircraft Type (Strips), 2-3-9
- Aircraft Types, 2-4-11
- Airport Conditions, 3-3-1 , 4-7-5
- Airport Ground Emergency, 10-1-2
- Airport Lighting, 3-4-1
- Airport Surface Detection Procedures, 3-6-1
- Airspace Classes, 2-4-11
- AIT, 5-4-5
- Alignment Accuracy Check (Radar), 5-1-1
- ALNOT, 10-3-2
- ALNOT Cancellation, 10-3-2
- ALS Intensity Settings, 3-4-2
- ALSF-2/SSALR, 3-4-3
- Alternative Routes, 4-4-3
- Altimeter Setting (Oceanic), 8-1-1
- Altimeter Settings, 2-7-1
- Altitude Amendments, 4-2-1
- Altitude and Distance Limitations, 4-1-1
- Altitude Assignment and Verification, 4-5-1
- Altitude Assignment for Military High Altitude Instrument Approaches, 4-8-5
- Altitude Confirmation – Mode C, 5-2-7
- Altitude Confirmation – Non-Mode C, 5-2-7
- Altitude Confirmation – Nonradar, 4-5-7
- Altitude Filters (Beacon), 5-2-8
- Altitude for Direction of Flight (IFR), 4-5-1
- Altitude for Direction of Flight (OTP), 7-3-2
- Altitude Instructions, 4-5-3
- Altitude Restricted Low Approach, 3-10-8
- ALTRV Clearance, 4-2-2
- ALTRV Information, 2-2-2
- Annotations, 1-2-3
- Anticipated Altitude Changes, 4-5-7
- Anticipating Separation (ATCT – Arrival), 3-10-6
- Anticipating Separation (ATCT – Departure), 3-9-3
- Approach Clearance Information, 4-8-6
- Approach Clearance Procedures, 4-8-1
- Approach Control Service for VFR Arriving Aircraft, 7-1-1
- Approach Information (Arrivals), 4-7-4
- Approach Lights, 3-4-2
- Approach Separation Responsibility, 5-9-5
- Approaches to Multiple Runways (Visual), 7-4-2

[References are to page numbers]

Arctic CTA, 8-10-1
 Arresting System Operations, 3-3-3
 Arrival Information, 4-7-3
 Arrival Information by Approach Control Facilities,
 4-7-5
 Arrival Instructions (Radar), 5-9-2
 Arrival Procedures, 4-7-1
 Arrival Procedures and Separation (ATCT),
 3-10-1
 Arrivals on Parallel or Nonintersecting Diverging
 Runways (Radar), 5-8-3
 ARTS, 5-15-1
 ATC Assigned Airspace, 9-4-1
 ATC Service, 2-1-1
 ATIS Application, 2-9-1
 ATIS Content, 2-9-2
 ATIS Procedures, 2-9-1
 Authorized Interruptions, 2-4-1
 Authorized Relays, 2-4-2
 Authorized Transmissions, 2-4-1
 Automated Information Transfer, 5-4-5
 Automated Radar Terminal Systems – Terminal,
 5-15-1
 Automatic Altitude Reporting, 5-2-7
 Automation – En Route, 5-14-1
 Avoidance of Areas of Nuclear Radiation, 9-3-8
 AWACS Special Flights, 9-3-8

B

Balloons, Unmanned Free, 9-7-1
 Beacon Code for Pressure Suit Flights and Flights
 Above FL 600, 5-2-4
 Beacon Code Monitor, 5-2-5
 Beacon Identification Methods, 5-3-1
 Beacon Range Accuracy, 5-1-2
 Beacon Systems, 5-2-1
 Beacon Target Displacement, 5-5-6
 Beacon Termination, 5-2-8

Below Minima Report by Pilot, 4-7-4
 Braking Action, 3-3-2
 Braking Action Advisories, 3-3-2

C

Calm Wind Conditions, 2-6-3
 Canadian Airspace Procedures, 12-1-1
 Cancellation of Takeoff Clearance, 3-9-8
 Caribbean ICAO Region, 8-8-1
 Celestial Navigation Training, 9-3-1
 Charted Visual Flight Procedures, 7-4-3
 Circling Approach, 4-8-5
 Class A Airspace Restrictions, 7-1-1
 Class B Separation, 7-9-2
 Class B Service Area (Terminal), 7-9-1
 Class C Separation, 7-8-1
 Class C Service (Terminal), 7-8-1
 Clearance Beyond Fix, 4-6-2
 Clearance Delivery Instructions, 4-2-1
 Clearance for Visual Approach, 7-4-1
 Clearance Information (Arrivals), 4-7-1
 Clearance Items, 4-2-1
 Clearance Items (Airfile), 4-2-3
 Clearance Limit, 4-8-5
 Clearance Prefix, 4-2-1
 Clearance Relay, 4-2-1
 Clearance Status (Strips), 2-3-9
 Clearance to Holding Fix, 4-6-1
 Clearance Void Times, 4-3-5
 Closed Runway Information, 3-3-1
 Closed Traffic, 3-10-8
 Coast Tracks, 5-14-2
 Communications Failure, 10-4-1
 Communications Release (Approaches), 4-8-6
 Composite Separation Minima (Oceanic), 8-9-2
 Computer Entry of Assigned Altitude, 5-14-1
 Computer Message Verification, 2-2-2
 Conflict Alert (Host), 5-14-1

[References are to page numbers]

Conflict Alert/Mode C Intruder (MCI) (ARTS),
5-15-2

Constraints Governing Supplements and Procedural
Deviations, 1-1-2

Contact Approach, 7-4-3

Control Estimates, 8-1-1

Control Symbology (Strip), 2-3-9

Control Transfer, 2-1-7

Controller Initiated Coast Tracks, 5-14-2

Controller Pilot Data Link Communications
(CPDLC), 2-4-4 , 4-5-4 , 13-2-3

Coordinate Use of Airspace, 2-1-6

Coordination Between Local and Ground
Controllers, 3-1-2

Coordination with Receiving Facility (Departures),
4-3-6

Course Definitions, 1-2-2

Crossing Altitude, 4-1-2

CVFP, 7-4-3

D

Decision Support Tools, 13-1-1

Degree – Distance Route Definition for Military
Operations, 4-4-2

Delay Sequencing (Departures), 4-3-6

Department of Energy Special Flights, 9-3-1

Departure and Arrival (Radar Separation), 5-8-3

Departure Clearances, 4-3-1

Departure Control Instructions (ATCT), 3-9-1

Departure Delay Information (ATCT), 3-9-1

Departure Information (ATCT), 3-9-1

Departure Procedures, 4-3-1

Departure Procedures and Separation (ATCT),
3-9-1

Departure Restrictions, 4-3-5

Departure Terminology, 4-3-1

Departures on Parallel or Nonintersecting Diverging
Runways (Radar), 5-8-3

Deviation Advisories (Protected Airspace), 5-1-4

Discrete Environment (Beacon), 5-2-1

Disseminating Weather Information, 2-6-4

DOE, 9-3-1

Duty Priority, 2-1-1

E

E-MSAW, 5-14-1

Edge of Scope, 5-5-5

Electronic Attack (EA) Activity, 5-1-2

Electronic Cursor, 5-1-3

ELP Operations, 3-10-9

ELT, 10-2-3

Emergencies, 10-1-1

Emergencies Involving Military Fighter-Type
Aircraft, 10-1-2

Emergency Airport Recommendation, 10-2-6

Emergency Assistance, 10-2-1

Emergency Code Assignment, 5-2-3

Emergency Control Actions, 10-4-1

Emergency Landing Pattern (ELP) Operations,
3-10-9

Emergency Lighting, 3-4-1

Emergency Locator Transmitter Signals, 10-2-3

Emergency Obstruction Video Map, 10-2-7

Emergency Procedures (Oceanic), 10-6-1

Emergency Situations, 10-2-1

Emphasis for Clarity, 2-4-4

En Route Data Entries (Strips), 2-3-3

En Route Fourth Line Data Block Usage, 5-4-5

En Route Minimum Safe Altitude Warning,
5-14-1

En Route Sector Team Responsibilities, 2-10-1

Entry of Reported Altitude, 5-14-2

EOVM, 10-2-7

Equipment on Runways, 3-1-2

Establishing Two-Way Communications (Class D),
3-1-5

Evasive Action Maneuvers, 9-3-9

Expeditious Compliance, 2-1-3

[References are to page numbers]

Experimental Aircraft Operations, 9-3-2
 Explosive Cargo, 10-5-1
 Explosive Detection K-9 Teams, 10-2-5

F

FAA Research and Development Flights, 9-3-2
 Facility Identification, 2-4-8
 Failed Transponder in Class A Airspace, 5-2-6
 Failure to Display Assigned Beacon Code, 5-2-5
 False or Deceptive Communications, 2-4-1
 Far Field Monitor (FFM) Remote Status Unit,
 3-3-4
 Final Approach Course Interception, 5-9-1
 Fix Use, 4-1-2
 Flight Check Aircraft, 9-1-1
 Flight Direction Exceptions, 4-5-2
 Flight Plans and Control Information, 2-2-1
 Flight Progress Strips, 2-3-1
 FLYNET, 9-3-2
 Formation Flight Additional Separation, 5-5-4
 Formation Flights, 2-1-6
 Forward Departure Delay Information, 4-3-6
 Forwarding Amended and UTM Data, 2-2-3
 Forwarding Approach Information by Nonapproach
 Control Facilities, 3-10-1
 Forwarding Departure Times, 4-3-7
 Forwarding Flight Plan Data Between U.S. ARTCCs
 and Canadian ACCs, 2-2-4
 Forwarding Information, 2-2-1
 Forwarding VFR Data, 2-2-1
 Fuel Dumping, 9-5-1
 Function Code Assignments, 5-2-2

G

GPA 102/103 Correction Factor, 5-5-6
 Ground Missile Emergencies, 10-7-1
 Ground Operations, 3-7-3

Ground Operations When Volcanic Ash is Present,
 3-1-6
 Ground Stop, 4-3-6
 Ground Traffic Movement, 3-7-1

H

Helicopter Arrival Separation, 3-11-3
 Helicopter Departure Separation, 3-11-2
 Helicopter Landing Clearance, 3-11-4
 Helicopter Operations, 3-11-1
 Helicopter Takeoff Clearance, 3-11-1
 High Intensity Runway Lights, 3-4-4
 High Speed Turnoff Lights, 3-4-4
 Hijacked Aircraft, 10-2-2
 HIRL, 3-4-4
 HIRL Associated with MALSR, 3-4-4
 HIRL Changes Affecting RVR, 3-4-4
 HIWAS, 2-6-1
 Hold for Release, 4-3-5
 Holding Aircraft, 4-6-1
 Holding Delays, 4-6-2
 Holding Flight Path Deviation, 4-6-3
 Holding Instructions, 4-6-3
 Holding Pattern Surveillance, 5-1-4
 Holding Points (Visual), 4-6-3

I

ICAO Phonetics, 2-4-5
 IFR – VFR Flights, 4-2-3
 IFR Flight Progress Data, 2-2-1
 IFR to VFR Flight Plan Change, 2-2-1
 ILS Protection/Critical Areas (Holding), 4-6-3
 Inflight Deviations from Transponder/Mode C
 Requirements Between 10,000 Feet and 18,000
 Feet, 5-2-8
 Inflight Equipment Malfunctions, 2-1-4
 Inhibiting Low Altitude Alert System (TPX-42),
 5-16-1

[References are to page numbers]

Inhibiting Minimum Safe Altitude Warning (ARTS),
5-15-2

Initial Heading, 5-8-1

Inoperative Interrogator, 5-2-6

Inoperative/Malfunctioning Transponder, 5-2-5

Interceptor Operations, 9-3-4

Interfacility Automated Information Transfer,
5-4-5

Interphone Message Format, 2-4-3

Interphone Message Termination, 2-4-4

Interphone Transmission Priorities, 2-4-2

Intersecting Runway Separation (Arrival), 3-10-3

Intersecting Runway Separation (Departure),
3-9-6

J

Jettisoning of External Stores, 9-6-1

K

K-9 Teams, 10-2-5

L

LAAS, 5-16-1

Landing Area Condition, 3-3-1

Landing Clearance, 3-10-6

Landing Clearance Without Visual Observation,
3-10-7

Landing Information (ATCT), 3-10-1

Lateral Separation (Nonradar), 6-5-1

Lateral Separation (Oceanic), 8-4-1

Law Enforcement Operations by Civil and Military
Organizations, 9-3-4

Light Signals (ATCT), 3-2-1

Longitudinal Separation (Nonradar), 6-4-1

Longitudinal Separation (Oceanic), 8-3-1

Low Approach, 4-8-7

Low Level Wind Shear/Microburst Advisories,
3-1-3

Lowest Usable Flight Level, 4-5-2

M

Mach Number Technique, 8-3-2

Malfunctioning Interrogator, 5-2-6

MALSR/ODALS, 3-4-2

Man-Portable Air Defense Systems (MANPADS)
Alert, 10-2-6

Manual Input of Computer Assigned Beacon Codes,
2-2-2

MEARTS, 5-1-1

Medium Intensity Runway Lights, 3-4-4

Merging Target Procedures, 5-1-3

Military DVFR Departures, 2-2-1

Military Operations above FL 600, 9-3-7

Military Procedures, 2-1-6

Military Single Frequency Approaches, 5-10-5

Military Special Use Frequencies, 9-3-7

Military Training Routes, 9-3-2

Minimum En Route Altitudes, 4-5-3

Minimum Fuel, 2-1-4

MIRL, 3-4-4

Missed Approach, 4-8-6

Missed Approach (Radar Approach), 5-10-4

Mixed Environment (Beacon), 5-2-1

Mode C Intruder Alert (Host), 5-14-1

Monitoring Radios, 2-4-1

MSAW, 5-15-2

N

NAVAID Fixes, 2-5-2

NAVAID Malfunctions, 2-1-5

NAVAID Terms, 2-5-1

NAVAID Use Limitations, 4-1-1

Navy Fleet Support Missions, 10-5-1

No-Gyro Approach, 5-10-2

[References are to page numbers]

Nondiscrete Environment (Beacon), 5-2-1
 Nonradar, 6-1-1
 Nonradar Initial Separation of Departing and Arriving Aircraft, 6-3-1
 Nonradar Initial Separation of Successive Departing Aircraft, 6-2-1
 Nonradar Timed Approaches, 6-7-1
 Nonstandard Formation/Cell Operations, 9-3-9
 NORAD Special Flights, 9-3-8
 North American ICAO Region, 8-10-1
 North American Route Program (NRP), 2-2-5
 North Atlantic ICAO Region, 8-7-1
 Notes, 1-2-2
 Number Clarification, 2-4-8
 Numbers Usage, 2-4-5

O

Observed Abnormalities, 3-1-5
 Obstruction Lights, 3-4-5
 Ocean21 ATC System, 13-2-1
 Oceanic Coordination, 8-2-1
 Oceanic Navigational Error Reporting (ONER) Procedures, 8-1-1
 Oceanic Procedures, 8-1-1
 Oceanic Separation, 8-1-1
 Oceanic Transition Procedures, 8-5-1
 Oceanic VFR Flight Plans, 8-1-1
 Offshore Procedures, 8-1-1
 Offshore Transition Procedures, 8-5-1
 Open Skies Treaty Aircraft, 9-3-9
 Operational Priority, 2-1-2
 Operational Requests, 2-1-8
 Overdue Aircraft, 10-3-1
 Overhead Maneuver, 3-10-8

P

Pacific ICAO Region, 8-9-1
 PAR Approaches – Terminal, 5-12-1

Parachute Operations, 9-8-1
 Parallel Dependent ILS/MLS Approaches, 5-9-5
 Passing or Diverging, 5-5-4
 Personnel on Runways, 3-1-2
 Pilot Acknowledgment/Read Back, 2-4-1
 PIREP Information, 2-6-1
 Point Out, 5-4-4
 Position Determination (Airports), 3-1-2
 Position Information (Radar), 5-3-2
 Position Report (Oceanic), 8-1-1
 Position Reporting (Radar), 5-1-4
 Position Responsibilities, 2-10-1
 Practice Approaches, 4-8-6
 Practice Precautionary Approaches, 3-10-9
 Prearranged Coordination, 5-4-5
 Precision Approach Critical Area, 3-7-4
 Precision Approach Path Indicators (PAPI), 3-4-1
 Preventive Control (Airports), 3-1-1
 Primary Radar Identification Methods, 5-3-1
 Priority Interruptions, 2-4-2
 Procedural Letters of Agreement, 1-1-2
 Procedural Preference, 2-1-1

Q

Questionable Identification, 5-3-2

R

Radar Approaches – Terminal, 5-10-1
 Radar Arrivals, 5-9-1
 Radar Beacon Changes for Military Aircraft, 4-7-2
 Radar Beacon Code Changes, 5-2-2
 Radar Departures, 5-8-1
 Radar Fix Posting, 5-1-4
 Radar Identification, 5-3-1
 Radar Identification Status, 5-3-2

[References are to page numbers]

Radar Presentation and Equipment Performance, 5-1-1
 Radar Separation, 5-5-1
 Radar Separation Application, 5-5-1
 Radar Separation Minima, 5-5-2
 Radar Separation Vertical Application, 5-5-3
 Radar Service Limitations, 5-1-3
 Radar Service Termination, 5-1-4
 Radar Use, 5-1-1
 Radio and Interphone Communications, 2-4-1
 Radio Communications, 2-4-1
 Radio Communications Transfer, 2-1-7
 Radio Failure (Beacon), 5-2-3
 Radio Frequency Changes for Military Aircraft, 4-7-2
 Radio Message Format, 2-4-2
 Receiver-Only Acknowledgment (ATCT), 3-2-1
 Receiving Controller Handoff, 5-4-3
 Recording Information, 2-2-1
 Reduced Vertical Separation Minimum (RVSM), 2-1-12
 Reduction of Route Protected Airspace (Oceanic), 8-4-3
 References, 1-2-3
 REIL, 3-4-1
 Relayed Approach Clearance, 4-8-5
 Release Times, 4-3-5
 Reporting Essential Flight Information, 2-1-5
 Reporting Weather Conditions, 2-6-3
 Responsibility Transfer to RCC, 10-3-2
 Rotating Beacon, 3-4-5
 Route Amendments, 4-2-1
 Route and NAVAID Description, 2-5-1
 Route Assignment, 4-4-1
 Route Structure Transitions, 4-4-2
 Route Use, 4-4-1
 Routes in Class G Airspace, 4-4-3
 Runway Centerline Lights, 3-4-4
 Runway Edge Lights, 3-4-3

Runway End Identifier Lights, 3-4-1
 Runway Exiting, 3-10-7
 Runway Proximity, 3-7-4
 Runway Selection, 3-5-1
 RVR/RVV, 2-8-1
 RVSM, 2-1-12

S

Safety Alert, 2-1-3
 Same Runway Separation (Arrival), 3-10-2
 Same Runway Separation (Departure), 3-9-3
 SAR, 10-3-1
 SAR Information to be Forwarded to ARTCC, 10-3-1
 SAR Information to be Forwarded to RCC, 10-3-1
 Sea Lane Operations, 3-12-1
 Search and Rescue, 10-3-1
 Sector Eligibility, 5-14-2
 Selected Altitude Limits, 5-14-2
 Separation from Airspace Reservations, 8-6-1
 Separation from Obstructions, 5-5-5
 Sequence/Spacing Application, 3-8-1
 Sequenced Flashing Lights, 3-4-2
 SFA, 4-7-1
 Side-Step Maneuver, 4-8-5
 Simulated Flameout (SFO) Approaches, 3-10-9
 Simultaneous Approach and Runway Edge Light Operation, 3-4-4
 Simultaneous Departures (Radar), 5-8-1
 Simultaneous Independent Dual ILS/MLS Approaches – High Update Radar, 5-9-9
 Simultaneous Independent ILS/MLS Approaches – Dual & Triple, 5-9-8
 Simultaneous Landings or Takeoffs (Helicopter), 3-11-3
 Simultaneous Opposite Direction Operation, 3-8-2
 Simultaneous Same Direction Operation, 3-8-1
 Single Frequency Approaches, 4-7-1

[References are to page numbers]

Spacing and Sequencing (ATCT), 3-8-1
 Special Flights, 9-1-1
 Special Interest Flights, 9-2-1
 Special Interest Sites, 9-3-4
 Special Operations, 9-3-1
 Special Use Airspace, 9-4-1
 Special VFR, 7-5-1
 Specifying Altitude (Approaches), 4-8-5
 Speed Adjustment, 5-7-1
 Speed Adjustment Minima, 5-7-3
 Speed Adjustment Termination, 5-7-3
 Standby or Low Sensitivity Operation, 5-2-5
 STOL Runways, 3-5-1
 Stop-and-Go Low Approach, 3-8-1
 Successive Departures (Radar), 5-8-1
 Surface Area Restrictions, 3-1-5
 Surface Areas, 2-1-7
 Surveillance Approaches – Terminal, 5-11-1
 SVFR, 7-5-1
 Switching ILS/MLS Runways, 4-7-6

T

Tailwind Components, 3-5-1
 Takeoff Clearance, 3-9-7
 Target Markers, 5-3-3
 Target Resolution, 5-5-1
 Target Separation, 5-5-1
 Taxi and Ground Movement Operations, 3-7-1
 Taxi and Ground Movement Procedures, 3-7-1
 Taxi into Position and Hold (TIPH), 3-9-2
 Taxiway Lights, 3-4-5
 Teletype Flight Data Format – U.S. ARTCCs –
 Canadian ACCs, 2-2-4
 Temporary Moving Airspace Reservations, 8-6-1
 Temporary Stationary Airspace Reservations,
 8-6-1
 Terminal Automation Systems Identification
 Methods, 5-3-2

Terminal Data Entries (Strips), 2-3-5
 Terminal Radar Service Area, 7-7-1
 Terminal Radar/Nonradar Team Position
 Responsibilities, 2-10-2
 Through Clearances, 4-2-2
 Timely Information (ATCT), 3-3-1
 Touch-and-Go Approach, 4-8-7
 Touch-and-Go Low Approach, 3-8-1
 Touchdown Zone Lights, 3-4-4
 Tower Team Position Responsibilities, 2-10-4
 TPX-42 – Terminal, 5-16-1
 Track Separation (Oceanic), 8-4-4
 Track Suspend Function (ARTS), 5-15-2
 Traffic Advisories, 2-1-9
 Traffic Information (Airports), 3-1-2
 Traffic Management Procedures, 11-1-1
 Transfer of Jurisdiction, 4-7-4
 Transfer of Position (SOP), D-1
 Transfer of Radar Identification, 5-4-1
 Transfer of Radar Identification – Methods,
 5-4-1
 Transfer of Radar Identification – Terms, 5-4-1
 Transfer of Radar Identification – Traffic, 5-4-2
 Transferring Controller Handoff, 5-4-2
 Transmit Proposed Flight Plan, 2-2-3
 TRSA, 7-7-1
 TRSA Separation, 7-7-1

U

Unidentified Flying Object (UFO) Reports, 9-9-1
 Unmanned Free Balloons, 9-7-1
 Unmonitored NAVAIDs (Holding), 4-6-3
 Unsafe Runway Information, 3-3-1
 USAF/USN Undergraduate Pilots (Strips), 2-3-9
 Use of Active Runways, 3-1-1
 Use of MARSAs, 2-1-5
 Use of PAR for Approach Monitoring – Terminal,
 5-13-1

[References are to page numbers]

Use of Tower Radar Displays, 3-1-4
 User Request Evaluation Tool (URET), 13-1-1

V

Validation of Mode C Readout, 5-2-6
 VASI, 3-4-1
 Vectoring, 5-6-1
 Vectors Across Final Approach Course, 5-9-2
 Vectors Below Minimum Altitude, 5-6-2
 Vectors for Visual Approach, 7-4-1
 Vectors to Final Approach Course, 5-9-1
 Vehicles on Runways, 3-1-2
 Vertical Application Exceptions, 5-5-3
 Vertical Separation (Nonradar), 6-6-1
 Vertical Separation Minima, 4-5-1
 VFR – IFR Flights, 4-2-3
 VFR Aircraft in Weather Difficulty, 10-2-2
 VFR Basic Radar Service (Terminal), 7-6-1
 VFR Code Assignments, 5-2-3
 VFR Conditions, 7-1-1
 VFR Release of IFR Departure, 4-3-7
 VFR-on-top, 7-3-1
 VFR-on-top (NAVAID Use), 4-1-2
 Visual, 7-1-1

Visual Approach Slope Indicators, 3-4-1
 Visual Approaches, 7-4-1
 Visual Holding of VFR Aircraft, 7-1-1
 Visual Separation, 7-2-1
 Visual Signals (ATCT), 3-2-1
 Visually Scanning Runways, 3-1-5
 Volcanic Ash, 10-2-7

W

Wake Turbulence, 2-1-9
 Wake Turbulence Cautionary Advisories, 2-1-9
 Wake Turbulence Separation for Intersection Departures, 3-9-5
 Warning Signal (ATCT), 3-2-1
 Weather and Chaff Services, 2-6-2
 Weather Deviations, 8-9-3
 Weather Deviations in North Atlantic (NAT) Airspace, 8-7-2
 Weather Familiarization, 2-6-1
 Weather Information, 2-6-1
 Weather Information (Arrivals), 4-7-3
 Weather Reconnaissance Flights, 9-3-8
 Withholding Landing Clearance, 3-10-7
 Word Meanings, 1-2-1
 Words and Phrases (Communications), 2-4-4

Offices of Primary Interest

Chapter 1. Introduction

Section 1. General

PARAGRAPH		OPI
1-1-1.	PURPOSE	ATP-100
1-1-2.	DISTRIBUTION	ATP-100
1-1-3.	CANCELLATION	ATA-10
1-1-4.	EXPLANATION OF MAJOR CHANGES	ATP-100
1-1-5.	EFFECTIVE DATE	ATA-10
1-1-6.	RECOMMENDATIONS FOR PROCEDURAL CHANGES	ATP-100
1-1-7.	PUBLICATION AND DELIVERY DATES	ATA-10
1-1-8.	PROCEDURAL LETTERS OF AGREEMENT	ATP-120
1-1-9.	CONSTRAINTS GOVERNING SUPPLEMENTS AND PROCEDURAL DEVIATIONS	ATP-120

Section 2. Terms of Reference

PARAGRAPH		OPI
1-2-1.	WORD MEANINGS	ATP/ARS
1-2-2.	COURSE DEFINITIONS	ATP-100
1-2-3.	NOTES	ATP-100
1-2-4.	REFERENCES	ATP-100
1-2-5.	ANNOTATIONS	ATP-100
1-2-6.	ABBREVIATIONS	All OPIs

Chapter 2. General Control

Section 1. General

PARAGRAPH		OPI
2-1-1.	ATC SERVICE	ATP-100
2-1-2.	DUTY PRIORITY	ATP-100
2-1-3.	PROCEDURAL PREFERENCE	ATP-100
2-1-4.	OPERATIONAL PRIORITY	ATP-100
2-1-5.	EXPEDITIOUS COMPLIANCE	ATP-120
2-1-6.	SAFETY ALERT	ATP-120
2-1-7.	INFLIGHT EQUIPMENT MALFUNCTIONS	ATP-110
2-1-8.	MINIMUM FUEL	ATP-110
2-1-9.	REPORTING ESSENTIAL FLIGHT INFORMATION	ATP-120
2-1-10.	NAVAID MALFUNCTIONS	ATP-110
2-1-11.	USE OF MARSA	ATP-200

PARAGRAPH		OPI
2-1-12.	MILITARY PROCEDURES	ATP-200
2-1-13.	FORMATION FLIGHTS	ATP-200
2-1-14.	COORDINATE USE OF AIRSPACE	ATP-110
2-1-15.	CONTROL TRANSFER	ATP-110
2-1-16.	SURFACE AREAS	ATP-120
2-1-17.	RADIO COMMUNICATIONS TRANSFER	ATP-110
2-1-18.	OPERATIONAL REQUESTS	ATP-120
2-1-19.	WAKE TURBULENCE	ATP-120
2-1-20.	WAKE TURBULENCE CAUTIONARY ADVISORIES	ATP-120
2-1-21.	TRAFFIC ADVISORIES	ATP-120
2-1-22.	BIRD ACTIVITY INFORMATION	ATP-120
2-1-23.	TRANSFER OF POSITION RESPONSIBILITY	ATP-110
2-1-24.	WHEELS DOWN CHECK	ATP-120
2-1-25.	SUPERVISORY NOTIFICATION	ATP-120
2-1-26.	PILOT DEVIATION NOTIFICATION	ATP-110
2-1-27.	TCAS RESOLUTION ADVISORIES	ATP-120
2-1-28.	RVSM OPERATIONS	ATO-E

Section 2. Flight Plans and Control Information

PARAGRAPH		OPI
2-2-1.	RECORDING INFORMATION	ATP-110
2-2-2.	FORWARDING INFORMATION	ATP-110
2-2-3.	FORWARDING VFR DATA	ATP-120
2-2-4.	MILITARY DVFR DEPARTURES	ATP-200
2-2-5.	IFR TO VFR FLIGHT PLAN CHANGE	ATP-110
2-2-6.	IFR FLIGHT PROGRESS DATA	ATP-110
2-2-7.	MANUAL INPUT OF COMPUTER-ASSIGNED BEACON CODES	ATP-110
2-2-8.	ALTRV INFORMATION	ATP-200
2-2-9.	COMPUTER MESSAGE VERIFICATION	ATP-110
2-2-10.	TRANSMIT PROPOSED FLIGHT PLAN	ATP-110
2-2-11.	FORWARDING AMENDED AND UTM DATA	ATP-110
2-2-12.	AIRBORNE MILITARY FLIGHTS	ATP-110
2-2-13.	FORWARDING FLIGHT PLAN DATA BETWEEN U.S. ARTCCs AND CANADIAN ACCs	ATP-110
2-2-14.	TELETYPE FLIGHT DATA FORMAT-U.S. ARTCCs - CANADIAN ACCs	ATP-110
2-2-15.	NORTH AMERICAN ROUTE PROGRAM (NRP) INFORMATION	ATP-110

Section 3. Flight Progress Strips

PARAGRAPH		OPI
2-3-1.	GENERAL	ATP-100
2-3-2.	EN ROUTE DATA ENTRIES	ATP-110
2-3-3.	TERMINAL DATA ENTRIES	ATP-120
2-3-4.	AIRCRAFT IDENTITY	ATP-120
2-3-5.	AIRCRAFT TYPE	ATP-120
2-3-6.	USAF/USN UNDERGRADUATE PILOTS	ATP-200
2-3-7.	AIRCRAFT EQUIPMENT SUFFIX	ATP-110
2-3-8.	CLEARANCE STATUS	ATP-100
2-3-9.	CONTROL SYMBOLOGY	ATP-100

Section 4. Radio and Interphone Communications

PARAGRAPH		OPI
2-4-1.	RADIO COMMUNICATIONS	ATP-100
2-4-2.	MONITORING	ATP-100
2-4-3.	PILOT ACKNOWLEDGMENT/READ BACK	ATP-100
2-4-4.	AUTHORIZED INTERRUPTIONS	ATP-100
2-4-5.	AUTHORIZED TRANSMISSIONS	ATP-100
2-4-6.	FALSE OR DECEPTIVE COMMUNICATIONS	ATP-100
2-4-7.	AUTHORIZED RELAYS	ATP-100
2-4-8.	RADIO MESSAGE FORMAT	ATP-100
2-4-9.	ABBREVIATED TRANSMISSIONS	ATP-100
2-4-10.	INTERPHONE TRANSMISSION PRIORITIES	ATP-100
2-4-11.	PRIORITY INTERRUPTION	ATP-100
2-4-12.	INTERPHONE MESSAGE FORMAT	ATP-100
2-4-13.	INTERPHONE MESSAGE TERMINATION	ATP-100
2-4-14.	WORDS AND PHRASES	ATP-100
2-4-15.	EMPHASIS FOR CLARITY	ATP-100
2-4-16.	ICAO PHONETICS	ATP-100
2-4-17.	NUMBERS USAGE	ATP-100
2-4-18.	NUMBER CLARIFICATION	ATP-100
2-4-19.	FACILITY IDENTIFICATION	ATP-100
2-4-20.	AIRCRAFT IDENTIFICATION	ATP-100
2-4-21.	DESCRIPTION OF AIRCRAFT TYPES	ATP-100
2-4-22.	AIRSPACE CLASSES	ATP-100

Section 5. Route and NAVAID Description

PARAGRAPH		OPI
2-5-1.	AIR TRAFFIC SERVICE (ATS) ROUTES	ATP-110
2-5-2.	NAVAID TERMS	ATP-100
2-5-3.	NAVAID FIXES	ATP-110

Section 6. Weather Information

PARAGRAPH		OPI
2-6-1.	FAMILIARIZATION	ATP-120
2-6-2.	HAZARDOUS INFLIGHT WEATHER ADVISORY SERVICE (HIWAS)	ATP-120
2-6-3.	PIREP INFORMATION	ATP-120
2-6-4.	WEATHER AND CHAFF SERVICES	ATP-120
2-6-5.	CALM WIND CONDITIONS	ATP-120
2-6-6.	REPORTING WEATHER CONDITIONS	ATP-120
2-6-7.	DISSEMINATING WEATHER INFORMATION	ATP-120

Section 7. Altimeter Settings

PARAGRAPH		OPI
2-7-1.	CURRENT SETTINGS	ATP-110
2-7-2.	ALTIMETER SETTING ISSUANCE BELOW LOWEST USABLE FL	ATP-110

Section 8. Runway Visibility Reporting- Terminal

PARAGRAPH		OPI
2-8-1.	FURNISH RVR/RVV VALUES	ATP-120
2-8-2.	ARRIVAL/DEPARTURE RUNWAY VISIBILITY	ATP-120
2-8-3.	TERMINOLOGY	ATP-120

Section 9. Automatic Terminal Information Service Procedures

PARAGRAPH		OPI
2-9-1.	APPLICATION	ATP-120
2-9-2.	OPERATING PROCEDURES	ATP-120
2-9-3.	CONTENT	ATP-120

Section 10. Team Position Responsibilities

PARAGRAPH		OPI
2-10-1.	EN ROUTE SECTOR TEAM POSITION RESPONSIBILITIES	ATP-110
2-10-2.	TERMINAL RADAR/NONRADAR TEAM POSITION RESPONSIBILITIES	ATP-120
2-10-3.	TOWER TEAM POSITION RESPONSIBILITIES	ATP-120

Chapter 3. Airport Traffic Control– Terminal

Section 1. General

PARAGRAPH		OPI
3-1-1.	PROVIDE SERVICE	ATP-120
3-1-2.	PREVENTIVE CONTROL	ATP-120
3-1-3.	USE OF ACTIVE RUNWAYS	ATP-120
3-1-4.	COORDINATION BETWEEN LOCAL AND GROUND CONTROLLERS	ATP-120
3-1-5.	VEHICLES/EQUIPMENT/PERSONNEL ON RUNWAYS	ATP-120
3-1-6.	TRAFFIC INFORMATION	ATP-120
3-1-7.	POSITION DETERMINATION	ATP-120
3-1-8.	LOW LEVEL WIND SHEAR/MICROBURST ADVISORIES	ATP-120
3-1-9.	USE OF TOWER RADAR DISPLAYS	ATP-120
3-1-10.	OBSERVED ABNORMALITIES	ATP-120
3-1-11.	SURFACE AREA RESTRICTIONS	ATP-120
3-1-12.	VISUALLY SCANNING RUNWAYS	ATP-120
3-1-13.	ESTABLISHING TWO-WAY COMMUNICATIONS	ATP-120
3-1-14.	GROUND OPERATIONS WHEN VOLCANIC ASH IS PRESENT	ATP-100

Section 2. Visual Signals

PARAGRAPH		OPI
3-2-1.	LIGHT SIGNALS	ATP-120
3-2-2.	WARNING SIGNAL	ATP-120
3-2-3.	RECEIVER-ONLY ACKNOWLEDGMENT	ATP-120

Section 3. Airport Conditions

PARAGRAPH		OPI
3-3-1.	LANDING AREA CONDITION	ATP-120
3-3-2.	CLOSED/UNSAFE RUNWAY INFORMATION	ATP-120
3-3-3.	TIMELY INFORMATION	ATP-120
3-3-4.	BRAKING ACTION	ATP-120
3-3-5.	BRAKING ACTION ADVISORIES	ATP-120
3-3-6.	ARRESTING SYSTEM OPERATION	ATP-120
3-3-7.	FAR FIELD MONITOR (FFM) REMOTE STATUS UNIT	ATP-120

Section 4. Airport Lighting

PARAGRAPH		OPI
3-4-1.	EMERGENCY LIGHTING	ATP-120
3-4-2.	RUNWAY END IDENTIFIER LIGHTS	ATP-120
3-4-3.	VISUAL APPROACH SLOPE INDICATORS (VASI)	ATP-120
3-4-4.	PRECISION APPROACH PATH INDICATORS (PAPI)	ATP-120
3-4-5.	APPROACH LIGHTS	ATP-120
3-4-6.	ALS INTENSITY SETTINGS	ATP-120
3-4-7.	SEQUENCED FLASHING LIGHTS (SFL)	ATP-120
3-4-8.	MALSR/ODALS	ATP-120
3-4-9.	ALSF-2/SSALR	ATP-120
3-4-10.	RUNWAY EDGE LIGHTS	ATP-120
3-4-11.	HIGH INTENSITY RUNWAY, RUNWAY CENTERLINE, AND TOUCHDOWN ZONE LIGHTS	ATP-120
3-4-12.	HIRL ASSOCIATED WITH MALSR	ATP-120
3-4-13.	HIRL CHANGES AFFECTING RVR	ATP-120
3-4-14.	MEDIUM INTENSITY RUNWAY LIGHTS	ATP-120
3-4-15.	SIMULTANEOUS APPROACH AND RUNWAY EDGE LIGHT OPERATION	ATP-120
3-4-16.	HIGH SPEED TURNOFF LIGHTS	ATP-120
3-4-17.	TAXIWAY LIGHTS	ATP-120
3-4-18.	OBSTRUCTION LIGHTS	ATP-120
3-4-19.	ROTATING BEACON	ATP-120

Section 5. Runway Selection

PARAGRAPH		OPI
3-5-1.	SELECTION	ATP-120
3-5-2.	STOL RUNWAYS	ATP-120
3-5-3.	TAILWIND COMPONENTS	ATP-120

Section 6. Airport Surface Detection Procedures

PARAGRAPH		OPI
3-6-1.	EQUIPMENT USAGE	ATP-120
3-6-2.	INFORMATION USAGE	ATP-120
3-6-3.	IDENTIFICATION	ATP-120
3-6-4.	AMASS ALERT RESPONSES	ATP-120

Section 7. Taxi and Ground Movement Procedures

PARAGRAPH		OPI
3-7-1.	GROUND TRAFFIC MOVEMENT	ATP-120
3-7-2.	TAXI AND GROUND MOVEMENT OPERATIONS	ATP-120
3-7-3.	GROUND OPERATIONS	ATP-120
3-7-4.	RUNWAY PROXIMITY	ATP-120
3-7-5.	PRECISION APPROACH CRITICAL AREA	ATP-120

Section 8. Spacing and Sequencing

PARAGRAPH		OPI
3-8-1.	SEQUENCE/SPACING APPLICATION	ATP-120
3-8-2.	TOUCH-AND-GO OR STOP-AND-GO OR LOW APPROACH	ATP-120
3-8-3.	SIMULTANEOUS SAME DIRECTION OPERATION	ATP-120
3-8-4.	SIMULTANEOUS OPPOSITE DIRECTION OPERATION	ATP-120

Section 9. Departure Procedures and Separation

PARAGRAPH		OPI
3-9-1.	DEPARTURE INFORMATION	ATP-120
3-9-2.	DEPARTURE DELAY INFORMATION	ATP-120
3-9-3.	DEPARTURE CONTROL INSTRUCTIONS	ATP-120
3-9-4.	TAXI INTO POSITION AND HOLD (TIPH)	ATP-120
3-9-5.	ANTICIPATING SEPARATION	ATP-120
3-9-6.	SAME RUNWAY SEPARATION	ATP-120
3-9-7.	WAKE TURBULENCE SEPARATION FOR INTERSECTION DEPARTURES	ATP-120
3-9-8.	INTERSECTING RUNWAY SEPARATION	ATP-120
3-9-9.	TAKEOFF CLEARANCE	ATP-120
3-9-10.	CANCELLATION OF TAKEOFF CLEARANCE	ATP-120

Section 10. Arrival Procedures and Separation

PARAGRAPH		OPI
3-10-1.	LANDING INFORMATION	ATP-120
3-10-2.	FORWARDING APPROACH INFORMATION BY NONAPPROACH CONTROL FACILITIES	ATP-120
3-10-3.	SAME RUNWAY SEPARATION	ATP-120
3-10-4.	INTERSECTING RUNWAY SEPARATION	ATP-120
3-10-5.	LANDING CLEARANCE	ATP-120
3-10-6.	ANTICIPATING SEPARATION	ATP-120
3-10-7.	LANDING CLEARANCE WITHOUT VISUAL OBSERVATION	ATP-120
3-10-8.	WITHHOLDING LANDING CLEARANCE	ATP-120
3-10-9.	RUNWAY EXITING	ATP-120
3-10-10.	ALTITUDE RESTRICTED LOW APPROACH	ATP-120

PARAGRAPH		OPI
3-10-11.	CLOSED TRAFFIC	ATP-120
3-10-12.	OVERHEAD MANEUVER	ATP-120
3-10-13.	SIMULATED FLAMEOUT (SFO) APPROACHES/EMERGENCY LANDING PATTERN (ELP) OPERATIONS/PRACTICE PRECAUTIONARY APPROACHES	ATP-120

Section 11. Helicopter Operations

PARAGRAPH		OPI
3-11-1.	TAXI AND GROUND MOVEMENT OPERATION	ATP-120
3-11-2.	HELICOPTER TAKEOFF CLEARANCE	ATP-120
3-11-3.	HELICOPTER DEPARTURE SEPARATION	ATP-120
3-11-4.	HELICOPTER ARRIVAL SEPARATION	ATP-120
3-11-5.	SIMULTANEOUS LANDINGS OR TAKEOFFS	ATP-120
3-11-6.	HELICOPTER LANDING CLEARANCE	ATP-120

Section 12. Sea Lane Operations

PARAGRAPH		OPI
3-12-1.	APPLICATION	ATP-120
3-12-2.	DEPARTURE SEPARATION	ATP-120
3-12-3.	ARRIVAL SEPARATION	ATP-120

Chapter 4. IFR

Section 1. NAVAID Use Limitations

PARAGRAPH		OPI
4-1-1.	ALTITUDE AND DISTANCE LIMITATIONS	ATP-100
4-1-2.	EXCEPTIONS	ATP-100
4-1-3.	CROSSING ALTITUDE	ATP-100
4-1-4.	VFR-ON-TOP	ATP-100
4-1-5.	FIX USE	ATP-100

Section 2. Clearances

PARAGRAPH		OPI
4-2-1.	CLEARANCE ITEMS	ATP-120
4-2-2.	CLEARANCE PREFIX	ATP-120
4-2-3.	DELIVERY INSTRUCTIONS	ATP-120
4-2-4.	CLEARANCE RELAY	ATP-100
4-2-5.	ROUTE OR ALTITUDE AMENDMENTS	ATP-100
4-2-6.	THROUGH CLEARANCES	ATP-100
4-2-7.	ALTRV CLEARANCE	ATP-200
4-2-8.	IFR-VFR AND VFR-IFR FLIGHTS	ATP-100
4-2-9.	CLEARANCE ITEMS	ATP-120

Section 3. Departure Procedures

PARAGRAPH		OPI
4-3-1.	DEPARTURE TERMINOLOGY	ATP-120
4-3-2.	DEPARTURE CLEARANCES	ATP-120
4-3-3.	ABBREVIATED DEPARTURE CLEARANCE	ATP-120
4-3-4.	DEPARTURE RESTRICTIONS, CLEARANCE VOID TIMES, HOLD FOR RELEASE, AND RELEASE TIMES	ATP-120 ATT-200
4-3-5.	GROUND STOP	ATT-200
4-3-6.	DELAY SEQUENCING	ATT-200
4-3-7.	FORWARD DEPARTURE DELAY INFORMATION	ATP-110
4-3-8.	COORDINATION WITH RECEIVING FACILITY	ATP-110
4-3-9.	VFR RELEASE OF IFR DEPARTURE	ATP-120
4-3-10.	FORWARDING DEPARTURE TIMES	ATP-120

Section 4. Route Assignment

PARAGRAPH		OPI
4-4-1.	ROUTE USE	ATP-100
4-4-2.	ROUTE STRUCTURE TRANSITIONS	ATP-100
4-4-3.	DEGREE-DISTANCE ROUTE DEFINITION FOR MILITARY OPERATIONS	ATP-200
4-4-4.	ALTERNATIVE ROUTES	ATP-110
4-4-5.	CLASS G AIRSPACE	ATP-100
4-4-6.	DIRECT CLEARANCES	ATT-200

Section 5. Altitude Assignment and Verification

PARAGRAPH		OPI
4-5-1.	VERTICAL SEPARATION MINIMA	ATP-100
4-5-2.	FLIGHT DIRECTION	ATA-400
4-5-3.	EXCEPTIONS	ATP-100
4-5-4.	LOWEST USABLE FLIGHT LEVEL	ATP-110
4-5-5.	ADJUSTED MINIMUM FLIGHT LEVEL	ATP-110
4-5-6.	MINIMUM EN ROUTE ALTITUDES	ATP-100
4-5-7.	ALTITUDE INFORMATION	ATP-100
4-5-8.	ANTICIPATED ALTITUDE CHANGES	ATP-100
4-5-9.	ALTITUDE CONFIRMATION-NONRADAR	ATP-100

Section 6. Holding Aircraft

PARAGRAPH		OPI
4-6-1.	CLEARANCE TO HOLDING FIX	ATP-100
4-6-2.	CLEARANCE BEYOND FIX	ATP-100
4-6-3.	DELAYS	ATT-200
4-6-4.	HOLDING INSTRUCTIONS	ATP-100
4-6-5.	VISUAL HOLDING POINTS	ATP-100
4-6-6.	HOLDING FLIGHT PATH DEVIATION	ATP-100
4-6-7.	UNMONITORED NAVAIDS	ATP-100
4-6-8.	ILS PROTECTION/CRITICAL AREAS	ATP-120

Section 7. Arrival Procedures

PARAGRAPH		OPI
4-7-1.	CLEARANCE INFORMATION	ATP-120
4-7-2.	ADVANCE DESCENT CLEARANCE	ATP-120
4-7-3.	SINGLE FREQUENCY APPROACHES (SFA)	ATP-200
4-7-4.	RADIO FREQUENCY AND RADAR BEACON CHANGES FOR MILITARY AIRCRAFT	ATP-200
4-7-5.	MILITARY TURBOJET EN ROUTE DESCENT	ATP-110
4-7-6.	ARRIVAL INFORMATION	ATP-120
4-7-7.	WEATHER INFORMATION	ATP-120
4-7-8.	BELOW MINIMA REPORT BY PILOT	ATP-120
4-7-9.	TRANSFER OF JURISDICTION	ATP-120
4-7-10.	APPROACH INFORMATION	ATP-120
4-7-11.	ARRIVAL INFORMATION BY APPROACH CONTROL FACILITIES	ATP-120
4-7-12.	AIRPORT CONDITIONS	ATP-120
4-7-13.	SWITCHING ILS/MLS RUNWAYS	ATP-120

Section 8. Approach Clearance Procedures

PARAGRAPH		OPI
4-8-1.	APPROACH CLEARANCE	ATP-120
4-8-2.	CLEARANCE LIMIT	ATP-120
4-8-3.	RELAYED APPROACH CLEARANCE	ATP-120
4-8-4.	ALTITUDE ASSIGNMENT FOR MILITARY HIGH ALTITUDE INSTRUMENT APPROACHES	ATP-200
4-8-5.	SPECIFYING ALTITUDE	ATP-120
4-8-6.	CIRCLING APPROACH	ATP-120
4-8-7.	SIDE-STEP MANEUVER	ATP-120
4-8-8.	COMMUNICATIONS RELEASE	ATP-120
4-8-9.	MISSED APPROACH	ATP-120
4-8-10.	APPROACH INFORMATION	ATP-120
4-8-11.	PRACTICE APPROACHES	ATP-120
4-8-12.	LOW APPROACH AND TOUCH-AND-GO	ATP-120

Chapter 5. Radar

Section 1. General

PARAGRAPH		OPI
5-1-1.	PRESENTATION AND EQUIPMENT PERFORMANCE	ATP-100
5-1-2.	ALIGNMENT ACCURACY CHECK	ATP-100
5-1-3.	RADAR USE	ATP-100
5-1-4.	BEACON RANGE ACCURACY	ATP-100
5-1-5.	ELECTRONIC ATTACK (EA) ACTIVITY	ATP-100
5-1-6.	SERVICE LIMITATIONS	ATP-100
5-1-7.	ELECTRONIC CURSOR	ATP-120
5-1-8.	MERGING TARGET PROCEDURES	ATP-100
5-1-9.	HOLDING PATTERN SURVEILLANCE	ATP-120
5-1-10.	DEVIATION ADVISORIES	ATP-120
5-1-11.	RADAR FIX POSTING	ATP-110
5-1-12.	POSITION REPORTING	ATP-100
5-1-13.	RADAR SERVICE TERMINATION	ATP-120

Section 2. Beacon Systems

PARAGRAPH		OPI
5-2-1.	ASSIGNMENT CRITERIA	ATP-100
5-2-2.	DISCRETE ENVIRONMENT	ATP-120
5-2-3.	NONDISCRETE ENVIRONMENT	ATP-120
5-2-4.	MIXED ENVIRONMENT	ATP-120
5-2-5.	RADAR BEACON CODE CHANGES	ATP-120
5-2-6.	FUNCTION CODE ASSIGNMENTS	ATP-110
5-2-7.	EMERGENCY CODE ASSIGNMENT	ATP-100
5-2-8.	RADIO FAILURE	ATP-100
5-2-9.	VFR CODE ASSIGNMENTS	ATP-100
5-2-10.	BEACON CODE FOR PRESSURE SUIT FLIGHTS AND FLIGHTS ABOVE FL 600	ATP-200
5-2-11.	AIR DEFENSE EXERCISE BEACON CODE ASSIGNMENT	ATP-200
5-2-12.	STANDBY OR LOW SENSITIVITY OPERATION	ATP-100
5-2-13.	CODE MONITOR	ATP-120
5-2-14.	FAILURE TO DISPLAY ASSIGNED BEACON CODE OR INOPERATIVE/MALFUNCTIONING TRANSPONDER	ATP-100
5-2-15.	INOPERATIVE OR MALFUNCTIONING INTERROGATOR	ATP-100
5-2-16.	FAILED TRANSPONDER IN CLASS A AIRSPACE	ATP-110
5-2-17.	VALIDATION OF MODE C READOUT	ATP-100
5-2-18.	ALTITUDE CONFIRMATION- MODE C	ATP-100
5-2-19.	ALTITUDE CONFIRMATION- NON-MODE C	ATP-100
5-2-20.	AUTOMATIC ALTITUDE REPORTING	ATP-100

PARAGRAPH		OPI
5-2-21.	INFLIGHT DEVIATIONS FROM TRANSPONDER/MODE C REQUIREMENTS BETWEEN 10,000 FEET AND 18,000 FEET	ATP-110
5-2-22.	BEACON TERMINATION	ATP-100
5-2-23.	ALTITUDE FILTERS	ATP-100

Section 3. Radar Identification

PARAGRAPH		OPI
5-3-1.	APPLICATION	ATP-100
5-3-2.	PRIMARY RADAR IDENTIFICATION METHODS	ATP-120
5-3-3.	BEACON IDENTIFICATION METHODS	ATP-100
5-3-4.	TERMINAL AUTOMATION SYSTEMS IDENTIFICATION METHODS	ATP-120
5-3-5.	QUESTIONABLE IDENTIFICATION	ATP-120
5-3-6.	POSITION INFORMATION	ATP-120
5-3-7.	IDENTIFICATION STATUS	ATP-120
5-3-8.	TARGET MARKERS	ATP-110
5-3-9.	TARGET MARKERS	ATP-110

Section 4. Transfer of Radar Identification

PARAGRAPH		OPI
5-4-1.	APPLICATION	ATP-100
5-4-2.	TERMS	ATP-100
5-4-3.	METHODS	ATP-100
5-4-4.	TRAFFIC	ATP-100
5-4-5.	TRANSFERRING CONTROLLER HANDOFF	ATP-100
5-4-6.	RECEIVING CONTROLLER HANDOFF	ATP-100
5-4-7.	POINT OUT	ATP-100
5-4-8.	AUTOMATED INFORMATION TRANSFER (AIT)	ATP-110
5-4-9.	INTERFACILITY AUTOMATED INFORMATION TRANSFER	ATP-110
5-4-10.	PREARRANGED COORDINATION	ATP-120
5-4-11.	EN ROUTE FOURTH LINE DATA BLOCK USAGE	ATO-E

Section 5. Radar Separation

PARAGRAPH		OPI
5-5-1.	APPLICATION	ATP-100
5-5-2.	TARGET SEPARATION	ATP-100
5-5-3.	TARGET RESOLUTION	ATP-120
5-5-4.	MINIMA	ATP-100
5-5-5.	VERTICAL APPLICATION	ATP-100
5-5-6.	EXCEPTIONS	ATP-100
5-5-7.	PASSING OR DIVERGING	ATP-120
5-5-8.	ADDITIONAL SEPARATION FOR FORMATION FLIGHTS	ATP-100

PARAGRAPH		OPI
5-5-9.	SEPARATION FROM OBSTRUCTIONS	ATP-100
5-5-10.	ADJACENT AIRSPACE	ATP-100
5-5-11.	EDGE OF SCOPE	ATP-100
5-5-12.	BEACON TARGET DISPLACEMENT	ATP-120
5-5-13.	GPA 102/103 CORRECTION FACTOR	ATP-120

Section 6. Vectoring

PARAGRAPH		OPI
5-6-1.	APPLICATION	ATP-100
5-6-2.	METHODS	ATP-100
5-6-3.	VECTORS BELOW MINIMUM ALTITUDE	ATP-100

Section 7. Speed Adjustment

PARAGRAPH		OPI
5-7-1.	APPLICATION	ATP-100
5-7-2.	METHODS	ATP-100
5-7-3.	MINIMA	ATP-100
5-7-4.	TERMINATION	ATP-100

Section 8. Radar Departures

PARAGRAPH		OPI
5-8-1.	PROCEDURES	ATP-120
5-8-2.	INITIAL HEADING	ATP-120
5-8-3.	SUCCESSIVE OR SIMULTANEOUS DEPARTURES	ATP-120
5-8-4.	DEPARTURE AND ARRIVAL	ATP-120
5-8-5.	DEPARTURES AND ARRIVALS ON PARALLEL OR NONINTERSECTING DIVERGING RUNWAYS	ATP-120

Section 9. Radar Arrivals

PARAGRAPH		OPI
5-9-1.	VECTORS TO FINAL APPROACH COURSE	ATP-120
5-9-2.	FINAL APPROACH COURSE INTERCEPTION	ATP-120
5-9-3.	VECTORS ACROSS FINAL APPROACH COURSE	ATP-120
5-9-4.	ARRIVAL INSTRUCTIONS	ATP-120
5-9-5.	APPROACH SEPARATION RESPONSIBILITY	ATP-120
5-9-6.	PARALLEL DEPENDENT ILS/MLS APPROACHES	ATP-120

PARAGRAPH		OPI
5-9-7.	SIMULTANEOUS INDEPENDENT ILS/MLS APPROACHES- DUAL & TRIPLE	ATP-120
5-9-8.	SIMULTANEOUS INDEPENDENT DUAL ILS/MLS APPROACHES- HIGH UPDATE RADAR	ATP-120

Section 10. Radar Approaches- Terminal

PARAGRAPH		OPI
5-10-1.	APPLICATION	ATP-120
5-10-2.	APPROACH INFORMATION	ATP-120
5-10-3.	NO-GYRO APPROACH	ATP-120
5-10-4.	LOST COMMUNICATIONS	ATP-120
5-10-5.	RADAR CONTACT LOST	ATP-120
5-10-6.	LANDING CHECK	ATP-120
5-10-7.	POSITION INFORMATION	ATP-120
5-10-8.	FINAL CONTROLLER CHANGEOVER	ATP-120
5-10-9.	COMMUNICATIONS CHECK	ATP-120
5-10-10.	TRANSMISSION ACKNOWLEDGMENT	ATP-120
5-10-11.	MISSED APPROACH	ATP-120
5-10-12.	LOW APPROACH AND TOUCH-AND-GO	ATP-120
5-10-13.	TOWER CLEARANCE	ATP-120
5-10-14.	FINAL APPROACH ABNORMALITIES	ATP-120
5-10-15.	MILITARY SINGLE FREQUENCY APPROACHES	ATP-200

Section 11. Surveillance Approaches- Terminal

PARAGRAPH		OPI
5-11-1.	ALTITUDE INFORMATION	ATP-120
5-11-2.	VISUAL REFERENCE REPORT	ATP-120
5-11-3.	DESCENT NOTIFICATION	ATP-120
5-11-4.	DESCENT INSTRUCTIONS	ATP-120
5-11-5.	FINAL APPROACH GUIDANCE	ATP-120
5-11-6.	APPROACH GUIDANCE TERMINATION	ATP-120

Section 12. PAR Approaches- Terminal

PARAGRAPH		OPI
5-12-1.	GLIDEPATH NOTIFICATION	ATP-120
5-12-2.	DECISION HEIGHT (DH) NOTIFICATION	ATP-120
5-12-3.	DESCENT INSTRUCTION	ATP-120
5-12-4.	GLIDEPATH AND COURSE INFORMATION	ATP-120
5-12-5.	DISTANCE FROM TOUCHDOWN	ATP-120
5-12-6.	DECISION HEIGHT	ATP-120
5-12-7.	POSITION ADVISORIES	ATP-120
5-12-8.	APPROACH GUIDANCE TERMINATION	ATP-120

PARAGRAPH		OPI
5-12-9.	COMMUNICATION TRANSFER	ATP-120
5-12-10.	ELEVATION FAILURE	ATP-120
5-12-11.	SURVEILLANCE UNUSABLE	ATP-120

Section 13. Use of PAR for Approach Monitoring- Terminal

PARAGRAPH		OPI
5-13-1.	MONITOR ON PAR EQUIPMENT	ATP-120
5-13-2.	MONITOR AVAILABILITY	ATP-120
5-13-3.	MONITOR INFORMATION	ATP-120

Section 14. Automation- En Route

PARAGRAPH		OPI
5-14-1.	CONFLICT ALERT (CA) AND MODE C INTRUDER (MCI) ALERT	ATP-110
5-14-2.	EN ROUTE MINIMUM SAFE ALTITUDE WARNING (E-MSAW)	ATP-110
5-14-3.	COMPUTER ENTRY OF ASSIGNED ALTITUDE	ATP-110
5-14-4.	ENTRY OF REPORTED ALTITUDE	ATP-110
5-14-5.	SELECTED ALTITUDE LIMITS	ATP-110
5-14-6.	SECTOR ELIGIBILITY	ATP-110
5-14-7.	COAST TRACKS	ATP-110
5-14-8.	CONTROLLER INITIATED COAST TRACKS	ATP-110

Section 15. Automated Radar Terminal Systems (ARTS)- Terminal

PARAGRAPH		OPI
5-15-1.	APPLICATION	ATP-120
5-15-2.	RESPONSIBILITY	ATP-120
5-15-3.	FUNCTIONAL USE	ATP-120
5-15-4.	SYSTEM REQUIREMENTS	ATP-120
5-15-5.	INFORMATION DISPLAYED	ATP-120
5-15-6.	CA/MCI	ATP-120
5-15-7.	INHIBITING MINIMUM SAFE ALTITUDE WARNING (MSAW)	ATP-120
5-15-8.	TRACK SUSPEND FUNCTION	ATP-120

Section 16. TPX-42- Terminal

PARAGRAPH		OPI
5-16-1.	APPLICATION	ATP-120
5-16-2.	RESPONSIBILITY	ATP-120
5-16-3.	FUNCTIONAL USE	ATP-120
5-16-4.	SYSTEM REQUIREMENTS	ATP-120

PARAGRAPH		OPI
5-16-5.	INFORMATION DISPLAYED	ATP-120
5-16-6.	INHIBITING LOW ALTITUDE ALERT SYSTEM (LAAS)	ATP-120

Chapter 6. Nonradar Section 1. General

PARAGRAPH		OPI
6-1-1.	DISTANCE	ATP-100
6-1-2.	NONRECEIPT OF POSITION REPORT	ATP-100
6-1-3.	DUPLICATE POSITION REPORTS	ATP-100
6-1-4.	ADJACENT AIRPORT OPERATION	ATP-120
6-1-5.	ARRIVAL MINIMA	ATP-120

Section 2. Initial Separation of Successive Departing Aircraft

PARAGRAPH		OPI
6-2-1.	MINIMA ON DIVERGING COURSES	ATP-120
6-2-2.	MINIMA ON SAME COURSE	ATP-100

Section 3. Initial Separation of Departing and Arriving Aircraft

PARAGRAPH		OPI
6-3-1.	SEPARATION MINIMA	ATP-120

Section 4. Longitudinal Separation

PARAGRAPH		OPI
6-4-1.	APPLICATION	ATP-100
6-4-2.	MINIMA ON SAME, CONVERGING, OR CROSSING COURSES	ATP-100
6-4-3.	MINIMA ON OPPOSITE COURSES	ATP-100
6-4-4.	SEPARATION BY PILOTS	ATP-100
6-4-5.	RNAV AIRCRAFT ALONG VOR AIRWAYS/ROUTES	ATP-100

Section 5. Lateral Separation

PARAGRAPH		OPI
6-5-1.	SEPARATION METHODS	ATP-100
6-5-2.	MINIMA ON DIVERGING RADIALS	ATP-100
6-5-3.	DME ARC MINIMA	ATP-100
6-5-4.	MINIMA ALONG OTHER THAN ESTABLISHED AIRWAYS OR ROUTES	ATP-100
6-5-5.	RNAV MINIMA- DIVERGING/CROSSING COURSES	ATP-100

Section 6. Vertical Separation

PARAGRAPH		OPI
6-6-1.	APPLICATION	ATP-100
6-6-2.	EXCEPTIONS	ATP-100
6-6-3.	SEPARATION BY PILOTS	ATP-100

Section 7. Timed Approaches

PARAGRAPH		OPI
6-7-1.	APPLICATION	ATP-120
6-7-2.	APPROACH SEQUENCE	ATP-120
6-7-3.	SEQUENCE INTERRUPTION	ATP-120
6-7-4.	LEVEL FLIGHT RESTRICTION	ATP-120
6-7-5.	INTERVAL MINIMA	ATP-120
6-7-6.	TIME CHECK	ATP-120
6-7-7.	MISSED APPROACHES	ATP-120

Chapter 7. Visual

Section 1. General

PARAGRAPH		OPI
7-1-1.	CLASS A AIRSPACE RESTRICTIONS	ATP-110
7-1-2.	VFR CONDITIONS	ATP-100
7-1-3.	APPROACH CONTROL SERVICE FOR VFR ARRIVING AIRCRAFT	ATP-120
7-1-4.	VISUAL HOLDING OF VFR AIRCRAFT	ATP-120

Section 2. Visual Separation

PARAGRAPH		OPI
7-2-1.	VISUAL SEPARATION	ATP-100

Section 3. VFR-on-Top

PARAGRAPH		OPI
7-3-1.	VFR-ON-TOP	ATP-100
7-3-2.	ALTITUDE FOR DIRECTION OF FLIGHT	ATP-100 ATA-400

Section 4. Approaches

PARAGRAPH		OPI
7-4-1.	VISUAL APPROACH	ATP-120
7-4-2.	VECTORS FOR VISUAL APPROACH	ATP-120
7-4-3.	CLEARANCE FOR VISUAL APPROACH	ATP-120
7-4-4.	APPROACHES TO MULTIPLE RUNWAYS	ATP-120

PARAGRAPH		OPI
7-4-5.	CHARTED VISUAL FLIGHT PROCEDURES (CVFP). USA/USN NOT APPLICABLE	ATP-120
7-4-6.	CONTACT APPROACH	ATP-120

Section 5. Special VFR (SVFR)

PARAGRAPH		OPI
7-5-1.	AUTHORIZATION	ATP-120
7-5-2.	PRIORITY	ATP-120
7-5-3.	SEPARATION	ATP-120
7-5-4.	ALTITUDE ASSIGNMENT	ATP-120
7-5-5.	LOCAL OPERATIONS	ATP-120
7-5-6.	CLIMB TO VFR	ATP-120
7-5-7.	GROUND VISIBILITY BELOW ONE MILE	ATP-120
7-5-8.	FLIGHT VISIBILITY BELOW ONE MILE	ATP-120

Section 6. Basic Radar Service to VFR Aircraft- Terminal

PARAGRAPH		OPI
7-6-1.	APPLICATION	ATP-120
7-6-2.	SERVICE AVAILABILITY	ATP-120
7-6-3.	INITIAL CONTACT	ATP-120
7-6-4.	IDENTIFICATION	ATP-120
7-6-5.	HOLDING	ATP-120
7-6-6.	APPROACH SEQUENCE	ATP-120
7-6-7.	SEQUENCING	ATP-120
7-6-8.	CONTROL TRANSFER	ATP-120
7-6-9.	ABANDONED APPROACH	ATP-120
7-6-10.	VFR DEPARTURE INFORMATION	ATP-120
7-6-11.	TERMINATION OF SERVICE	ATP-120
7-6-12.	SERVICE PROVIDED WHEN TOWER IS INOPERATIVE	ATP-120

Section 7. Terminal Radar Service Area (TRSA)- Terminal

PARAGRAPH		OPI
7-7-1.	APPLICATION	ATP-120
7-7-2.	ISSUANCE OF EFC	ATP-120
7-7-3.	SEPARATION	ATP-120
7-7-4.	HELICOPTER TRAFFIC	ATP-120
7-7-5.	ALTITUDE ASSIGNMENTS	ATP-120
7-7-6.	APPROACH INTERVAL	ATP-120
7-7-7.	TRSA DEPARTURE INFORMATION	ATP-120

Section 8. Class C Service– Terminal

PARAGRAPH		OPI
7-8-1.	APPLICATION	ATP-120
7-8-2.	CLASS C SERVICES	ATP-120
7-8-3.	SEPARATION	ATP-120
7-8-4.	ESTABLISHING TWO-WAY COMMUNICATIONS	ATP-120
7-8-5.	ALTITUDE ASSIGNMENTS	ATP-120
7-8-6.	EXCEPTIONS	ATP-120
7-8-7.	ADJACENT AIRPORT OPERATIONS	ATP-120
7-8-8.	TERMINATION OF SERVICE	ATP-120

Section 9. Class B Service Area– Terminal

PARAGRAPH		OPI
7-9-1.	APPLICATION	ATP-120
7-9-2.	VFR AIRCRAFT IN CLASS B AIRSPACE	ATP-120
7-9-3.	METHODS	ATP-120
7-9-4.	SEPARATION	ATP-120
7-9-5.	TRAFFIC ADVISORIES	ATP-120
7-9-6.	HELICOPTER TRAFFIC	ATP-120
7-9-7.	ALTITUDE ASSIGNMENTS	ATP-120
7-9-8.	APPROACH INTERVAL	ATP-120

Chapter 8. Offshore/Oceanic Procedures

Section 1. General

PARAGRAPH		OPI
8-1-1.	ATC SERVICE	ATP-130
8-1-2.	OPERATIONS IN OFFSHORE AIRSPACE AREAS	ATP-130
8-1-3.	VFR FLIGHT PLANS	ATP-130
8-1-4.	TYPES OF SEPARATION	ATP-130
8-1-5.	ALTIMETER SETTING	ATP-130
8-1-6.	RECEIPT OF POSITION REPORTS	ATP-130
8-1-7.	OCEANIC NAVIGATIONAL ERROR REPORTING (ONER) PROCEDURES	ATP-130
8-1-8.	USE OF CONTROL ESTIMATES	ATP-130

Section 2. Coordination

PARAGRAPH		OPI
8-2-1.	GENERAL	ATP-130
8-2-2.	TRANSFER OF CONTROL AND COMMUNICATIONS	ATP-130
8-2-3.	AIR TRAFFIC SERVICES INTERFACILITY DATA COMMUNICATIONS (AIDC)	ATP-130

Section 3. Longitudinal Separation

PARAGRAPH		OPI
8-3-1.	APPLICATION	ATP-130
8-3-2.	SEPARATION METHODS	ATP-130
8-3-3.	MACH NUMBER TECHNIQUE	ATP-130

Section 4. Lateral Separation

PARAGRAPH		OPI
8-4-1.	APPLICATION	ATP-130
8-4-2.	SEPARATION METHODS	ATP-130
8-4-3.	REDUCTION OF ROUTE PROTECTED AIRSPACE	ATP-130
8-4-4.	TRACK SEPARATION	ATP-130

Section 5. Offshore/Oceanic Transition Procedures

PARAGRAPH		OPI
8-5-1.	ALTITUDE/FLIGHT LEVEL TRANSITION	ATP-130
8-5-2.	COURSE DIVERGENCE	ATP-130
8-5-3.	OPPOSITE DIRECTION	ATP-130
8-5-4.	SAME DIRECTION	ATP-130

Section 6. Separation from Airspace Reservations

PARAGRAPH		OPI
8-6-1.	TEMPORARY STATIONARY AIRSPACE RESERVATIONS	ATP-130
8-6-2.	REFUSAL OF AVOIDANCE CLEARANCE	ATP-130
8-6-3.	TEMPORARY MOVING AIRSPACE RESERVATIONS	ATP-130

Section 7. North Atlantic ICAO Region

PARAGRAPH		OPI
8-7-1.	APPLICATION	ATP-130
8-7-2.	VERTICAL SEPARATION	ATP-130
8-7-3.	LONGITUDINAL SEPARATION	ATP-130
8-7-4.	LATERAL SEPARATION	ATP-130
8-7-5.	PROCEDURES FOR WEATHER DEVIATIONS IN NORTH ATLANTIC (NAT) AIRSPACE	ATP-130

Section 8. Caribbean ICAO Region

PARAGRAPH		OPI
8-8-1.	APPLICATION	ATP-130
8-8-2.	VERTICAL SEPARATION	ATP-130
8-8-3.	LONGITUDINAL SEPARATION	ATP-130

PARAGRAPH		OPI
8-8-4.	LATERAL SEPARATION	ATP-130
8-8-5.	VFR CLIMB AND DESCENT	ATP-130

Section 9. Pacific ICAO Region

PARAGRAPH		OPI
8-9-1.	APPLICATION	ATP-130
8-9-2.	VERTICAL SEPARATION	ATP-130
8-9-3.	LONGITUDINAL SEPARATION	ATP-130
8-9-4.	LATERAL SEPARATION	ATP-130
8-9-5.	COMPOSITE SEPARATION MINIMA	ATP-130
8-9-6.	COMPOSITE SEPARATION ALTITUDE ASSIGNMENT	ATP-130
8-9-7.	COMPOSITE SEPARATION APPLICATION	ATP-130
8-9-8.	PROCEDURES FOR WEATHER DEVIATIONS AND OTHER CONTINGENCIES IN OCEANIC CONTROLLED AIRSPACE	ATP-130

Section 10. North American ICAO Region- Arctic CTA

PARAGRAPH		OPI
8-10-1.	APPLICATION	ATP-130
8-10-2.	VERTICAL SEPARATION	ATP-130
8-10-3.	LONGITUDINAL SEPARATION	ATP-130
8-10-4.	LATERAL SEPARATION	ATP-130

**Chapter 9. Special Flights
Section 1. General**

PARAGRAPH		OPI
9-1-1.	GENERAL	ATP-100
9-1-2.	SPECIAL HANDLING	ATP-100
9-1-3.	FLIGHT CHECK AIRCRAFT	ATP-100

Section 2. Special Interest Flights

PARAGRAPH		OPI
9-2-1.	GENERAL	ATT-200
9-2-2.	APPLICATION	ATT-200
9-2-3.	EMERGENCY OR UNSCHEDULED LANDINGS	ATT-200

Section 3. Special Operations

PARAGRAPH		OPI
9-3-1.	AIRCRAFT CARRYING DANGEROUS MATERIALS	ATP-200
9-3-2.	CELESTIAL NAVIGATION TRAINING	ATP-200

PARAGRAPH		OPI
9-3-3.	DEPARTMENT OF ENERGY (DOE) SPECIAL FLIGHTS	ATP-100
9-3-4.	EXPERIMENTAL AIRCRAFT OPERATIONS	ATP-120
9-3-5.	FAA RESEARCH AND DEVELOPMENT FLIGHTS	ATP-100
9-3-6.	FLYNET	ATP-200
9-3-7.	IFR MILITARY TRAINING ROUTES	ATP-100
9-3-8.	INTERCEPTOR OPERATIONS	ATP-200
9-3-9.	SPECIAL INTEREST SITES	ATP-120
9-3-10.	LAND-BASED AIR DEFENSE IDENTIFICATION ZONE (ADIZ) ATC PROCEDURES	ATP-120
9-3-11.	LAW ENFORCEMENT OPERATIONS BY CIVIL AND MILITARY ORGANIZATIONS	ATP-200
9-3-12.	MILITARY AERIAL REFUELING	ATP-200
9-3-13.	MILITARY OPERATIONS ABOVE FL 600	ATP-200
9-3-14.	MILITARY SPECIAL USE FREQUENCIES	ATP-200
9-3-15.	AVOIDANCE OF AREAS OF NUCLEAR RADIATION	ATP-200
9-3-16.	SAMP	ATP-200
9-3-17.	AWACS/NORAD SPECIAL FLIGHTS	ATP-200
9-3-18.	WEATHER RECONNAISSANCE FLIGHTS	ATT-200
9-3-19.	EVASIVE ACTION MANEUVER	ATP-110
9-3-20.	NONSTANDARD FORMATION/CELL OPERATIONS	ATP-100
9-3-21.	OPEN SKIES TREATY AIRCRAFT	ATP-200

Section 4. Special Use and ATC Assigned Airspace

PARAGRAPH		OPI
9-4-1.	APPLICATION	ATP-200
9-4-2.	SEPARATION MINIMA	ATP-200
9-4-3.	VFR-ON-TOP	ATP-200
9-4-4.	TRANSITING ACTIVE SUA/ATCAA	ATP-200

Section 5. Fuel Dumping

PARAGRAPH		OPI
9-5-1.	INFORMATION REQUIREMENTS	ATP-100
9-5-2.	ROUTING	ATP-100
9-5-3.	ALTITUDE ASSIGNMENT	ATP-100
9-5-4.	SEPARATION MINIMA	ATP-100
9-5-5.	INFORMATION DISSEMINATION	ATP-100

Section 6. Jettisoning of External Stores

PARAGRAPH		OPI
9-6-1.	JETTISONING OF EXTERNAL STORES	ATP-200

Section 7. Unmanned Free Balloons

PARAGRAPH		OPI
9-7-1.	APPLICATION	ATA-400
9-7-2.	DERELICT BALLOONS	ATA-400

Section 8. Parachute Operations

PARAGRAPH		OPI
9-8-1.	COORDINATION	ATA-400
9-8-2.	CLASS A, CLASS B, AND CLASS C AIRSPACE	ATA-400
9-8-3.	CLASS D AIRSPACE	ATA-400
9-8-4.	OTHER CONTROL AIRSPACE	ATA-400

Section 9. Unidentified Flying Object (UFO) Reports

PARAGRAPH		OPI
9-9-1.	GENERAL	ATP-200

Chapter 10. Emergencies

Section 1. General

PARAGRAPH		OPI
10-1-1.	EMERGENCY DETERMINATIONS	ATP-100
10-1-2.	OBTAINING INFORMATION	ATP-100
10-1-3.	PROVIDING ASSISTANCE	ATP-100
10-1-4.	RESPONSIBILITY	ATP-100
10-1-5.	COORDINATION	ATP-100
10-1-6.	AIRPORT GROUND EMERGENCY	ATP-120
10-1-7.	INFLIGHT EMERGENCIES INVOLVING MILITARY FIGHTER-TYPE AIRCRAFT	ATP-200

Section 2. Emergency Assistance

PARAGRAPH		OPI
10-2-1.	INFORMATION REQUIREMENTS	ATP-100
10-2-2.	FREQUENCY CHANGES	ATP-100
10-2-3.	AIRCRAFT ORIENTATION	ATP-100
10-2-4.	ALTITUDE CHANGE FOR IMPROVED RECEPTION	ATP-100
10-2-5.	EMERGENCY SITUATIONS	ATP-100
10-2-6.	HIJACKED AIRCRAFT	ATP-100
10-2-7.	VFR AIRCRAFT IN WEATHER DIFFICULTY	ATP-100
10-2-8.	RADAR ASSISTANCE TO VFR AIRCRAFT IN WEATHER DIFFICULTY	ATP-100
10-2-9.	RADAR ASSISTANCE TECHNIQUES	ATP-100
10-2-10.	EMERGENCY LOCATOR TRANSMITTER (ELT) SIGNALS	ATP-100
10-2-11.	AIRCRAFT BOMB THREATS	ATP-100
10-2-12.	EXPLOSIVE DETECTION K-9 TEAMS	ATP-100

PARAGRAPH		OPI
10-2-13.	MANPADS ALERT	ATP-120
10-2-14.	EMERGENCY AIRPORT RECOMMENDATION	ATP-100
10-2-15.	GUIDANCE TO EMERGENCY AIRPORT	ATP-100
10-2-16.	EMERGENCY OBSTRUCTION VIDEO MAP (EOVM)	ATP-100
10-2-17.	VOLCANIC ASH	ATP-100

Section 3. Overdue Aircraft

PARAGRAPH		OPI
10-3-1.	OVERDUE AIRCRAFT	ATP-100
10-3-2.	INFORMATION TO BE FORWARDED TO ARTCC	ATP-120
10-3-3.	INFORMATION TO BE FORWARDED TO RCC	ATP-110
10-3-4.	ALNOT	ATP-110
10-3-5.	RESPONSIBILITY TRANSFER TO RCC	ATP-100
10-3-6.	AIRCRAFT POSITION PLOTS	ATP-100
10-3-7.	ALNOT CANCELLATION	ATP-110

Section 4. Control Actions

PARAGRAPH		OPI
10-4-1.	TRAFFIC RESTRICTIONS	ATP-100
10-4-2.	LIGHTING REQUIREMENTS	ATP-100
10-4-3.	TRAFFIC RESUMPTION	ATP-100
10-4-4.	COMMUNICATIONS FAILURE	ATP-100

Section 5. Miscellaneous Operations

PARAGRAPH		OPI
10-5-1.	NAVY FLEET SUPPORT MISSIONS	ATP-200
10-5-2.	EXPLOSIVE CARGO	ATP-200

Section 6. Oceanic Emergency Procedures

PARAGRAPH		OPI
10-6-1.	APPLICATION	ATP-130
10-6-2.	PHASES OF EMERGENCY	ATP-130
10-6-3.	ALERTING SERVICE AND SPECIAL ASSISTANCE	ATP-130
10-6-4.	INFLIGHT CONTINGENCIES	ATP-130
10-6-5.	SERVICES TO RESCUE AIRCRAFT	ATP-130

Section 7. Ground Missile Emergencies

PARAGRAPH		OPI
10-7-1.	INFORMATION RELAY	ATP-200
10-7-2.	IFR AND SPECIAL VFR MINIMA	ATP-200
10-7-3.	VFR MINIMA	ATP-200
10-7-4.	SMOKE COLUMN AVOIDANCE	ATP-200
10-7-5.	EXTENDED NOTIFICATION	ATP-200

**Chapter 11. Traffic Management
Procedures**

Section 1. General

PARAGRAPH		OPI
11-1-1.	DUTY RESPONSIBILITY	ATT-200
11-1-2.	DUTIES AND RESPONSIBILITIES	ATT-200

**Chapter 12. Canadian Airspace
Procedures**

Section 1. General Control

PARAGRAPH		OPI
12-1-1.	APPLICATION	ATP-100
12-1-2.	AIRSPACE CLASSIFICATION	ATP-100
12-1-3.	ONE THOUSAND-ON-TOP	ATP-100
12-1-4.	SEPARATION	ATP-100
12-1-5.	DEPARTURE CLEARANCE/ COMMUNICATION FAILURE	ATP-100
12-1-6.	PARACHUTE JUMPING	ATP-100
12-1-7.	SPECIAL VFR (SVFR)	ATP-100

Chapter 13. Decision Support Tools

**Section 1. User Request Evaluation Tool (URET) –
En Route**

PARAGRAPH		OPI
13-1-1.	DESCRIPTION	ATP-110
13-1-2.	CONFLICT DETECTION AND RESOLUTION	ATP-110
13-1-3.	TRIAL PLANNING	ATP-110

PARAGRAPH		OPI
13-1-4.	URET-BASED CLEARANCES	ATP-110
13-1-5.	THE AIRCRAFT LIST (ACL) AND FLIGHT DATA MANAGEMENT	ATP-110
13-1-6.	RECORDING OF CONTROL DATA	ATP-110
13-1-7.	ACKNOWLEDGEMENT OF AUTOMATED NOTIFICATION	ATP-110
13-1-8.	CURRENCY OF TRAJECTORY INFORMATION	ATP-110
13-1-9.	DELAY REPORTING	ATP-110
13-1-10.	OVERDUE AIRCRAFT	ATP-110
13-1-11.	USE OF GRAPHICS PLAN DISPLAY (GPD)	ATP-110
13-1-12.	FORECAST WINDS	ATP-110
13-1-13.	INTERFACILITY CONNECTIVITY	ATP-110
13-1-14.	PRIMARY RDP/FDP OUTAGES	ATP-110

Section 2. Ocean21 – Oceanic

PARAGRAPH		OPI
13-2-1.	DESCRIPTION	ATP-130
13-2-2.	CONFLICT DETECTION AND RESOLUTION	ATP-130
13-2-3.	INFORMATION MANAGEMENT	ATP-130
13-2-4.	CONTROLLER PILOT DATA LINK COMMUNICATIONS (CPDLC)	ATP-130
13-2-5.	COORDINATION	ATP-130
13-2-6.	TEAM RESPONSIBILITIES – MULTIPLE PERSON OPERATION	ATP-130

Appendices

APPENDIX	OPI
APPENDIX A. AIRCRAFT INFORMATION	ATP-120
APPENDIX B. AIRCRAFT INFORMATION HELICOPTER/ROTORCRAFTS	ATP-120
APPENDIX C. AIRCRAFT INFORMATION SPECIFIC HOMEBUILT/EXPERIMENTAL AIRCRAFT	ATP-120
APPENDIX D. STANDARD OPERATING PRACTICE (SOP) FOR THE TRANSFER OF POSITION RESPONSIBILITY	ATP-100

Pilot/Controller Glossary

PILOT/CONTROLLER GLOSSARY	ATP-100
---------------------------	---------



U.S. Department
of Transportation
**Federal Aviation
Administration**

7110.65P CHG 3
8/4/05

BRIEFING GUIDE



U.S. DEPARTMENT OF TRANSPORTATION
FEDERAL AVIATION ADMINISTRATION

Initiated By: ATO-R

Table of Contents

Paragraph Number	Title	Page
1-2-6	ABBREVIATIONS	3
2-1-6	SAFETY ALERT	8
2-1-7	INFLIGHT EQUIPMENT MALFUNCTIONS	9
2-1-13	FORMATION FLIGHTS	9
2-1-28	RVSM OPERATIONS	9
2-2-2	FORWARDING INFORMATION	3
2-2-6	IFR FLIGHT PROGRESS DATA	3
2-2-9	COMPUTER MESSAGE VERIFICATION	3
2-2-11	FORWARDING AMENDED AND UTM DATA	3
2-3-7	AIRCRAFT EQUIPMENT SUFFIX	13
4-4-6	DIRECT CLEARANCES	15
4-5-1	VERTICAL SEPARATION MINIMA	15
4-5-2	FLIGHT DIRECTION	16
4-5-3	EXCEPTIONS	18
5-1-2	ALIGNMENT ACCURACY CHECK	3
5-1-6	SERVICE LIMITATIONS	3
5-1-8	MERGING TARGET PROCEDURES	9
5-1-11	RADAR FIX POSTING	3
5-4-3	METHODS	3
5-5-7	PASSING OR DIVERGING	18
5-5-8	ADDITIONAL SEPARATION FOR FORMATION FLIGHTS	9
5-14-2	EN ROUTE MINIMUM SAFE ALTITUDE WARNING (E-MSAW)	19
5-14-3	COMPUTER ENTRY OF ASSIGNED ALTITUDE	3
5-14-5	SELECTED ALTITUDE LIMITS	3
9-5-4	SEPARATION MINIMA	20
13-1-14	HOST OUTAGES	3
APPENDIX A	AIRCRAFT INFORMATION	20

- 1. PARAGRAPH NUMBER AND TITLE:** 1-2-6. ABBREVIATIONS
- 2-2-2. FORWARDING INFORMATION
- 2-2-6. IFR FLIGHT PROGRESS DATA
- 2-2-9. COMPUTER MESSAGE VERIFICATION
- 2-2-11. FORWARDING AMENDED AND UTM DATA
- 5-1-2. ALIGNMENT ACCURACY CHECK
- 5-1-6. SERVICE LIMITATIONS
- 5-1-11. RADAR FIX POSTING
- 5-4-3. METHODS
- 5-14-3. COMPUTER ENTRY OF ASSIGNED ALTITUDE
- 5-14-5. SELECTED ALTITUDE LIMITS
- 13-1-14. HOST OUTAGES

2. BACKGROUND: The En Route Automation System (EAS) evolved over the years from broadband radar and a separate mainframe computer-based flight data processor to a complex integrated environment consisting of display systems, digitized radar data processing, remote devices, decision support tools, etc. This order reflects parts of this evolution by referring to the EAS and/or various components by various names. References are made to NAS, NAS Stage A, Stage A, Narrowband, Host, EDARC, DARC, and PVD/MDM for example. The current en route backup radar data processor, DARC, is being replaced by a system based on MEARTS software. However, this new DARC system will not always function the same as the MEARTS currently referenced in this order. References to equipment were reviewed in light of the new system and where possible changes were made so that references to equipment are more consistent throughout the order.

3. CHANGE:

OLD
TBL 1-2-1
FAA Order 7110.65 Abbreviations

Abbreviation	Meaning
Add	Add
<u>EDARC</u>	<u>Enhanced Direct Access Radar Channel</u>

NEW
TBL 1-2-1
FAA Order 7110.65 Abbreviations

Abbreviation	Meaning
<u>EAS</u>	<u>En Route Automation System</u>
Delete	Delete

OLD

2-2-2. FORWARDING INFORMATION

- a. Except during NAS Stage A operation, forward the flight plan information to the appropriate ATC facility, FSS, or BASOPS and record the time of filing and delivery on the form.
- b. *EN ROUTE.* During NAS Stage A operation, the above manual actions are required in cases where the data is not forwarded automatically by the computer.

NOTE-
During NAS Stage A operation, data is exchanged between interfaced automated facilities and both the data and time of transmission are recorded automatically.

NEW

2-2-2. FORWARDING INFORMATION

- a. Except during EAS FDP operation, forward the flight plan information to the appropriate ATC facility, FSS, or BASOPS and record the time of filing and delivery on the form.
- b. *EN ROUTE.* During EAS FDP operation, the above manual actions are required in cases where the data is not forwarded automatically by the computer.

NOTE-
During EAS FDP operation, data is exchanged between interfaced automated facilities and both the data and time of transmission are recorded automatically.

OLD**2-2-6. IFR FLIGHT PROGRESS DATA****Title through a**~~10~~**REFERENCE**

11. When flight plan data must be forwarded manually and an aircraft has been assigned a beacon code by the computer, include the code as part of the flight plan.

NOTE-

When an IFR aircraft, or a VFR aircraft that has been assigned a beacon code by the host computer and whose flight plan will terminate in another facility's area cancels ATC service or does not activate the flight plan, send a remove strips (RS) message on that aircraft via the host keyboard, the FDIO keyboard or call via service F.

NEW**2-2-6. IFR FLIGHT PROGRESS DATA**

No Change

No Change

NOTE-

When an IFR aircraft, or a VFR aircraft that has been assigned a beacon code by the EAS and whose flight plan will terminate in another facility's area, cancels ATC service or does not activate the flight plan, send a remove strips (RS) message on that aircraft via the EAS keyboard, the FDIO keyboard or call via service F.

OLD**2-2-9. COMPUTER MESSAGE VERIFICATION****Title through a**3

b. Any cancellation of IFR or HOST generated VFR flight plan.

NEW**2-2-9. COMPUTER MESSAGE VERIFICATION**

No Change

b. Any cancellation of IFR or EAS generated VFR flight plan.

OLD**2-2-11. FORWARDING AMENDED AND UTM DATA****Title through a**~~REFERENCE~~

b. Computer acceptance of an appropriate input message fulfills the requirement for sending amended data. During NAS Stage A operations, the amendment data are considered acknowledged on receipt of a Computer Readout Device (CRD) update message or a computer-generated flight progress strip containing the amended data.

NEW**2-2-11. FORWARDING AMENDED AND UTM DATA**

No Change

b. Computer acceptance of an appropriate input message fulfills the requirement for sending amended data. During EAS FDP operations, the amendment data are considered acknowledged on receipt of a computer update message or a computer-generated flight progress strip containing the amended data.

OLD**5-1-2. ALIGNMENT ACCURACY CHECK****Title through c***EN ROUTE*

d. When operating in the narrowband mode (Stage A) alignment checking is accomplished by the operational program as part of the certification procedures for system startup and then on a real-time basis during operational hours.

NEW**5-1-2. ALIGNMENT ACCURACY CHECK**

No Change

EN ROUTE

d. Radar Data Processing (RDP) alignment checking is accomplished by the operational program as part of the certification procedures for system startup and then on a real-time basis during operational hours.

e. When operating in the EDARC/DARC/HOST or EDARC/DARC mode, ensure the PVD/MDM center and altitude limits for the system are appropriate for the operating position.

e. Ensure the **situation display** center and altitude limits for the system are appropriate for the operating position.

REFERENCE-
FAAO 7110.65, *Selected Altitude Limits, Para 5-14-5.*

No Change

OLD

5-1-6. SERVICE LIMITATIONS

Title through a3

b. **EN ROUTE. Stage A and DARC-** When the position symbol associated with the full data block falls more than one history behind the actual aircraft target or there is no target symbol displayed, the Mode C information in the full data block shall not be used for the purpose of determining separation.

NEW

5-1-6. SERVICE LIMITATIONS

No Change

b. **EN ROUTE.** When the position symbol associated with the full data block falls more than one history behind the actual aircraft target or there is no target symbol displayed, the Mode C information in the full data block shall not be used for the purpose of determining separation.

OLD

5-1-11. RADAR FIX POSTING

EN ROUTE

A controller is required to manually record at least once the observed or reported time over a fix for each controlled aircraft in their sector of responsibility only when the flight progress recording components of the **HOST/DARC or the EARTS systems** are not operational.

NEW

5-1-11. RADAR FIX POSTING

No Change

A controller is required to manually record at least once the observed or reported time over a fix for each controlled aircraft in their sector of responsibility only when the flight progress recording components of the **EAS FDP** are not operational.

REFERENCE-
FAAO 7210.3, *Flight Progress Strip Usage, Para 6-1-6.*
FAAO 7210.3, *Flight Progress Strip Usage, Para 10-1-8.*

No Change

OLD

5-4-3. METHODS

a. Transfer the radar identification of an aircraft by at least one of the following methods:

1. Physically point to the target on the receiving controller's display.
2. Use landline voice communications.
3. Use automation capabilities.

Add

NEW

5-4-3. METHODS

No Change

No Change

No Change

No Change

NOTE-
EN ROUTE. Interfacility handoff capabilities are available that can be manually initiated and accepted when operating on the backup RDP while FDP is available. The backup RDP by itself does not have the capabilities for interfacility handoffs. Therefore, handoffs between facilities must be made via landline voice communications when operating with the backup RDP only.

4. TERMINAL. Use the “Modify” or “Quick Look” functions for data transfer between the TRACON and tower cab only if specific procedures are established in a facility directive. The local controller has the responsibility to determine whether or not conditions are adequate for the use of ARTS/STARS data on the BRITE/DBRITE/TDW.

No Change

REFERENCE-

FAAO 7210.3, *Use of Modify and Quick Look Functions, Para 11-2-4.*
FAAO 7210.3, *Use of Stars Quick Look Functions, Para 11-8-4.*

No Change

5. EN ROUTE. EDARC/HOST or DARC/HOST have interfacility handoff capabilities that can be manually initiated and accepted through the Quick Action Keys (OAK), or used in automatic handoff mode as in HOST Stage A. DARC or EDARC do not have the capabilities for interfacility handoffs. Therefore, handoffs between facilities must be made via landline voice communications when operating in DARC or EDARC.

Delete

OLD**5-14-3. COMPUTER ENTRY OF ASSIGNED ALTITUDE**

Title through a

b. An interim altitude if the aircraft will (climb or descend to and) maintain the new altitude for a short period of time and subsequently be recleared to the altitude in the flight plan database or a new altitude or a new interim altitude.

NOTE-

1. *Use of the interim altitude function will ensure that the data block reflects the actual status of the aircraft and eliminate superfluous altitude updates.*

2. *EARTS does not have interim altitude capability.*

OLD**5-14-5. SELECTED ALTITUDE LIMITS**

To ensure the display of Mode C targets and data blocks, take the following actions:

NOTE-

Exception to these requirements may be authorized for specific altitudes in certain ARTCC sectors if defined in appropriate facility directives and approved by the regional AT division manager.

NEW**5-14-3. COMPUTER ENTRY OF ASSIGNED ALTITUDE**

No Change

No Change

NOTE-

Use of the interim altitude function will ensure that the data block reflects the actual status of the aircraft and eliminate superfluous altitude updates.

Delete

NEW**5-14-5. SELECTED ALTITUDE LIMITS**

The display of Mode C targets and **limited** data blocks **is necessary for application of Merging Target Procedures. Sectors shall ensure the display of Mode C targets and data blocks by entering appropriate altitude limits and display filters to include, as a minimum, the altitude stratum of the sector plus:**

Delete

a. NAS en route Stage A/DARC, display altitude limits in the “R” CRD when operating on NAS en route Stage A or on the PVD/MDM when operating on DARC and select the display filter keys on the PVD/MDM to include, as a minimum, the altitude stratum of the sector; plus

Delete

1. 1,200 feet above the highest and below the lowest altitude or flight level of the sector where 1,000 feet vertical separation is applicable; and

a. 1,200 feet above the highest and below the lowest altitude or flight level of the sector where 1,000 feet vertical separation is applicable; and

2. 2,200 feet above the highest and below the lowest flight level of the sector where 2,000 feet vertical separation is applicable.

b. 2,200 feet above the highest and below the lowest flight level of the sector where 2,000 feet vertical separation is applicable.

b. EARTS. Display the EARTS altitude filter limits to include, as a minimum, the altitude stratum of the sector; and

Delete

1. 1,200 feet above the highest and below the lowest altitude or flight level of the sector where 1,000 feet vertical separation is applicable; and

Delete

2. 2,200 feet above the highest and below the lowest flight level of the sector where 2,000 feet vertical separation is applicable.

Delete

Add

NOTE-

1. The data block, for purposes of this paragraph, must contain the beacon code and Mode C altitude at a minimum.

2. Exception to these requirements may be authorized for specific altitudes in certain ARTCC sectors if defined in appropriate facility directives and approved by the respective service area operations directorate.

No Change

REFERENCE-
FAAO 7110.65, Alignment Accuracy Check, Para 5-1-2.

OLD

13-1-14. HOST OUTAGES

In the event of a RDP/FDP outage, URET data may be used to support situational awareness while the facility transitions to Enhanced Direct Access Radar Channel (EDARC) or nonradar procedures.

NOTE-
Without Host input, URET data cannot be updated and becomes stale.

NEW

13-1-14. PRIMARY RDP/FDP OUTAGES

In the event of a **primary** RDP/FDP outage, URET data may be used to support situational awareness while the facility transitions to **the backup RDP** or nonradar procedures.

NOTE-
Without **primary system** input, URET data cannot be updated and becomes stale.

4. OPERATIONAL IMPACT: None.

1. PARAGRAPH NUMBER AND TITLE: 2-1-6. SAFETY ALERT

2. BACKGROUND: The Air Traffic Advisory Committee (ATPAC), has recommended that the sequence in which an alert is given to aircraft should be the same. There currently exists an inconsistency in the way in which safety related advisories are issued to aircraft. Paragraph 2-1-6a, relating to terrain/obstruction advisories, states the aircraft identification first, then the alert advisory. Paragraphs 2-1-6c, 5-9-7c2, and 5-9-8c3, relating to traffic alerts, states the alert first, then the aircraft identification. These paragraphs used to have the call sign first followed by the alert, but were changed as a result of data from Precision Radar Monitoring (PRM) evaluations that show that there is a possibility that the call sign could be clipped or the pilot miss hearing it.

3. CHANGE:

<u>OLD</u>	<u>NEW</u>
<p>2-1-6. SAFETY ALERT</p> <p>Title through <i>NOTE</i></p> <p>a. Terrain/Obstruction Alert. Immediately issue/initiate an alert to an aircraft if you are aware the aircraft is at an altitude which, in your judgment, places it in unsafe proximity to terrain/obstructions. Issue the alert as follows:</p> <p>PHRASEOLOGY- <i>(Identification) LOW ALTITUDE ALERT,</i></p> <p><i>CHECK YOUR ALTITUDE IMMEDIATELY.</i></p> <p><i>THE (as appropriate) MEA/MVA/MOCA/MIA IN YOUR AREA IS (altitude),</i></p> <p><i>or if an aircraft is past the final approach fix (nonprecision approach),</i></p> <p><i>or the outer marker,</i></p> <p><i>or the fix used in lieu of the outer marker (precision approach),</i></p> <p><i>and, if known, issue</i></p> <p><i>THE (as appropriate) MDA/DH IS (altitude).</i></p>	<p>2-1-6. SAFETY ALERT</p> <p>No Change</p> <p>No Change</p> <p>PHRASEOLOGY- <i>LOW ALTITUDE ALERT (call sign),</i></p> <p><i>CHECK YOUR ALTITUDE IMMEDIATELY.</i></p> <p><i>THE (as appropriate) MEA/MVA/MOCA/MIA IN YOUR AREA IS (altitude),</i></p> <p><i>or if an aircraft is past the final approach fix (nonprecision approach),</i></p> <p><i>or the outer marker,</i></p> <p><i>or the fix used in lieu of the outer marker (precision approach),</i></p> <p><i>and, if known, issue</i></p> <p><i>THE (as appropriate) MDA/DH IS (altitude).</i></p>

4. OPERATIONAL IMPACT: None.

1. PARAGRAPH NUMBER AND TITLE: 2-1-7. INFLIGHT EQUIPMENT MALFUNCTIONS

2-1-13. FORMATION FLIGHTS

2-1-28. RVSM OPERATIONS

5-1-8. MERGING TARGET PROCEDURES

5-5-8. ADDITIONAL SEPARATION FOR FORMATION FLIGHTS

2. BACKGROUND: The application of Reduced Vertical Separation Minimum (RVSM) is being expanded to include the domestic U.S. airspace.

3. CHANGE:OLD**2-1-7. INFLIGHT EQUIPMENT MALFUNCTIONS**

a. When a pilot reports an inflight equipment malfunction, determine the nature and extent of any special handling desired.

NOTE-

Inflight equipment malfunctions include partial or complete failure of equipment which may affect either safety and/or the ability of the flight to proceed under IFR in the ATC system. Controllers may expect reports from pilots regarding VOR, TACAN, ADF, GPS, or low frequency navigation receivers, impairment of air-ground communications capability, or other equipment deemed appropriate by the pilot (e.g. airborne weather radar). Pilots should communicate the nature and extent of any assistance desired from ATC.

OLD**2-1-13. FORMATION FLIGHTS**

Control formation flights as a single aircraft. When individual control is requested, issue advisory information which will assist the pilots in attaining separation. When pilot reports indicate separation has been established, issue control instructions as required.

NOTE-

1. *Separation responsibility between aircraft within the formation during transition to individual control rests with the pilots concerned until standard separation has been attained.*

2. *Formation join-up and breakaway will be conducted in VFR weather conditions unless prior authorization has been obtained from ATC or individual control has been approved.*

REFERENCE-

FAAO 7110.65, *Additional Separation for Formation Flights*, Para 5-5-8.
P/CG Term- *Formation Flight*.

NEW**2-1-7. INFLIGHT EQUIPMENT MALFUNCTIONS**

No Change

NOTE-

Inflight equipment malfunctions include partial or complete failure of equipment, which may affect either safety, separation standards, and/or the ability of the flight to proceed under IFR, or in Reduced Vertical Separation Minimum (RVSM) airspace, in the ATC system. Controllers may expect reports from pilots regarding VOR, TACAN, ADF, GPS, RVSM capability, or low frequency navigation receivers, impairment of air-ground communications capability, or other equipment deemed appropriate by the pilot (e.g., airborne weather radar). Pilots should communicate the nature and extent of any assistance desired from ATC.

NEW**2-1-13. FORMATION FLIGHTS**

a. Control formation flights as a single aircraft. When individual control is requested, issue advisory information which will assist the pilots in attaining separation. When pilot reports indicate separation has been established, issue control instructions as required.

No Change

No Change

Add	<u>b. Formation flights in RVSM airspace.</u>
Add	<u>1. For a formation flight operating in RVSM airspace, change the equipment suffix of the flight to indicate non-RVSM, regardless of RVSM status.</u>
Add	<u>2. Upon flight breakup, query each aircraft of their RVSM status and make appropriate equipment suffix changes to indicate their status.</u>
<u>OLD</u>	<u>NEW</u>
Add	2-1-28. RVSM OPERATIONS
Add	<u>Controller responsibilities shall include but not be limited to the following:</u>
Add	<u>a. Non-RVSM aircraft operating in RVSM airspace.</u>
Add	<u>1. Ensure non-RVSM aircraft are not permitted in RVSM airspace unless they meet the criteria of excepted aircraft and are previously approved by the operations supervisor/controller-in-charge (CIC). The following aircraft are excepted: DOD, Lifeguard, manufacturer aircraft being flown for development/certification, and Foreign State aircraft. These exceptions are accommodated on a workload or traffic-permitting basis.</u>
Add	<u>NOTE-</u> <u>The operations supervisor/CIC is responsible for system acceptance of a non-RVSM aircraft beyond the initial sector to sector coordination following the pilot request to access the airspace. Operations supervisor/CIC responsibilities are defined in FAA Order 7210.3, Chapter 6, Section 9, Reduced Vertical Separation Minimum (RVSM).</u>
Add	<u>2. Ensure sector-to-sector coordination for all non-RVSM aircraft operations within RVSM airspace.</u>
Add	<u>b. Non-RVSM aircraft transitioning RVSM airspace.</u>
Add	<u>Ensure that operations supervisors/CICs are made aware when non-RVSM aircraft are transitioning through RVSM airspace.</u>
Add	<u>c. Apply appropriate separation standards and remove any aircraft from RVSM airspace that advises it is unable RVSM due to equipment while en route.</u>
Add	<u>d. Use “negative RVSM” in all verbal ground-to-ground communications involving non-RVSM aircraft while cleared to operate within RVSM airspace.</u>
Add	<u>EXAMPLE-</u> <u>“Point out Baxter21 climbing to FL 360, negative RVSM.”</u>

- Add **e. For the following situations, use the associated phraseology:**
- Add **1. To deny clearance into RVSM airspace.**
- Add **PHRASEOLOGY-**
“UNABLE CLEARANCE INTO RVSM AIRSPACE.”
- Add **2. To request a pilot to report when able to resume RVSM.**
- Add **PHRASEOLOGY-**
“REPORT ABLE TO RESUME RVSM.”
- Add **f. In the event of a change to an aircraft’s navigational capability amend the equipment suffix in order to properly identify non-RVSM aircraft on the controller display.**

OLD

5-1-8. MERGING TARGET PROCEDURES

Title through a

b. Issue traffic information to those aircraft listed in subpara a whose targets appear likely to merge unless the aircraft are separated by more than the appropriate vertical separation minima.

EXAMPLE-

“Traffic twelve o’clock, seven miles, eastbound, MD-80, at one seven thousand.”

“United Sixteen and American Twenty-five, traffic twelve o’clock, one zero miles, opposite direction, eastbound seven twenty seven at flight level three three zero, westbound MD-Eighty at flight level three one zero.”

Add

Add

c. If the pilot requests, vector his/her aircraft to avoid merging with the target of previously issued traffic.

NOTE-

Aircraft closure rates are so rapid that when applying merging target procedures, controller issuance of traffic must be commenced in ample time for the pilot to decide if a vector is necessary.

NEW

5-1-8. MERGING TARGET PROCEDURES

No Change

No Change

No Change

c. When both aircraft in subpara b are in RVSM airspace, and vertically separated by 1,000 feet, if either pilot reports they are unable to maintain RVSM due to turbulence or mountain wave, vector either aircraft to avoid merging with the target of the other aircraft.

EXAMPLE-

“Delta One Twenty Three, fly heading two niner zero, vector for traffic. Traffic twelve o’clock, one zero miles, opposite direction, MD-80 eastbound at flight level three two zero.”

d. If the pilot requests, vector his/her aircraft to avoid merging with the target of previously issued traffic.

No Change

d. If unable to provide vector service, inform the pilot.

Add

e. If unable to provide vector service, inform the pilot.

NOTE-

The phraseology “Unable RVSM due turbulence (or mountain wave)” is only intended for severe turbulence or other weather encounters with altitude deviations of approximately 200 feet or more.

OLD

5-5-8. ADDITIONAL SEPARATION FOR FORMATION FLIGHTS

Because of the distance allowed between formation aircraft and lead aircraft, additional separation is necessary to ensure the periphery of the formation is adequately separated from other aircraft, adjacent airspace, or obstructions. Provide supplemental separation for formation flights as follows:

a. Separate a standard formation flight by adding 1 mile to the appropriate radar separation minima.

REFERENCE-

FAAO 7110.65, Formation Flights, Para 2-1-13.

FAAO 7110.65, Application, Para 5-5-1.

FAAO 7110.65, Separation, Para 7-7-3.

P/CG Term- Formation Flight.

b. Separate two standard formation flights from each other by adding 2 miles to the appropriate separation minima.

c. Separate a nonstandard formation flight by applying the appropriate separation minima to the perimeter of the airspace encompassing the nonstandard formation or from the outermost aircraft of the nonstandard formation whichever applies.

Add

Add

NEW

5-5-8. ADDITIONAL SEPARATION FOR FORMATION FLIGHTS

No Change

No Change

No Change

No Change

No Change

NOTE-

Aircraft operating in a formation flight are considered non-RVSM aircraft regardless of their single-ship status.

REFERENCE-

FAAO 7110.65, Vertical Separation Minima, Para 4-5-1.

4. OPERATIONAL IMPACT: None.

1. PARAGRAPH NUMBER AND TITLE: 2-3-7. AIRCRAFT EQUIPMENT SUFFIX

2. BACKGROUND: The vertical separation minimum at flight levels 290 thru 410 has been reduced from 2000 feet to 1000 feet within many areas of the world. This reduced vertical separation minimum will also become effective within the domestic United States and specified adjoining airspace on January 20, 2005.

3. CHANGE:

<u>OLD</u>	<u>NEW</u>
2-3-7. AIRCRAFT EQUIPMENT SUFFIX	2-3-7. AIRCRAFT EQUIPMENT SUFFIX
Title through bEXAMPLE	No Change

OLD
TBL 2-3-7
Aircraft Equipment Suffixes

Suffix	Aircraft Equipment Suffixes
	NO DME
/X	No transponder
/T	Transponder with no Mode C
/U	Transponder with Mode C
	DME
/D	No transponder
/B	Transponder with no Mode C
/A	Transponder with Mode C
	TACAN ONLY
/M	No transponder
/N	Transponder with no Mode C
/P	Transponder with Mode C
	AREA NAVIGATION (RNAV)
/Y	LORAN, VOR/DME, or INS with no transponder
/C	LORAN, VOR/DME, or INS, transponder with no Mode C
/I	LORAN, VOR/DME, or INS, transponder with Mode C
	ADVANCED RNAV WITH TRANSPONDER AND MODE C (If an aircraft is unable to operate with a transponder and/or Mode C, it will revert to the appropriate code listed above under Area Navigation.)
/E	<u>Flight Management System (FMS) with en route, terminal, and approach capability. Equipment requirements are:</u> <u>(a) Dual FMS which meets the specifications of AC 25-15, Approval of Flight Management Systems in Transport Category Airplanes; AC 20-129, Airworthiness Approval of Vertical Navigation (VNAV) Systems for use in the U.S. NAS and Alaska; AC 20-130A, Airworthiness Approval of Navigation or Flight Management Systems Integrating Multiple Navigation Sensors; or equivalent criteria as approved by Flight Standards.</u> <u>(b) A flight director and autopilot control system capable of following the lateral and vertical FMS flight path.</u> <u>(c) At least dual inertial reference units (IRUs).</u> <u>(d) A database containing the waypoints and speed/altitude constraints for the route and/or procedure to be flown that is automatically loaded into the FMS flight plan.</u> <u>(e) An electronic map.</u> <u>(U.S. and U.S. territories only unless otherwise authorized.)</u>
/F	<u>FMS with en route, terminal, and approach capability. Unless otherwise authorized by the Administrator, equipment requirements are:</u> <u>(a) Single FMS which meets the specifications of AC 25-15, Approval of Flight Management Systems in Transport Category Airplanes; AC 20-129, Airworthiness Approval of Vertical Navigation (VNAV) Systems for use in the U.S. NAS and Alaska; AC 20-130A, Airworthiness Approval of Navigation or Flight Management Systems Integrating Multiple Navigation Sensors; or equivalent criteria as approved by Flight Standards.</u> <u>(b) A demonstrated capability of depicting and following the lateral and vertical path.</u> <u>(c) An FMS with DME/DME updating and one or more of the following: Single Global Positioning System (GPS) – Single inertial reference unit (IRU).</u> <u>(d) A database containing the waypoints and speed/altitude constraints for the route and/or procedure to be flown that is automatically loaded into the FMS flight plan.</u> <u>(U.S. and U.S. territories only unless otherwise authorized.)</u>

/G	<u>GPS/Global Navigation Satellite System (GNSS) equipped aircraft</u> with en route and terminal capability
/R	Required Navigational Performance (<u>Denotes capability to operate in Required Navigation Performance (RNP) designated airspace and routes</u>)
/W	<u>Reduced Vertical Separation Minima (RVSM)</u>
/Q	<u>RNP and RVSM (Indicate approval for application of RNP and RVSM separation standards.) It should be noted that /Q is for automation purposes only and will not be filed by system users. FAA processors will convert the combination of /R+/W to =/Q.</u>

NEW
TBL 2-3-7
Aircraft Equipment Suffixes

Suffix	Aircraft Equipment Suffixes
	NO DME
/X	No transponder
/T	Transponder with no Mode C
/U	Transponder with Mode C
	DME
/D	No transponder
/B	Transponder with no Mode C
/A	Transponder with Mode C
	TACAN ONLY
/M	No transponder
/N	Transponder with no Mode C
/P	Transponder with Mode C
	AREA NAVIGATION (RNAV)
/Y	LORAN, VOR/DME, or INS with no transponder
/C	LORAN, VOR/DME, or INS, transponder with no Mode C
/I	LORAN, VOR/DME, or INS, transponder with Mode C
	ADVANCED RNAV WITH TRANSPONDER AND MODE C (If an aircraft is unable to operate with a transponder and/or Mode C, it will revert to the appropriate code listed above under Area Navigation.)
/E	<u>Flight Management System (FMS) with DME/DME and IRU position updating</u>
/F	<u>Flight Management System (FMS) with DME/DME position updating</u>
/G	Global Navigation Satellite System (GNSS), <u>including GPS or WAAS</u> , with en route and terminal capability
/R	Required Navigational Performance. <u>The aircraft meets the RNP type prescribed for the route segment(s), route(s) and/or area concerned.</u>
	<u>REDUCED VERTICAL SEPARATION MINIMUM (RVSM). Prior to conducting RVSM operations within the U.S., the operator must obtain authorization from the FAA or from the responsible authority, as appropriate.</u>
<u>/I</u>	<u>/E with RVSM</u>
<u>/K</u>	<u>/F with RVSM</u>
<u>/L</u>	<u>/G with RVSM</u>
/Q	<u>/R with RVSM</u>
/W	RVSM

4. OPERATIONAL IMPACT: None.

1. PARAGRAPH NUMBER AND TITLE: 4-4-6. DIRECT CLEARANCES

2. BACKGROUND: Through collaborative decision-making it was determined that pilot requested or controller initiated direct clearances impact data integrity, system predictability and performance. Maintaining route integrity during periods of system constraint is essential to predictable and accurate traffic management initiatives, schedule integrity, and reducing controller complexity and workload.

3. CHANGE:

<u>OLD</u>	<u>NEW</u>
Add	<u>4-4-6. DIRECT CLEARANCES</u>
Add	<u>a. Do not issue a routing clearance that will take an aircraft off of its flight plan route if the destination airport is included in a ground delay program (GDP), ground stop (GS), or Playbook route, when known, unless operational necessity dictates.</u>
Add	<u>b. EN ROUTE. Do not issue revised routing clearances that will take an aircraft off its flight plan route past the last fix in your facility’s airspace, unless requested by the pilot or operational necessity dictates.</u>
Add	<u>NOTE- Nothing in this paragraph shall preclude a controller from issuing a routing clearance that conforms to a letter of agreement or standard operating procedure within their own facility or between facilities, is required to maintain separation or comply with traffic flow management initiatives.</u>

4. OPERATIONAL IMPACT: Minor.

1. PARAGRAPH NUMBER AND TITLE: 4-5-1. VERTICAL SEPARATION MINIMA

2. BACKGROUND: This change incorporates the 1,000 feet vertical separation up to and including FL 410. It also provides for 2,000 feet vertical separation between aircraft in Reduced Vertical Separation Minimum (RVSM) airspace when one of the aircraft is non-RVSM. The application of RVSM is being expanded to include the domestic U.S. airspace.

3. CHANGE:

<u>OLD</u>	<u>NEW</u>
4-5-1. VERTICAL SEPARATION MINIMA	4-5-1. VERTICAL SEPARATION MINIMA
Separate instrument flight rules (IFR) aircraft using the following minima between altitudes:	No Change
a. Up to and including <u>FL 290</u>- 1,000 feet.	a. Up to and including <u>FL 410</u>- 1,000 feet.
Add	<u>b. Apply 2,000 feet at or above FL 290 between non-RVSM aircraft and all other aircraft at or above FL 290.</u>
Add	<u>NOTE- Aircraft operating in a formation flight are considered non-RVSM aircraft regardless of their single-ship status.</u>

Add

b. Above FL 290 – 2,000 feet, except:

1. In oceanic airspace, above FL 450 between a supersonic and any other aircraft– 4,000 feet.

2. Above FL 600 between military aircraft– 5,000 feet.

3. Apply 1,000 feet between approved aircraft if:

(a) Operating within airspace and altitude(s) designated for reduced vertical separation minimum (RVSM) or.

(b) Operating within RVSM transition airspace and designated altitude(s).

NOTE–

1. *Oceanic separation procedures are supplemented in Chapter 8; Section 7, Section 8, Section 9, and Section 10.*

2. *RVSM and RVSM transition airspace is designated in ICAO Regional Supplementary Document, Doc. 7030.4, and via International NOTAM.*

REFERENCE–

FAAO 7110.65, Vertical Application, Para 5–5–5.

FAAO 7110.65, Application, Para 6–6–1.

FAAO 7110.65, Military Operations Above FL 600, Para 9–3–13.

REFERENCE–

FAAO 7110.65, Formation Flights, Para 2–1–13.

FAAO 7110.65, Additional Separation for Formation Flights, Para 5–5–8.

P/CG Term – Formation Flight.

c. Above FL 410 – 2,000 feet, except:

No Change

No Change

Delete

Delete

Delete

NOTE–

Oceanic separation procedures are supplemented in Chapter 8; Section 7, Section 8, Section 9, and Section 10.

Delete

No Change

4. OPERATIONAL IMPACT: None.

1. PARAGRAPH NUMBER AND TITLE: 4–5–2. FLIGHT DIRECTION

2. BACKGROUND: The application of Reduced Vertical Separation Minimum (RVSM) is being expanded to include the domestic U.S. airspace.

3. CHANGE:

OLD

4–5–2. FLIGHT DIRECTION

Clear aircraft at altitudes according to the TBL 4–5–1.

NEW

4–5–2. FLIGHT DIRECTION

No Change

**TBL 4-5-1
Altitude Assignment**

Aircraft Operating	On course degrees magnetic	Assign	Examples
Below 3,000 feet above surface	Any course	Any altitude	
<u>Below FL 290</u>	0 through 179	Odd cardinal altitude or flight levels at intervals of 2,000 feet	3,000 5,000, <u>FL 250</u> , <u>FL 270</u>
	180 through 359	Even cardinal altitude or flight levels at intervals of 2,000 feet	4,000, 6000, <u>FL 240</u> , <u>FL 260</u>
<u>At or above FL 290</u>	0 through 179	Odd cardinal flight levels at intervals of 4,000 feet beginning with <u>FL 290</u>	<u>FL 290</u> , <u>FL 330</u> , <u>FL 370</u>
	180 through 359	Odd cardinal flight levels at intervals of 4,000 feet beginning with <u>FL 310</u>	<u>FL 310</u> , <u>FL 350</u> , <u>FL 390</u>
One way routes (except in composite systems)	Any course	Any cardinal altitude or flight level below <u>FL 290</u> or any odd cardinal flight level <u>at or above FL 290</u>	FL 270, FL 280, FL 310, <u>FL 330</u>
Within an ALTRV	Any course	Any altitude or flight level	
In transition to/from or within Oceanic airspace where composite separation is authorized	Any course	Any odd or even cardinal flight level including those above FL 290	FL 280, FL 290, FL 300, FL 310, FL 320, FL 330, FL 340
In aerial refueling tracks and anchors	Any course	Altitude blocks as requested. Any altitude or flight level	050B080, FL 180B220, FL 280B310
Aircraft within RVSM or RVSM transition airspace	Any course	Any designated cardinal altitude	FL 330, FL 340, FL 350, FL 360

**TBL 4-5-1
Altitude Assignment**

Aircraft Operating	On course degrees magnetic	Assign	Examples
Below 3,000 feet above surface	Any course	Any altitude	
<u>At and below FL 410</u>	0 through 179	Odd cardinal altitude or flight levels at intervals of 2,000 feet	3,000, 5,000, <u>FL 310</u> , <u>FL 330</u>
	180 through 359	Even cardinal altitude or flight levels at intervals of 2,000 feet	4,000, 6,000, <u>FL 320</u> , <u>FL 340</u>
<u>Above FL 410</u>	0 through 179	Odd cardinal flight levels at intervals of 4,000 feet beginning with <u>FL 450</u>	<u>FL 450</u> , <u>FL 490</u> , <u>FL 530</u>
	180 through 359	Odd cardinal flight levels at intervals of 4,000 feet beginning with <u>FL 430</u>	<u>FL 430</u> , <u>FL 470</u> , <u>FL 510</u>
One way routes (except in composite systems)	Any course	Any cardinal altitude or flight level below <u>FL 410</u> or any odd cardinal flight level above <u>FL 410</u>	FL 270, FL 280, <u>FL 290</u> , <u>FL 300</u> , FL 310, <u>FL 410</u> , <u>FL 430</u> , <u>FL 450</u>
Within an ALTRV	Any course	Any altitude or flight level	
In transition to/from or within Oceanic airspace where composite separation is authorized	Any course	Any odd or even cardinal flight level including those above FL 290	FL 280, FL 290, FL 300, FL 310, FL 320, FL 330, FL 340
In aerial refueling tracks and anchors	Any course	Altitude blocks as requested. Any altitude or flight level	050B080, FL 180B220, FL 280B310
Aircraft within <u>Oceanic RVSM</u> or RVSM transition airspace	Any course	Any designated cardinal altitude	FL 330, FL 340, FL 350, FL 360

NOTE-

Oceanic separation procedures are supplemented in Chapter 8; Section 7, Section 8, Section 9, and Section 10.

No Change

REFERENCE-

FAAO 7110.65, *Exceptions, Para 4-5-3.*
FAAO 7110.65, *Altitude Assignments, Para 7-7-5.*
FAAO 7110.65, *Separation Minima, Para 9-4-2.*

No Change

4. OPERATIONAL IMPACT: This change incorporates the six additional cardinal altitudes available with the implementation of RVSM and provides the proper altitude for direction of flight.

1. PARAGRAPH NUMBER AND TITLE: 4-5-3. EXCEPTIONS

2. BACKGROUND: The application of Reduced Vertical Separation Minimum (RVSM) is being expanded to include the domestic U.S. airspace.

3. CHANGE:**OLD****4-5-3. EXCEPTIONS**

When traffic, meteorological conditions, or aircraft operational limitations prevent assignment of altitudes prescribed in para 4-5-2, Flight Direction, assign any cardinal altitude or flight level below FL 290 or any odd cardinal flight level at or above FL 290 without regard to direction of flight as follows:

NEW**4-5-3. EXCEPTIONS**

When traffic, meteorological conditions, or aircraft operational limitations prevent assignment of altitudes prescribed in para 4-5-2, Flight Direction, assign any cardinal altitude or flight level below **FL 410** or any odd cardinal flight level at or above **FL 410** without regard to direction of flight as follows:

4. OPERATIONAL IMPACT: None.

1. PARAGRAPH NUMBER AND TITLE: 5-5-7. PASSING OR DIVERGING

2. BACKGROUND: Paragraph 5-5-7, Passing or Diverging, has undergone numerous interpretations and revisions of interpretations over the years. This has resulted in facilities using conflicting procedures, and many of these procedures have been incorporated into facility standard operating practices.

3. CHANGE:**OLD****5-5-7. PASSING OR DIVERGING**

a. **TERMINAL.** Vertical separation between aircraft may be discontinued when the following conditions are met:

1. Aircraft are on opposite/reciprocal courses and you have observed that they have passed each other; or aircraft are on same or crossing courses and one aircraft has crossed the projected course of the other and the angular difference between their courses is at least 15 degrees.

2. The tracks are monitored to ensure that the primary targets, beacon control slashes, or full digital terminal system primary and/or beacon target symbols will not touch.

NEW**5-5-7. PASSING OR DIVERGING**

a. **TERMINAL.** **In accordance with the following criteria, all other approved separation may be discontinued, and passing or diverging separation applied when:**

No Change

No Change

REFERENCE-
FAAO 7110.65, *Course Definitions, Para 1-2-2.*

No Change

Add

NOTE-
Although all other approved separation may be discontinued, the requirements of para 5-5-4, Minima, subparas e and f shall apply when operating behind a heavy jet/B757.

4. OPERATIONAL IMPACT: None.

1. PARAGRAPH NUMBER AND TITLE: 5-14-2. EN ROUTE MINIMUM SAFE ALTITUDE WARNING (E-MSAW)

2. BACKGROUND: A recent aircraft incident necessitated a review of paragraphs pertaining to En Route Minimum Safe Altitude Warning (E-MSAW). As a result the changes concerning “if necessary” were introduced.

Additionally, the En Route Automation System (EAS) evolved over the years from broadband radar and a separate mainframe computer-based flight data processor to a complex integrated environment consisting of display systems, digitized radar data processing, remote devices, decision support tools, etc. This order reflects parts of this evolution by referring to the EAS and/or various components by various names. References are made to NAS, NAS Stage A, Stage A, Narrowband, Host, EDARC, DARC, and PVD/MDM for example. The current en route backup radar data processor, DARC, is being replaced by a system based on MEARTS software. However, this new DARC system will not always function the same as the MEARTS currently referenced in this order. References to equipment were reviewed in light of the new system and where possible changes were made so that references to equipment are more consistent throughout the order.

3. CHANGE:

OLD

5-14-2. EN ROUTE MINIMUM SAFE ALTITUDE WARNING (E-MSAW)

a. When an E-MSAW alert is displayed, immediately analyze the situation and, if necessary, take the appropriate action to resolve the alert.

NOTE-

1. *Caution should be exercised when issuing a clearance to an aircraft in reaction to an E-MSAW alert to ensure that adjacent MIA areas are not a factor.*

2. *DARC does not have E-MSAW capability.*

REFERENCE-
FAAO 7110.65, *Safety Alert, Para 2-1-6*

NEW

5-14-2. EN ROUTE MINIMUM SAFE ALTITUDE WARNING (E-MSAW)

a. When an E-MSAW alert is displayed, immediately analyze the situation and take the appropriate action to resolve the alert.

NOTE-

Caution should be exercised when issuing a clearance to an aircraft in reaction to an E-MSAW alert to ensure that adjacent MIA areas are not a factor.

Delete

No Change

4. OPERATIONAL IMPACT: None.

1. PARAGRAPH NUMBER AND TITLE: 9-5-4. SEPARATION MINIMA

2. BACKGROUND: The application of Reduced Vertical Separation Minimum (RVSM) is being expanded to include the domestic U.S. airspace.

3. CHANGE:

<u>OLD</u>	<u>NEW</u>
9-5-4. SEPARATION MINIMA	9-5-4. SEPARATION MINIMA
Separate known aircraft from the aircraft dumping fuel as follows:	No Change
a. IFR aircraft by one of the following:	No Change
1. <i>1,000 feet</i> (<i>2,000 feet</i> above FL 290) above it.	1. <i>1,000 feet</i> above it; <u>or in accordance with para 4-5-1, Vertical Separation Minima, whichever is greater.</u>
2. <i>2,000 feet</i> below it.	No Change
3. <i>5 miles</i> radar.	No Change
4. <i>5 miles</i> laterally.	No Change
b. VFR radar-identified aircraft by <i>5 miles</i> and in accordance with para 5-6-1, Application.	No Change

4. OPERATIONAL IMPACT: The change to this paragraph incorporates the 1,000 feet separation between altitudes up to FL 410 in the provisions associated with fuel dumping.

1. PARAGRAPH NUMBER AND TITLE: APPENDIX A. AIRCRAFT INFORMATION

2. BACKGROUND: Appendix A includes information on fixed-wing aircraft including aircraft type designators, manufacturers, description of number and type of engines, aircraft weight classes, climb and descent rates, and same runway separation. Information from FAA Order 7110.118, Land and Hold Short Operations (LAHSO), Appendix 1, LAHSO Aircraft Landing Distances, is incorporated in the performance data by including the LAHSO aircraft group.

3. CHANGE:

<u>OLD</u>	<u>NEW</u>
APPENDIX A. AIRCRAFT INFORMATION	APPENDIX A. AIRCRAFT INFORMATION
	See Appendix A for specific changes.

4. OPERATIONAL IMPACT: None.